



# BLADDERSCAN PRIME PLUS

## OPERATIONS & MAINTENANCE MANUAL



# BLADDERSCAN PRIME PLUS

## OPERATIONS & MAINTENANCE MANUAL

Effective: October 5, 2022

Caution: Federal (United States) law restricts this device to sale by or on the order of a physician.

# CONTACT INFORMATION

To obtain additional information regarding your BladderScan system, please contact Verathon Customer Care or visit [verathon.com/service-and-support](https://www.verathon.com/service-and-support).



## Verathon Inc.

20001 North Creek Parkway  
Bothell, WA 98011 U.S.A.  
Tel: +1 800 331 2313 (US and Canada only)  
Tel: +1 425 867 1348  
Fax: +1 425 883 2896  
[verathon.com](https://www.verathon.com)



## Verathon Medical (Europe) B.V.

Willem Fenengastraat 13  
1096 BL Amsterdam  
The Netherlands  
Tel: +31 (0) 20 210 30 91  
Fax : +31 (0) 20 210 30 92

## Verathon Medical (Australia) Pty Limited

Unit 9, 39 Herbert Street  
St Leonards NSW 2065  
Australia  
Within Australia: 1800 613 603 Tel / 1800 657 970 Fax  
International: +61 2 9431 2000 Tel /  
+61 2 9475 1201 Fax



## MDSS CH GmbH

Laurenzenvorstadt 61  
5000 Aarau  
Switzerland



## Anandic Medical Systems AG

Stadtweg 24  
8245 Feuerthalen  
Switzerland

CE 0123

Copyright © 2022 Verathon, Inc. All rights reserved.

BladderScan, the BladderScan symbol, BladderTraq, CaliScan, ImageSense, V<sub>MODE</sub>, Verathon, and the Verathon Torch symbol are trademarks of Verathon Inc. All other brand and product names are trademarks or registered trademarks of their respective owners.

Not all Verathon Inc. products shown or described in this manual are available for commercial sale in all countries.

Information in this manual may change at any time without notice. For the most up-to-date information, see the documentation available at [verathon.com/service-and-support](https://www.verathon.com/service-and-support).

# TABLE OF CONTENTS

---

<b>IMPORTANT INFORMATION .....</b>	<b>1</b>
OVERVIEW .....	1
Product Description.....	1
Statement of Intended Use .....	1
Notice to All Users.....	1
Essential Performance.....	1
Environments of Intended Use .....	1
HIPAA Privacy .....	2
SAFETY INFORMATION.....	2
Ultrasound Energy Safety.....	2
Contraindications .....	2
Warnings & Cautions .....	2
<b>INTRODUCTION.....</b>	<b>8</b>
SYSTEM OVERVIEW.....	8
Components & Accessories.....	9
SYSTEM FEATURES .....	11
Console Features.....	11
Probe Features .....	12
Battery & Battery Charger Features.....	13
SYSTEM ICONS .....	13
Console Touchscreen Icons.....	13
Console Battery Level Icons.....	15
Probe Icons .....	15

<b>SETTING UP</b> .....	<b>16</b>
ASSEMBLING THE INSTRUMENT .....	16
<i>Procedure 1. Perform the Initial Inspection</i> .....	16
<i>Procedure 2. Charge the Battery</i> .....	17
<i>Procedure 3. Attach the Probe to the Console</i> .....	19
<i>Procedure 4. Attach the Console Base or Printer</i> .....	20
<i>Procedure 5. Attach the System to the Mobile Cart (Optional)</i> .....	21
<i>Procedure 6. Install the Port Cover (Optional)</i> .....	24
<i>Procedure 7. Insert a Battery</i> .....	25
CONFIGURING SETTINGS .....	26
<i>Procedure 1. Configure General Settings</i> .....	26
<i>Procedure 2. Configure Exam Settings</i> .....	28
<i>Procedure 3. Customize Cost Savings Calculations</i> .....	29
<i>Procedure 4. Configure Printed and PDF Report Settings</i> .....	30
<i>Procedure 5. Configure a PIN for Saved Scans</i> .....	31
<i>Procedure 6. Configure a PIN for System Settings</i> .....	32
<b>USING THE INSTRUMENT</b> .....	<b>33</b>
MEASURING BLADDER VOLUME .....	33
<i>Procedure 1. Prepare for the Exam</i> .....	33
<i>Procedure 2. Input Patient Information or Operator ID (Optional)</i> .....	34
<i>Procedure 3. Measure Bladder Volume</i> .....	35
<i>Procedure 4. Review Exam Results</i> .....	37
<i>Procedure 5. Print, Save, or Exit an Exam</i> .....	40
<i>Procedure 6. View Cost Savings</i> .....	40
MANAGING SAVED EXAMS .....	41
<i>Procedure 1. Recall a Saved Exam</i> .....	41
<i>Procedure 2. Delete a Saved Exam</i> .....	42
<i>Procedure 3. Export Saved Exams</i> .....	43

**CLEANING & DISINFECTING .....44**

- CLEANERS & DISINFECTANTS .....44
  - Disinfection Efficacy .....44
  - Compatibility .....45
- BEST PRACTICES & INSTRUCTIONS .....45
  - Procedure 1. Clean & Disinfect the System*.....46

**MAINTENANCE & SAFETY .....47**

- REGULAR INSPECTIONS .....47
- CALIBRATION .....47
- SYSTEM SOFTWARE .....47
- DEVICE DISPOSAL .....47
- WARRANTY .....47
- MAINTENANCE PROCEDURES .....48
  - Procedure 1. Load Thermal Paper into the Printer*.....48
  - Procedure 2. Run a Self-Test*.....49
  - Procedure 3. Update the Software*.....50
  - Procedure 4. Complete a CaliScan Test*.....51

**HELP & TROUBLESHOOTING .....52**

- HELP RESOURCES .....52
  - Procedure 1. Watch the Onboard Tutorial* .....52
- DEVICE REPAIR .....53
- TROUBLESHOOTING PROCEDURES .....53
  - Procedure 1. Troubleshoot Console Power Issues* .....53
  - Procedure 2. Troubleshoot Probe Connection Issues*.....54
  - Procedure 3. Troubleshoot Probe Aiming Issues* .....54
  - Procedure 4. Restore Factory Defaults*.....55
  - Procedure 5. Troubleshoot Printer Power Issues*.....56
  - Procedure 6. Troubleshoot Irregular Printouts*.....57
  - Procedure 7. Clear a Paper Jam* .....60
  - Procedure 8. Replace the Printer Drive Roller*.....61

<b>PRODUCT SPECIFICATIONS</b> .....	<b>62</b>
SYSTEM SPECIFICATIONS .....	62
COMPONENT SPECIFICATIONS .....	65
ELECTROMAGNETIC COMPATIBILITY .....	68
<b>GLOSSARY</b> .....	<b>72</b>



# IMPORTANT INFORMATION

---

## OVERVIEW

### PRODUCT DESCRIPTION

The BladderScan Prime Plus instrument provides noninvasive measurement of urinary bladder volume. The instrument calculates the bladder volume using patented neural network technology. Volume measurements made with this technology are based on a more complex, multifaceted image of the bladder.

The primary components of the system are a console and probe. The console features a touch screen that displays the bladder volume, directional aiming with real-time feedback, settings, battery status and usage rate indicators. Stored exams can be accessed at any time using the console display. The system also includes a battery charger for the custom, user-replaceable lithium-ion batteries included with the system.

### STATEMENT OF INTENDED USE

The BladderScan Prime Plus system is an ultrasound device intended to be used for measuring the urine volume in the bladder noninvasively.

### NOTICE TO ALL USERS

The BladderScan Prime Plus system should be used only by individuals who have been trained and authorized by a physician or the institution providing patient care. Users should read this entire manual prior to using the system. Do not attempt to operate this instrument until you thoroughly understand all instructions and procedures in this manual.

### ESSENTIAL PERFORMANCE

*Essential performance* is the system performance necessary to achieve freedom from unacceptable risk. The essential performance of the BladderScan Prime Plus system is to produce ultrasonic output energy, display ultrasonic images, and display numerical values for bladder volume. The instrument shall not produce unintended or excessive probe surface temperature.

### ENVIRONMENTS OF INTENDED USE

The BladderScan Prime Plus system is intended to be used in professional healthcare environments such as hospitals, clinics, and doctors' offices.

## HIPAA PRIVACY

The Health Insurance Portability and Accountability Act of 1996 (“HIPAA”) regulations require our customers to monitor and limit the ways in which patients’ confidential information is accessed, utilized, stored, transmitted, and disposed. Our customers are ultimately responsible for ensuring all electronic health information contained within the system is protected. In the course of providing services to customers, Verathon will remove all electronic protected health information from the system if present.

## SAFETY INFORMATION

### ULTRASOUND ENERGY SAFETY

To date, exposure to pulsed diagnostic ultrasound has not been shown to produce adverse effects. However, ultrasound should be used prudently, and total patient exposure should be kept *as low as reasonably achievable* (ALARA). Following the ALARA principle, ultrasound should only be used by medical professionals when clinically indicated, using the lowest possible exposure times necessary to obtain clinically useful information. For more information on ALARA, please refer to the American Institute of Ultrasound in Medicine publication, *Medical Ultrasound Safety*.

The ultrasound output power of the BladderScan Prime Plus system is not user adjustable and is limited to the minimum level necessary for effective performance. For more information about acoustic output levels, see the [Product Specifications](#) chapter on page 62.

### CONTRAINDICATIONS

The BladderScan Prime Plus system is not intended for fetal use or for use on pregnant patients, patients with open skin or wounds in the suprapubic region, or patients with ascites.

### WARNINGS & CAUTIONS

*Warnings* indicate that injury, death, or other serious adverse reactions may result from use or misuse of the device. *Cautions* indicate that use or misuse of the device may cause a problem, such as a malfunction, failure, or damage to the product. Throughout the manual, pay attention to sections labeled *Important*, as these contain reminders or summaries of the following cautions as they apply to a specific component or use situation. Please heed the following warnings and cautions.

#### WARNINGS



#### WARNING

Do not use the system on:

- Fetal patients.
- Pregnant patients.
- Patients with open skin or wounds in the suprapubic region.
- Patients with ascites.



### WARNING

Be aware of the following conditions that can affect ultrasound transmission:

- Catheterization—A catheter in the patient's bladder may affect the accuracy of the bladder volume measurement in two ways: 1) by introducing air into the bladder that may block the ultrasound signal, and 2) by having the catheter-retaining balloon interfere with the volume measurement. However, the volume measurement may still be clinically useful if it is large (detecting a blocked catheter, for example).
- Abdominal Surgery—Scar tissue, surgical incisions, sutures, and staples can affect ultrasound transmission. Use care when scanning patients who have had abdominal surgery.



### WARNING

Accuracy is compromised if you do not obtain an optimal, repeatable image.



### WARNING

Anatomical features surrounding the bladder can interfere with accurate scanning. When aiming the probe, ensure that the entire bladder is in view and centered.



### WARNING

This product may only be cleaned and disinfected by using the approved processes provided in this manual. Cleaning and disinfection methods listed are recommended by Verathon based on compatibility with component materials.



### WARNING

Cleaning is critical to ensuring the component is ready for disinfection. Failure to properly clean the device could cause contamination to remain after the disinfection procedure is complete.



### WARNING

Ensure that you follow the manufacturer's instructions for handling and disposing of the cleaning and disinfection solutions provided in this manual.



### WARNING

To reduce the risk of explosion, do not use the system in the presence of flammable anesthetics.



### WARNING

To reduce the risk of electric shock or burns, do not use the system in conjunction with high-frequency surgical equipment.



### WARNING

Use of accessories, transducers, and cables other than those specified or provided by Verathon may cause this system to experience electromagnetic malfunctions, including increased emissions or decreased immunity. This may cause improper operation, procedure delays, or both.



### WARNING

Portable radio frequency communications equipment (including peripherals such as antenna cables and external antennas) may not be used within 30 cm (12 inches) of any part of the BladderScan Prime Plus system, including cables that Verathon specifies or provides for use with the system. If this distance is not maintained, performance of the system may be degraded and image display may be compromised.



### WARNING

To reduce the risk of leakage, explosion, fire, or serious injury, note the following when handling the lithium-ion battery included in the system:

- Do not store the battery in the console for an extended period of time.
- Never short-circuit the battery by bringing the battery terminals into contact with any other conductive object.
- Never expose the battery to abnormal shock, vibration, or pressure.
- Do not clean or disinfect the battery using any of the cleaning or disinfection methods described in this manual.
- Do not disassemble, heat above 60°C (140°F), or incinerate the battery.
- Keep battery out of reach of children and in original package until ready to use.
- Dispose of used batteries promptly according to local recycling or waste regulations.
- If the battery is leaking or its case is cracked, put on protective gloves to handle it, and discard it immediately.
- Put insulating tape, such as cellophane tape, on the electrodes during transportation.



### WARNING

In order to maintain electrical safety, use only the provided power supply, battery, and battery charger. Connect the power cord and power adapter to a properly grounded plug, and ensure the disconnect is easily accessible. Use only the accessories and peripherals recommended by Verathon.



### WARNING

To reduce the risk of electrical shock, do not attempt to open the system components. This may cause serious injury to the operator or damage to the instrument and will void the warranty. Contact Verathon Customer Care or your local representative for all servicing needs.



### WARNING

To maintain electrical safety, inspect the battery charger for damage prior to each use. Do not use a battery charger with cracks or other damage. If the battery charger is damaged, contact Verathon Customer Care or your local representative.



### WARNING

No modification of this equipment is allowed.



### WARNING

The battery charger, power adapter, and power cables are not intended for patient contact. Ensure 2 m (6 ft) are maintained between the patient and these components.



### WARNING

To avoid the risk of injury, when the printer door is open:

- Do not touch the printer mechanism or print head, which may be hot from recent printing.
- Do not touch the surface of the paper cutter.



### WARNING

Never use the BladderScan Prime Plus system to display the image of anatomical features other than the bladder.



### WARNING

This system is not a diagnostic device and is only intended as a measuring tool.



### WARNING

Use only a passive-type USB flash drive or SD card. Do not use USB or SD drives powered by an external source.

## CAUTIONS



### CAUTION

Statement of Prescription: Federal (United States) law restricts this device to sale by or on the order of a physician.



### CAUTION

The console USB and SD ports are designed to support removable storage media. Do not attempt to use these ports with other devices. Use the USB ports only with USB flash drives supplied by Verathon.



### CAUTION

To avoid damage to cables and accessories, do not excessively twist or bend cables associated with the system.



### CAUTION

To dispose of the instrument or accessories at the end of their useful service life, see the section “Device Disposal”. The system and related devices may contain mineral oils, batteries, and other environmentally hazardous materials.



### CAUTION

Ensure that the system’s battery is at least 50% charged before you perform any system upgrade, self-test, or maintenance procedure.



## CAUTION

Medical electrical equipment requires special precautions regarding electromagnetic compatibility (EMC) and must be installed and operated according to the instructions in this manual. For more information, see the “Electromagnetic Compatibility” section.

This device can radiate radio frequency energy and is very unlikely to cause harmful interference with other devices in the vicinity. There is no guarantee that interference will not occur in a particular installation. Evidence of interference may include degradation of performance in this device or other devices when operated simultaneously. To correct interference, use the following measures:

- Turn devices on and off in the vicinity to determine the source of interference.
- Reorient or relocate this device or other devices.
- Increase the separation between devices.
- Connect the device to an outlet on a circuit different than the other device(s).
- Eliminate or reduce EMI with technical solutions (such as shielding).
- Purchase medical devices that comply with the IEC 60601-1-2 standard.
- Be aware that portable and mobile radio frequency communications equipment (cellular phones, etc.) may affect medical electrical equipment; take appropriate precautions during operation.



## CAUTION

Failure to follow these instructions may cause device damage not covered by the warranty:

- Do not immerse the instrument in cleaning or disinfectant solution or other liquids.
- Do not subject any part of the instrument to steam, ethylene oxide, radiation, or similar methods of sterilization or autoclaving.
- Do not use metal or abrasive brushes. These may scratch the instrument, causing permanent device damage.

# INTRODUCTION

---

## SYSTEM OVERVIEW

BladderScan Prime Plus is a 3D ultrasound system that noninvasively measures bladder volume. The core components of the system are a console with a touchscreen display, a probe containing the ultrasound transducer, and a battery charger with rechargeable lithium-ion batteries. There are several accessories and configuration options available for the system, including a mobile cart, a printer, and external memory solutions. For more information, see [Components & Accessories](#) on page 9.

*Figure 1. BladderScan Prime Plus System*



The system includes an onboard tutorial as well as integrated help screens. The console features a variety of customizable settings and a saved scans function that allows you to recall, print, or transfer saved exams.

The console also features an optional live imaging pre-scan mode that enables you to locate the bladder by displaying a B-mode view of the abdomen in real time, prior to completing the volume measurement scan.



# COMPONENTS & ACCESSORIES

Table 1. Included System Components & Accessories

INCLUDED SYSTEM COMPONENTS & ACCESSORIES		
		
Console		Probe
		
Battery	Console base	Battery charger
		
Power adapter	In-service USB flash drive	Media storage USB flash drive
		
Power cord <i>Note: Plug may vary by region</i>		Port cover

Table 2. Optional System Components & Accessories



Additionally, quick reference materials and ultrasound gel may be available for order in your region. For more information, contact Verathon Customer Care or your local representative or visit [verathon.com/service-and-support](http://verathon.com/service-and-support).

# SYSTEM FEATURES

## CONSOLE FEATURES



Please read the [Warnings & Cautions](#) section before using the system.

The console's primary feature is a touchscreen display that allows you to perform scans, manage scan results, and customize settings. It provides controls for adjusting brightness and volume and activating the system or putting it in standby mode. A rechargeable battery is inserted into one side of the console, and the other side features a selection of ports for connecting system components and accessories such as external, removable media storage devices. You may also customize your console by adding an optional printer, attaching the console base, or mounting the console on a mobile cart.

Figure 2. Console Features

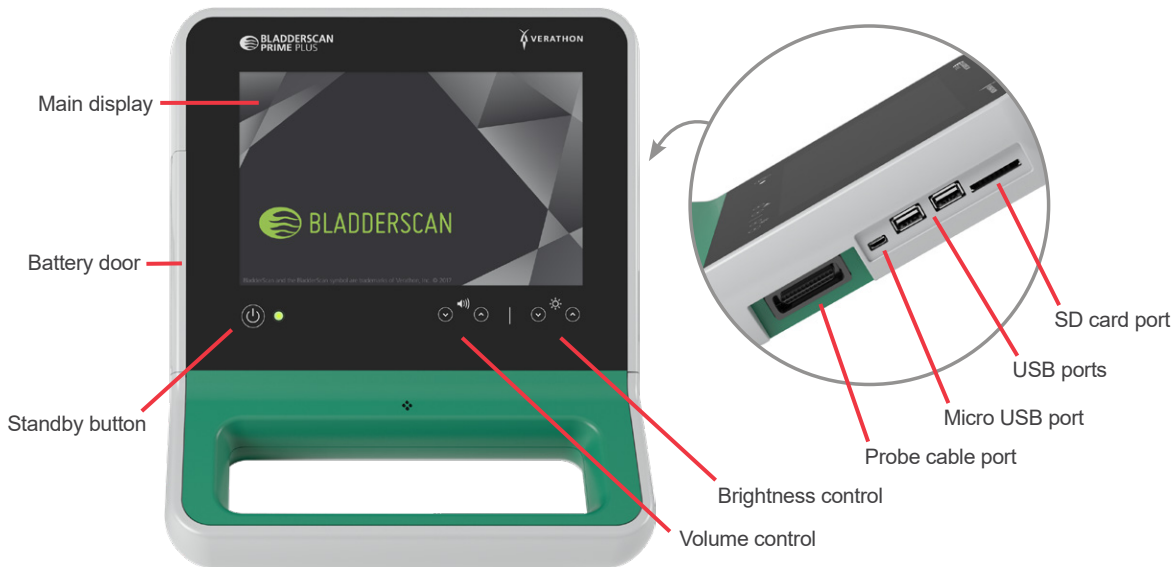

Table 3. Console Features

PART NAME	PURPOSE
Main display	Features touchscreen controls of the system user interface.
Battery door	Opens to access and replace the rechargeable battery.
Standby button	Activates the unit or puts it in standby mode. When the unit is active, an LED next to the Standby button is illuminated.
Volume control	Adjusts volume up or down.
Brightness control	Adjusts the main display to be brighter or dimmer.
Probe cable port	Connects the system probe and console.
USB ports	Provides connection for external, removable storage media.
Micro USB port	Not functional in this version of BladderScan Prime Plus.
SD card port	Provides connection for external, removable storage media.

## PROBE FEATURES

The probe contacts the patient and transmits and receives ultrasound waves, automatically moving its internal transducer to scan twelve planes in order to produce a three-dimensional image of the bladder. The probe is attached to the console by a cable. After a scan, the probe displays bladder volume and aiming.

Figure 3. Probe Features



Table 4. Probe Features

PART NAME	PURPOSE
Probe button	Starts aiming or scanning when pressed.
Probe display	Displays ready, in progress, and scan results information.
Probe cable	Connects the probe to the console.
Probe dome	Contacts the patient's abdomen and transmits ultrasound.

## BATTERY & BATTERY CHARGER FEATURES

The system is powered by a lithium-ion battery. The battery charger provided with the system can charge one or two batteries. Removing a discharged battery from the system and replacing it with a fresh battery does not erase any saved exams or system settings.

To provide power to the batteries, the battery charger must be connected to a wall outlet using the power adapter and power cord provided. Use only the battery charger provided with the system. Any other battery charger may damage the battery. The battery charger automatically detects whether a lithium-ion battery is being charged. To prevent incorrect connections, the battery is shaped so that it can only be inserted into the console or the battery charger in the correct orientation.

Each battery features a test button that allows you to check the charge level of the battery without inserting it into the console. If you press the **Test** button on the back of the battery, the display next to the test button illuminates to display the approximate charge level: 25%, 50%, 75%, or 100%. Two replaceable batteries ensure the instrument is always available (provided the spare battery is charging when not in use).



















## SYSTEM ICONS

### CONSOLE TOUCHSCREEN ICONS

The console touchscreen displays the interface that controls the system. The following icons may appear on the screen, and you may tap them to complete the function associated with the icon.

Table 5. Touchscreen Icons







ICON	FUNCTION
	<b>Saved Scans</b> —View all scans that are saved to the console.
	<b>Settings</b> —Open the Settings screen.
	<b>Scan</b> —Start scanning the patient.
	<b>B-Mode</b> —View the ultrasound image as pairs of two-dimensional, orthogonal planes from the three-dimensional scan. The contours of detected features are overlaid on the image. <i>Note: You may disable the display of the detected contours. For more information, see <a href="#">Configure Exam Settings</a> on page 28.</i>

ICON	FUNCTION
	<p><b>C-Mode</b>—View the ultrasound image as a cross-section view of the three-dimensional scan. The C-Mode image consists of a circular region with a crosshair overlay. This image displays the bladder shape and, if detected, the shadow of the pubic bone.</p> <p>The probe displays scan results in C-mode. The console displays scan results in C-mode by default, and B-mode may be selected for any scan.</p>
	<p><b>Clear</b>—On the Results screen, clear all scan data within the current exam, but maintain patient information.</p>
	<p><b>Delete</b>—On the Saved Scans screens, delete a saved exam that is currently being viewed.</p>
	<p><b>Delete</b>—On the Saved Scans screens, delete a saved exam from the exam list.</p>
	<p><b>Help</b>—Start the onboard tutorial or display screen-sensitive help text.</p>
	<p><b>Print</b>—Print the scan, self-test, or savings calculation results.</p> <p><i>Note: This function is only available if you have attached the optional printer.</i></p>
	<p><b>Done</b>—On the Results screen, save the scan result with the largest volume and return to the Home screen.</p>
	<p><b>Export Exams</b>—On the Saved Scans screen, move exams from the system's internal storage to an external USB drive or SD card. This option is only available if external storage is connected.</p>
	<p><b>Configure Savings</b>—Customize the values for calculating the cost savings that result from scanning rather than catheterizing patients.</p>
	<p><b>Back</b>—Return to the previous screen or the Home screen.</p>
	<p><b>Cancel</b>—On the Results screen, cancel the scan without saving and return to the Home screen.</p>
	<p><b>Next</b>—Advance to the next screen.</p>
	<p><b>Play</b>—On the onboard tutorial, play the tutorial.</p>
	<p><b>Pause</b>—On the onboard tutorial, pause the tutorial.</p>
	<p><b>Previous</b>—On the onboard tutorial, move to the previous frame of the tutorial.</p>
	<p><b>Next</b>—On the onboard tutorial, move to the next frame of the tutorial.</p>

## CONSOLE BATTERY LEVEL ICONS

The battery level icon is displayed in the status bar at the top of the touchscreen. The icon and the percentage value next to the icon indicate the remaining battery power. For information about charging the battery, see the procedure [Charge the Battery](#) on page 17.



Table 6. Battery Level Icon

ICON	FUNCTION
	Battery approximately 100% charged.
	Battery approximately 80% charged.
	Battery approximately 60% charged.
	Battery approximately 40% charged.
	Battery approximately 20% charged.
	Battery discharged. Replace or recharge battery immediately.

## PROBE ICONS

The following icons may appear on the probe display.

Table 7. Probe Icons

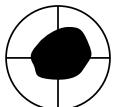
ICON	FUNCTION
	<b>Patient Orientation Mode</b> —When the system is ready to scan, the probe displays an icon indicating the currently selected patient orientation. The displayed patient orientation icon on the probe is updated when you change the patient orientation on the console Home screen.
	<b>Scan in Progress Mode</b> —When a scan is in progress, the probe displays the BladderScan logo.
	<b>Results Mode</b> —After a scan has been completed, the probe displays the position of the bladder in relation to the probe and the value of the largest volume acquired in the current exam.  <i>Note: This display can be used to help position the probe. If the bladder is off-center on the probe display, move the probe in the direction of the bladder and scan again.</i>

# SETTING UP

---

To help you get started, the following topics explain how to assemble the system:

1. [Perform the Initial Inspection](#)
2. [Charge the Battery](#)
3. [Attach the Probe to the Console](#)
4. [Attach the Console Base or Printer](#)
5. [Attach the System to the Mobile Cart \(Optional\)](#)
6. [Install the Port Cover \(Optional\)](#)
7. [Insert a Battery](#)

Once the system is assembled, you can configure user settings and add custom information:

8. [Configure General Settings](#)
9. [Configure Exam Settings](#)
10. [Customize Cost Savings Calculations](#)
11. [Configure Printed and PDF Report Settings](#)
12. [Configure a PIN for Saved Scans](#)
13. [Configure a PIN for System Settings](#)

## ASSEMBLING THE INSTRUMENT

---

### PROCEDURE 1. PERFORM THE INITIAL INSPECTION

---

When you receive the system, Verathon recommends that an operator familiar with the instrument perform a full visual inspection of the system for any obvious physical damage that may have occurred during shipment.

1. Carefully open the top of the shipping box. Do not insert anything sharp through the box.
2. Remove the contents and verify that you have received the appropriate components for your system.
3. Inspect the components for damage.
4. If any of the components are missing or damaged, notify the carrier and Verathon Customer Care or your local representative.



## PROCEDURE 2. CHARGE THE BATTERY



Please read the [Warnings & Cautions](#) section before performing the following task.

Two lithium-ion batteries are included with the system. It is recommended that you charge one battery while the other is in use. Before using the system for the first time, you must fully charge the batteries.

When the system is in standby mode, it draws some power from the battery. If you do not plan to use the instrument, remove the battery to prevent it from discharging. When batteries are not in use, they should be stored in the battery charger so they remain fully charged.

1. Before each use, inspect the battery charger, batteries, power adapter, and power cord for damage. If a component is damaged, do not use it. Contact Verathon Customer Care or your local representative.
2. Connect the power adapter to the power cord.



3. Connect the power adapter to the battery charger.



4. Plug the power supply into a standard wall outlet. Ensure the power cord can be easily disconnected.

5. Insert one or two batteries into the recesses in the battery charger. It is recommended that you charge both batteries when setting up the system for the first time.



6. Allow the battery to fully charge. The indicator lights on the battery charger indicate the status:
  - Green solid—Battery is fully charged
  - Green flashing—Battery is fast-charging
  - Yellow solid—Battery charging is suspended or in standby mode
  - Red—Charging error. Contact Verathon Customer Care or your local representative.
  - Off—No battery detected

---

### PROCEDURE 3. ATTACH THE PROBE TO THE CONSOLE

---

Once the probe is attached to the console, it can remain attached between uses.

1. Locate the port on the side of the console.



2. Align the probe cable connector with the port on the console.
3. Gently push the connector into the port, until the connector clicks into place and is secure.



*Note: Before you connect or disconnect the probe from the console, ensure the console is turned off by removing the battery from the instrument. To disconnect the probe, squeeze the connector brackets and then pull the probe cable connector out of the port. Do not pull on the cable.*

---

## PROCEDURE 4. ATTACH THE CONSOLE BASE OR PRINTER

---

A console base is included with the system. An optional printer is also available for order. Verathon recommends that you attach either the console base or the printer, as it provides support for the console and protection to the contacts on the back of the console. This procedure documents how to attach either the console base or printer.

### OPTION 1. ATTACH THE CONSOLE BASE

---

1. Ensure the console is turned off by removing the battery from the instrument.
2. Place the console on a flat stable surface, display side down.
3. If you will be mounting the system on a cart, skip to [Attach the System to the Mobile Cart \(Optional\)](#) on page 21. Otherwise, place the console base in the recess as shown.
4. Using a screwdriver with a Phillips bit, attach the base to the console.



### OPTION 2. ATTACH THE PRINTER

---

1. Ensure the console is turned off by removing the battery from the instrument.
2. Place the console on a flat stable surface, display side down.
3. Inspect the electrical contacts on the console.
4. If you will be mounting the system on a cart, skip to [Attach the System to the Mobile Cart \(Optional\)](#) on page 21. Otherwise, place the printer in the recess as shown.
5. Using a screwdriver with a Phillips bit, attach the printer to the console.



## PROCEDURE 5. ATTACH THE SYSTEM TO THE MOBILE CART (OPTIONAL)

The system is portable and can be carried or attached to a mobile cart. Installing the system on the optional mobile cart will allow you to move the system, along with related accessories, to the patient examining area or bedside, as necessary.

This procedure provides instructions for mounting the system on the mobile cart. You should have either the console base or the printer available before you begin this procedure and install it along with the mounting bracket. For purposes of clarity, this procedure shows the console with its base.

*Note: Attaching the mounting bracket requires different hardware (screws and spacers) depending on which attachment you install with it. Refer to the quick start sheet accompanying the bracket for information about which set of hardware you should use.*

1. Assemble the mobile cart according to the instructions included with the cart.
2. On the mobile stand mount, ensure that the locking pin and quick-release lever are in the unlocked (horizontal) position.

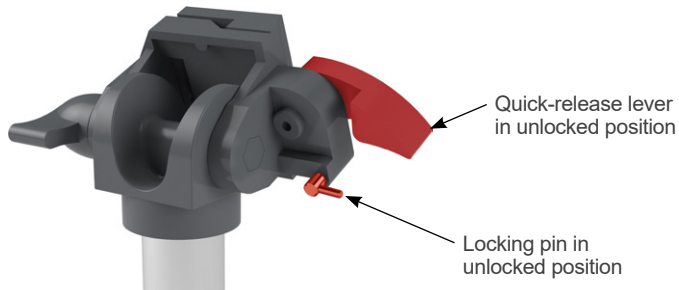

3. If you are installing a printer, remove its mounting screws. On older printers, it may be necessary to use a Phillips screwdriver and backward pressure to remove the screws from the printer.



4. Place the appropriate attachment (console base or printer) into the recess on the console.

Figure 4. Prime Mobile Cart



5. Secure the attachment and the mounting bracket to the back panel of the console, as shown in the following figure.

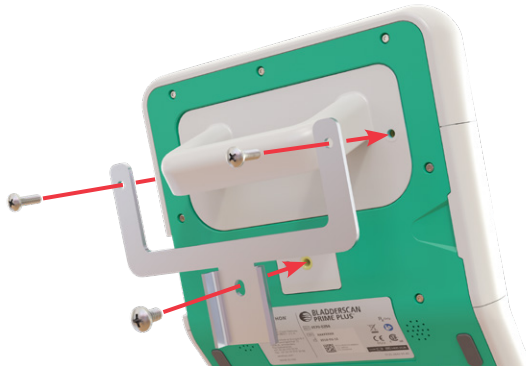

6. Seat the bottom leg of the bracket on the quick-release mount. When properly situated, the console sits securely on the mount, and the quick-release lever automatically snaps into the locked (down) position.
7. Ensure that the quick-release lever is fully in the locked (down) position. This secures the console in place.

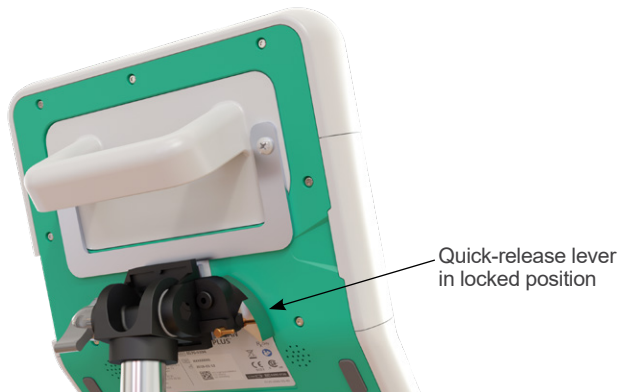

8. Adjust the locking pin to the locked (down) position. This secures the quick-release lever in the locked position.



## ADJUST THE MONITOR ANGLE

Before you start using the console, adjust the angle for optimal viewing. The ideal angle minimizes glare and maximizes visibility.

9. Turn the angle adjustment knob counterclockwise.

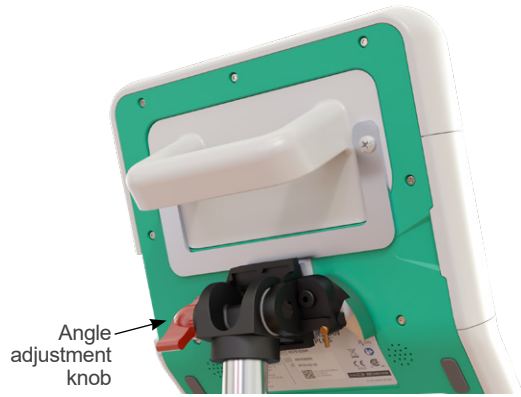

10. Tilt the console to the desired angle.
11. Turn the angle adjustment knob clockwise. This secures the console at the desired angle.

## PROCEDURE 6. INSTALL THE PORT COVER (OPTIONAL)

The console features a series of ports that allow you to connect external media storage devices, such as SD cards or USB flash drives. If these ports will not be used at your facility, you can hide them by attaching the port cover included with your system. This port cover adheres securely to the console. Once the port cover is installed, you will not be able to save exam results to external media.

Please note that the port cover is not intended to be removed and then reapplied. Once the port cover has been applied, it is semi-permanently attached.

Figure 5. Console Ports



1. Remove the battery from the console.
2. If an external media storage device, such as a USB flash drive or SD card, is inserted in the console, remove it.
3. Clean the console according to the instructions in [Clean & Disinfect the System](#) on page 46. A clean surface helps ensure proper adhesion.
4. Allow the console surfaces to dry completely.
5. On the port cover, remove the backing from the two adhesive pads.

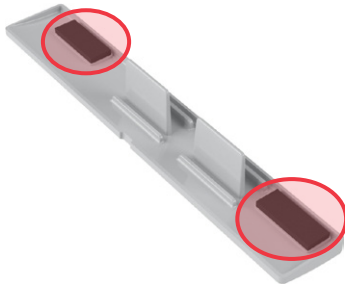

6. Align the port cover with the ports in the console.
7. Insert the port cover into the console, and then press firmly for 30 seconds. This helps ensure good adhesion.

The port cover is now securely attached to the console. If the port cover needs to be removed and then reinstalled, the remaining adhesive may be insufficient to properly reattach the port cover. To order a replacement port cover, please contact Verathon Customer Care or your local representative.



## PROCEDURE 7. INSERT A BATTERY

1. Open the battery well door on the console. Pull the door out from the console at the bottom edge; the hinge is on the screen side of the unit.
2. If a battery is already in the console, remove it by pushing the tab down and pulling the battery out.

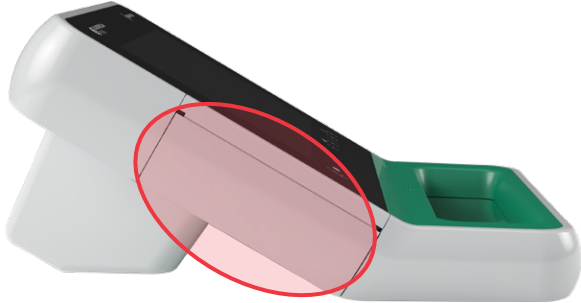

3. Slide a charged battery into the battery well, and then push gently until the battery clicks into place.

*Note: The battery is designed to prevent incorrect installation. If the battery does not slide into the battery well easily, remove the battery, reorient it, and try again. Do not attempt to force the battery into position.*

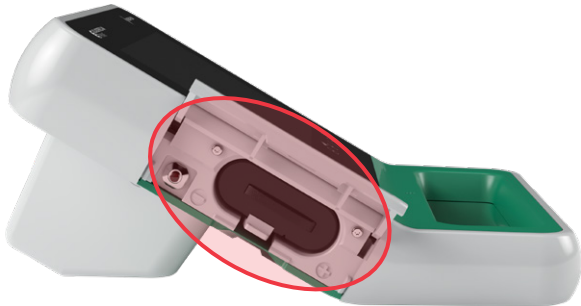

4. Close the battery well door. The system begins startup.
5. Allow the instrument to complete startup. When the system is ready for use, the Home screen appears.
6. If you are completing the initial setup, it is recommended that you continue to the following section in order to customize the system settings.

If you do not want to use the system immediately, press the **Standby** button . When prompted, confirm that you want the system to enter standby mode, and then wait for it to do so.

# CONFIGURING SETTINGS

The system is configured with default settings that are appropriate for many users. This section contains instructions for modifying the defaults for your facility's needs.

## PROCEDURE 1. CONFIGURE GENERAL SETTINGS

This procedure helps you configure your regional and facility preferences, such as the name of your facility, the language in which your system operates, and your formatting preferences for the time, date, currency, and numbers.

1. On the Home screen, tap **Settings**. The Settings screen opens to the General tab.

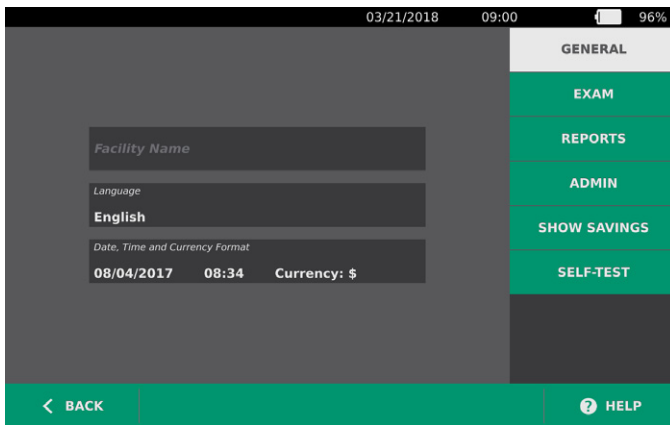

2. On the General tab, tap **Facility Name**, use the virtual keyboard to type a name, and then tap **Enter**. This name is displayed on the status bar at the top of each screen.

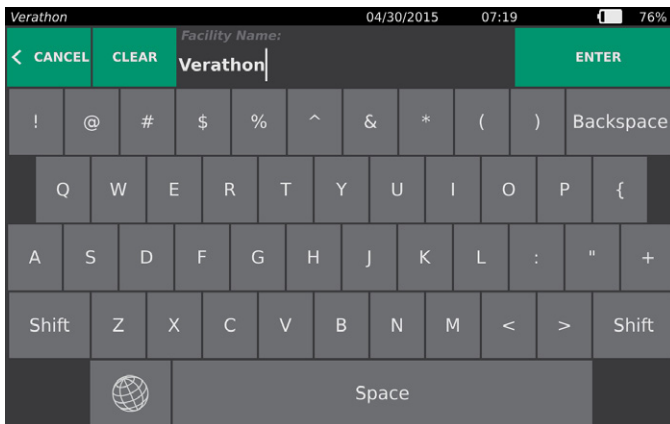

3. If you would like to change the language in which the system operates and exams are saved, tap **Language**, and then select an available option. The language updates immediately.

4. Tap **Date, Time and Currency Format**. The Date, Time and Currency screen appears.

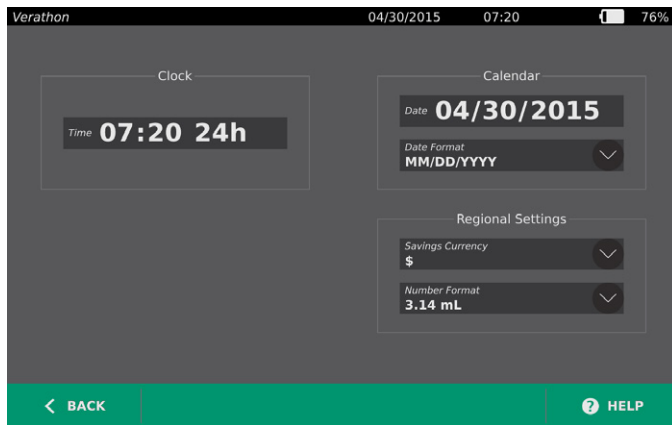

5. In the **Time** field, tap the hour or minutes, vertically swipe to view a value, and then tap the value to select it.
6. In the **Time** field, tap the time format. The time format scrolls through AM, PM, and 24-hour displays. If you select a new time format, the hours and minutes values are updated as necessary.
7. In the **Date** field, tap the month, day or year, vertically swipe to view a value, and then tap the value to select it. Repeat as needed to set the desired month, day, and year.
8. In the **Date Format** field, tap the arrow, and then select the month, day, and year display order. The **Date** field immediately updates to display the selected format.
9. In the **Savings Currency** field, tap the arrow and then select the desired currency. This unit is used when displaying savings as a result of using the BladderScan instrument instead of catheterization.
10. In the **Number Format** field, tap the arrow to select the display format for numeric fields.
11. When you are finished configuring the Date, Time, and Currency settings, tap **Back**, then **Admin**.

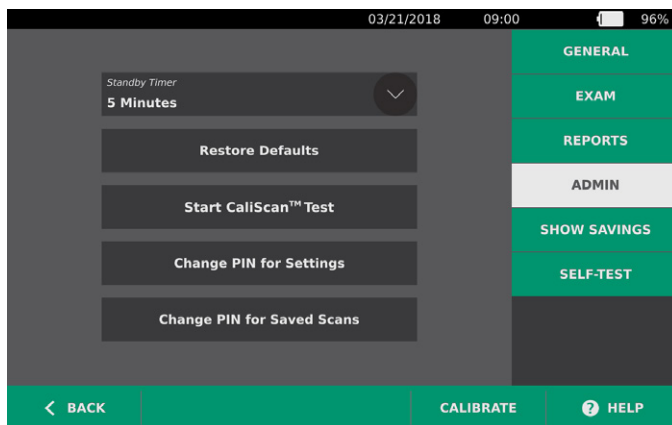

12. On the Admin tab, in the **Standby Timer** field, tap the arrow and then select the number of minutes before the instrument goes into standby mode.
13. When you are finished configuring settings, tap **Back**. This saves your settings and returns the console to the Home screen.

## PROCEDURE 2. CONFIGURE EXAM SETTINGS

You may configure the following exam settings:

- Display of B-Mode images
- Live B-mode aiming
- A time-out period for the live B-mode aiming feature
- Bladder outline on B-mode images

1. On the Home screen, tap **Settings**, and then tap **Exam**.
2. If a keypad appears, key in the PIN for Settings, and then tap **Enter**.
3. On the Exam tab, tap the field to update, and then if applicable, select or type new values:
  - **Enable B-Mode Plane Images**—Allows the display of B-mode images in saved exams and printed reports.
  - **Enable Live B-Mode Aiming**—Activates a real-time, B-mode ultrasound preview of the bladder before the scan in order to provide aiming assistance.
  - **Inactivity Timeout**—Defines the amount of time live B-mode aiming is active. Once the timeout period has been reached, the system returns to the Home screen. This setting is only visible if live B-mode aiming is enabled.
  - **Show Bladder Outline**—On B-mode images, displays a green outline around the detected edges of the bladder. This feature is known as *BladderTraq*.
  - **Assign Patient ID Automatically**—Automatically generates a new patient ID for each exam. You can replace this ID at the beginning of an exam, as described in the section [Input Patient Information or Operator ID \(Optional\)](#) on page 34.

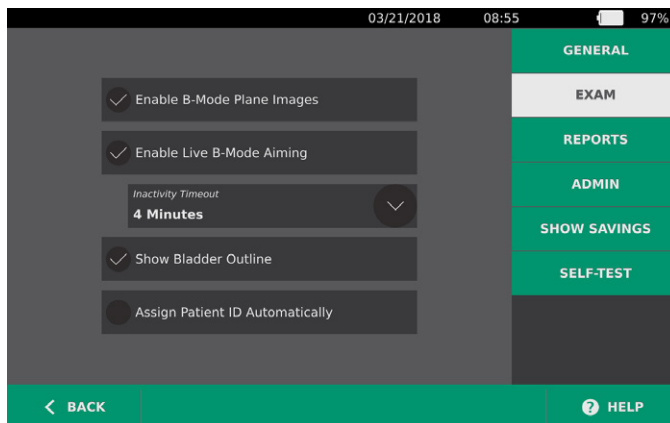

4. When you are done, tap **Back**. This saves your settings and returns the console to the Home screen.

## PROCEDURE 3. CUSTOMIZE COST SAVINGS CALCULATIONS

The system provides default values for calculating the cost savings that result from scanning rather than catheterizing patients. The default settings can be customized to reflect the rates and costs at your facility. To change the currency used for cost savings calculations, see [Configure General Settings](#) on page 26.

Total cost savings from using the system are based on the following formula:

$$\text{Total cost savings} = (\text{Catheterizations avoided} \times \text{Catheterization costs}) + (\text{UTIs avoided} \times \text{UTI costs})$$

1. On the Home screen, tap **Settings**, and then tap **Show Savings**.
2. On the Show Savings tab, tap **Configure Savings**.

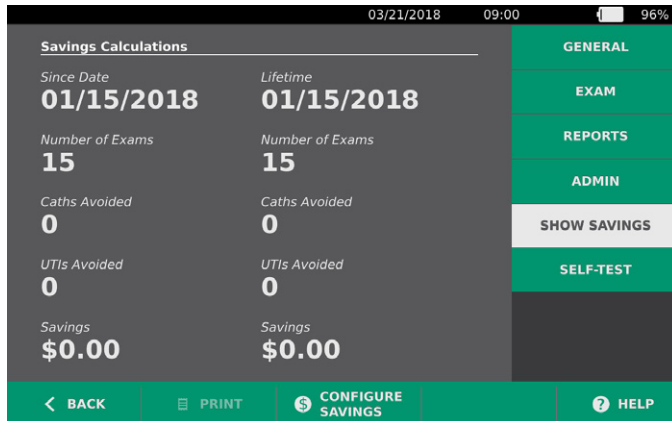

3. On the Configure Savings screen, tap a field to update, and then enter new values. Numeric fields accept decimal input but round to the nearest whole number.
  - **UTI Rate**—Select the rate of urinary tract infections (UTIs) resulting from catheterizations.
  - **UTI Cost**—Select the cost per UTI at your facility.
  - **Catheterization Cost**—Select the cost per catheterization procedure.
  - **Catheterization Volume**—Select the volume threshold for catheterization. Scans below the volume threshold are not used in cost savings calculations.

*Note: The Reset Calculations button restarts savings calculations as of the date this button is selected. Tapping this button is not required to update savings values.*

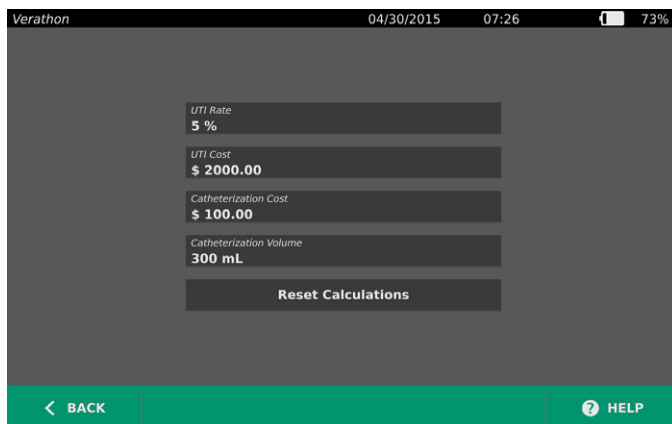

4. When you are finished, tap **Back** twice. This saves your settings and returns the console to the Home screen.

## PROCEDURE 4. CONFIGURE PRINTED AND PDF REPORT SETTINGS

If a printer is attached to the console, you can print scan results. Reports are printed vertically, like a receipt. Scan reports are made up of a number of sections. Some of the sections are optional.

You can customize which sections and B-mode images are included in reports, regardless of whether they are printed or exported in PDF format.

1. On the Home screen, tap **Settings**, and then tap **Reports**.
2. If a keypad appears, key in the PIN for Settings, and then tap **Enter**.

The Settings screen opens to the Reports tab.

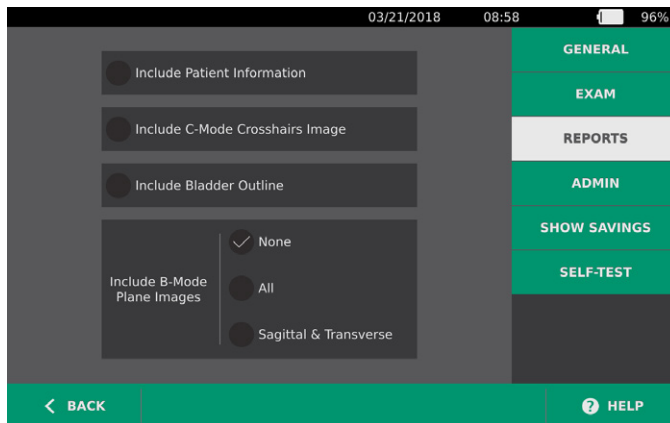

3. Tap the information to include in reports. If a check mark is displayed to the left of the information description, the following information is printed:
  - **Include Patient Information**—Select to include patient data, such as patient ID or date of birth.
  - **Include C-Mode Crosshairs Image**—Select to include the coronal view image computed by the system. The aiming circle and crosshairs are printed as black lines.
  - **Include Bladder Outline**—Select to add contours to the B-mode image.
  - **Include B-Mode Plane Images**—Select one of the following groups of images to include in printed and exported reports:
    - **None**—Select to include no B-mode image planes.
    - **All**—Select to include all 12 B-mode image planes.
    - **Sagittal & Transverse**—Select to include the two primary B-mode image planes.
4. When you are finished configuring the printed report settings, tap **Back**. This saves your settings and returns the console to the Home screen.

## PROCEDURE 5. CONFIGURE A PIN FOR SAVED SCANS

If it is necessary to restrict access to saved patient and exam information, you can create a PIN to protect that information. After you create the PIN, the system does not display saved exams unless the PIN is entered. Deleting the PIN deactivates this requirement.

If you need to change the PIN, you must enter the existing PIN before you create the new one.

1. At the Home screen, tap **Settings**.
2. At the Settings screen, tap the **Admin** tab.

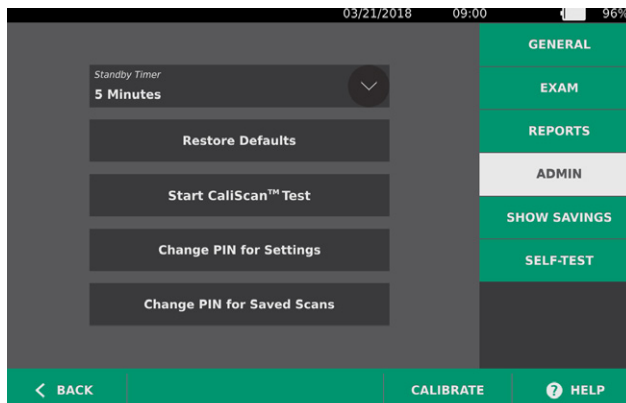

3. On the Admin tab, tap **Change PIN for Saved Scans**.
4. If the **Enter Current Saved Scans PIN** box appears, tap it. Using the keypad, key in the PIN currently required for access to saved scans on the system, and then tap **Enter**.

*Note: If you want to remove the digits that have already been entered, tap **Clear**.*

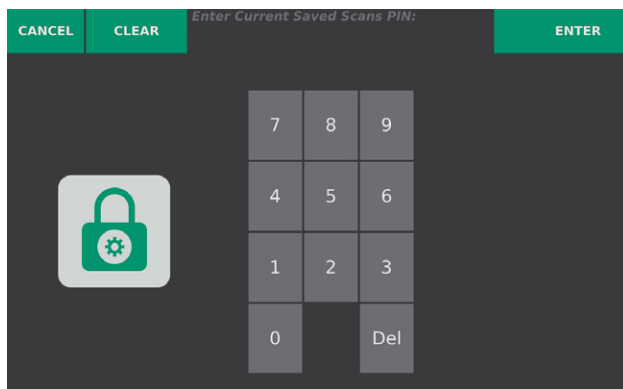

5. Tap the **Enter New Saved Scans PIN** box. Using the keypad, key in the new 4-digit PIN required for access to saved scans on the system, and then tap **Enter**.

Alternatively, if you want to deactivate the PIN for Saved Scans, clear any entered digits, and then tap **Enter**.

6. Tap the **Confirm New Saved Scans PIN** box, and then enter the same code you entered in the previous step.
7. Tap **Save PIN for Saved Scans**.

## PROCEDURE 6. CONFIGURE A PIN FOR SYSTEM SETTINGS

If it is necessary to ensure that system configuration settings are consistent throughout your organization, you can create a PIN to restrict people from changing the settings on the Exam and Reports tabs or resetting the system to factory defaults. Deleting the PIN for Settings makes these items available to anyone.

If you need to change the PIN for Settings, you must enter the existing PIN before you create the new one. If you have forgotten the existing PIN, contact Verathon Customer Care for assistance in clearing it.

1. At the Home screen, tap **Settings**.
2. At the Settings screen, tap the **Admin** tab.

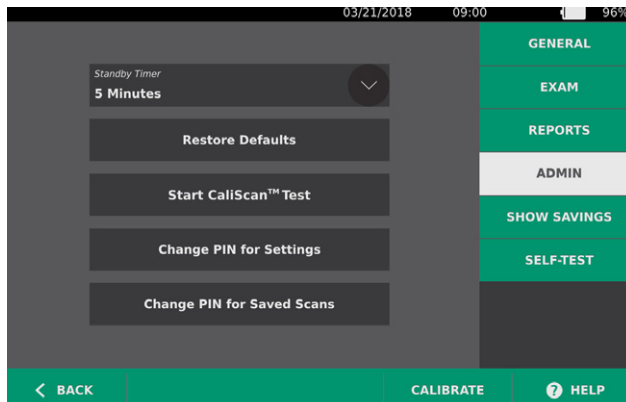

3. On the Admin tab, tap **Change PIN for Settings**.
4. If the **Enter Current Settings PIN** box appears, tap it. Otherwise, if you are entering a PIN for Settings for the first time, skip to Step 6.
5. Using the keypad, key in the PIN currently required for access to system settings, and then tap **Enter**.

*Note: If you want to remove the digits that have already been entered, tap **Clear**.*

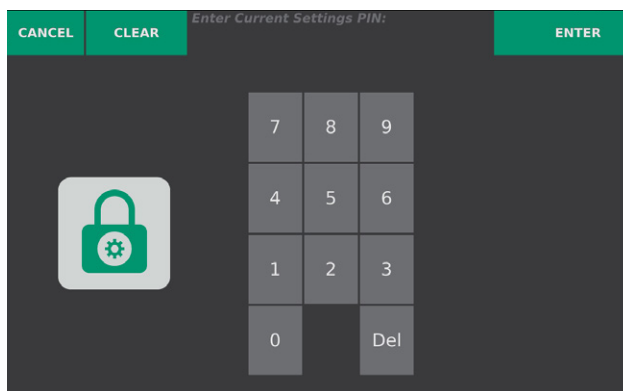

6. Tap the **Enter New Settings PIN** box. Using the keypad, key in the new 4-digit PIN required for access to system settings, and then tap **Enter**.  
Alternatively, if you want to deactivate the PIN for Settings, clear any entered digits, and then tap **Enter**.
7. Tap the **Confirm New Settings PIN** box, and then enter the same code you entered in the previous step.
8. Tap **Save PIN for Settings**.



# USING THE INSTRUMENT



Please read the [Warnings & Cautions](#) section before performing the following tasks.

## MEASURING BLADDER VOLUME

### PROCEDURE 1. PREPARE FOR THE EXAM

Ensure you are familiar with the instrument touchscreens and probe displays. For more information about the components and user interface, see the [Introduction](#) chapter on page 8.

1. If a charged battery is inserted in the console and the screen is blank, then the instrument is in standby mode. Press the **Standby** button (⏻).

If the system has a discharged battery or a battery is not inserted, insert a charged battery.

2. Allow the instrument to start. When the instrument is fully started, the Home screen appears as shown in the following figure.

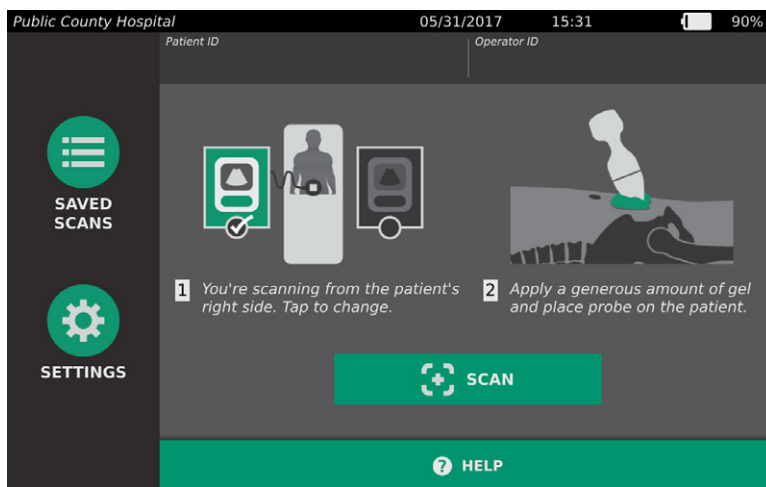

3. Check the instrument battery icon to ensure the battery has sufficient power.

*Note: If the battery icon is 20% full or less, replace the battery with a fully charged battery before proceeding.*

4. Ensure that the instrument has been properly cleaned according to the instructions in the [Cleaning & Disinfecting](#) chapter on page 44.

---

## PROCEDURE 2. INPUT PATIENT INFORMATION OR OPERATOR ID (OPTIONAL)

---

The system lets you enter the following patient information, which will be saved with the exam and can be printed on the exam report:

- Patient ID
- First name
- Last name
- Sex
- Date of birth

The Operator ID may also be updated at this time. The Patient ID and Operator ID fields are displayed at the top of many screens. You can tap the field and update Patient or Operator ID information whenever the field is visible.

1. On the Home screen, tap **Patient ID**. The Patient and Operator ID screen appears.

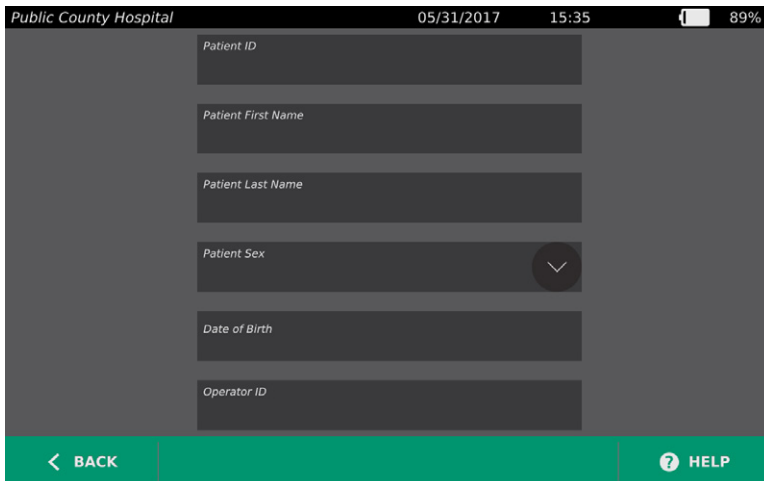

2. On the Patient Data screen, tap **Patient ID**, use the virtual keyboard to type a value, and then tap **Enter**.
3. Tap **Patient First Name**, and then enter the patient's first name.
4. Tap **Patient Last Name**, and then enter the patient's last name.
5. Tap **Patient Sex**, and then tap the sex for the patient.
6. Tap the **Date of Birth** field, vertically swipe to change a value, and then tap the new value to select it. Repeat as needed to set the desired month, day, and year.
7. Tap **Operator ID**, and then use the virtual keyboard to enter or update the operator's identifying information.
8. When you are finished inputting the patient's information, tap **Back**.

## PROCEDURE 3. MEASURE BLADDER VOLUME

The system has several features designed to help with locating and identifying the bladder. These features may be enabled or disabled according to the instructions in [Configure Exam Settings](#) on page 28:

- **Live B-Mode Aiming**—The system displays a real-time B-mode ultrasound view of the patient's abdomen, allowing you to aim the probe and locate the bladder prior to scanning.
- **Bladder Outline (BladderTraq)**—In B-mode views, the system highlights the detected edges of the bladder by outlining the bladder area in green.

1. On the Home screen, select whether you are standing on the patient's left or right side.

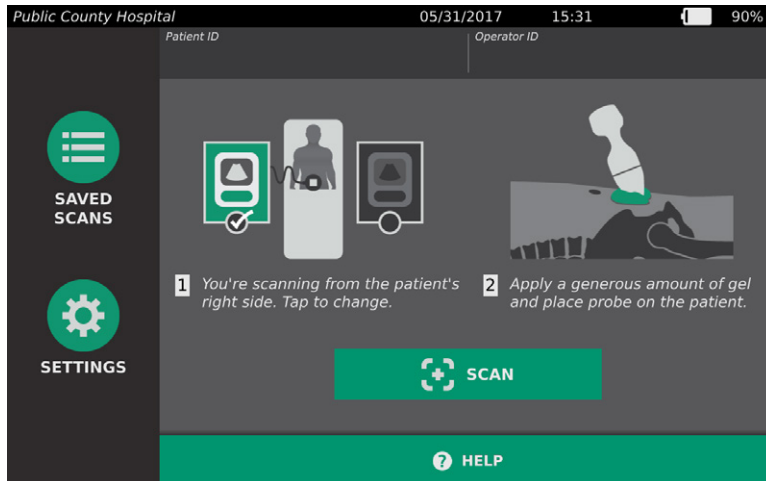

2. With the patient lying in a supine position and with the abdominal muscles relaxed, palpate the patient's pubic bone.

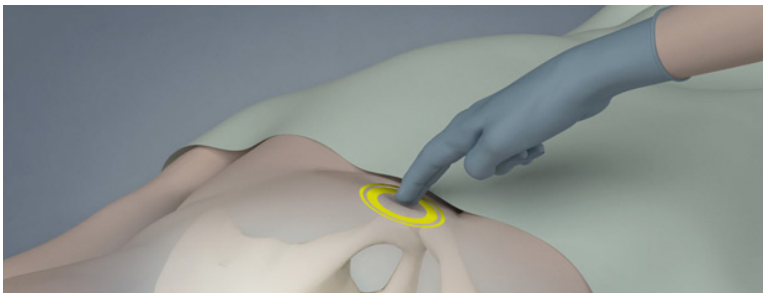

3. Place an ample quantity of ultrasound gel, with as few air bubbles as possible, midline on the patient's abdomen, approximately 3 cm (1 inch) above the pubic bone.

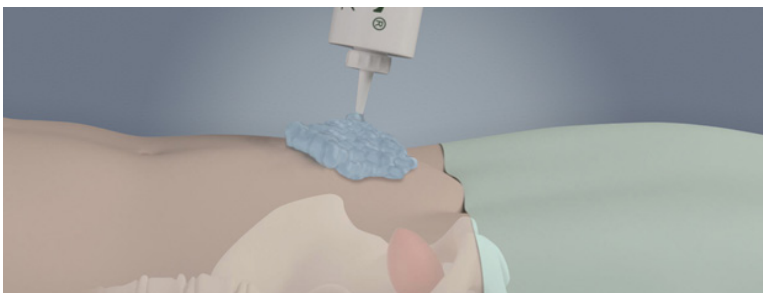

4. Hold the probe by grasping it with the probe cable running up your wrist and forearm.

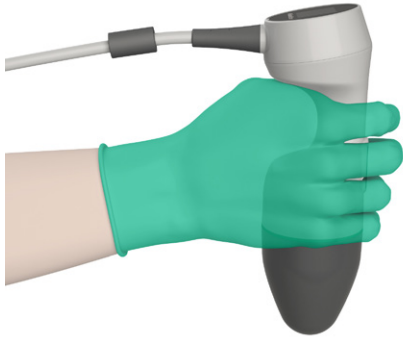

5. Gently press the probe onto the lower abdomen through the gel. The probe cable should be oriented at 90 degrees to the sagittal plane of the patient, and the head of the image on the probe's LCD screen should be pointing toward the patient's head.

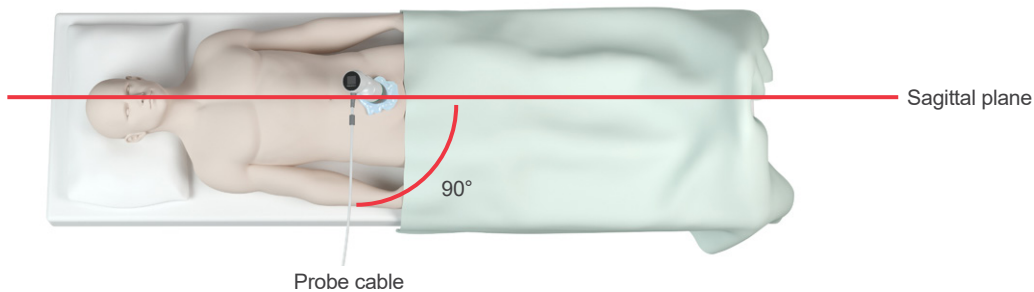

6. If you are scanning an obese patient, lift as much abdominal adipose tissue out of the way of the instrument as possible. Apply more pressure to the probe in order to reduce the amount of adipose tissue through which the ultrasound must pass.
7. Ensure that there are no air gaps between the probe and the patient's skin and that you are applying enough pressure to maintain adequate skin contact until the scan is complete. If necessary, add more gel to ensure proper contact.
8. Press the probe button or tap **Scan** on the Home screen.
  - If live B-mode aiming is enabled, continue to Step 9.
  - If live B-mode aiming is disabled, hold the probe steady while the scan is in process, and then continue to the next procedure, [Review Exam Results](#).

9. If live B-mode aiming is enabled, a real-time B-mode ultrasound image appears on the console screen. Target the bladder by doing the following:
  - Angle the probe slowly from the patient's left to right until the dark (bladder) area is centered on the vertical green line on the aiming screen.
  - Once the bladder is centered, angle the probe slightly up or down the patient's midline to obtain the largest possible dark area.

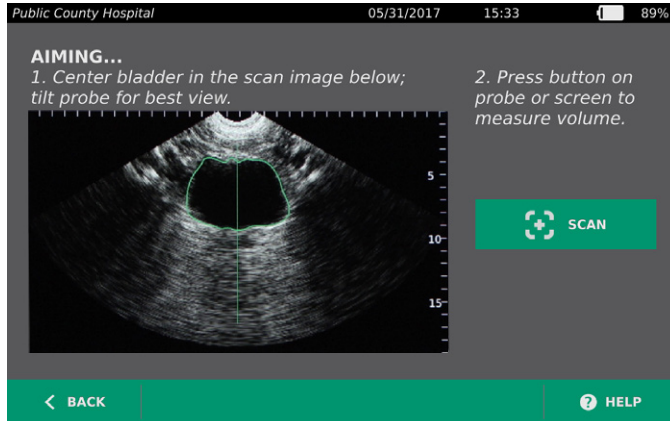

10. Once you are finished aiming the probe, press the probe button or tap **Scan** on the screen. The scanning process begins.
11. Hold the probe steady while the scan is in process. When you hear the end-scan tone, the scan is complete. Continue to the next procedure, [Review Exam Results](#).

---

## PROCEDURE 4. REVIEW EXAM RESULTS

This section describes the procedures that can occur after the scan. Perform the procedures that are applicable for your installation.

### CONFIRM OR ADJUST AIM

Aiming technique can have an impact on the bladder measurement result. When the bladder is partially outside the ultrasound field of view or obstructed by the pubic bone at certain scanning angles, then the actual bladder volume may exceed the displayed result. To help ensure the highest degree of accuracy, the system has several features to assist with aiming technique and confirmation.

- When the Results screen appears, check whether a yellow greater than (>) symbol appears next to the recorded volume and the bladder is shown in yellow. If this occurs, a portion of the bladder was outside the ultrasound field of view, and the actual bladder volume may exceed the displayed result. You should re-aim and rescan the patient. For guidance on how to improve the scan results, see Table 8.

Figure 6. Greater Than (>) Symbol Displayed

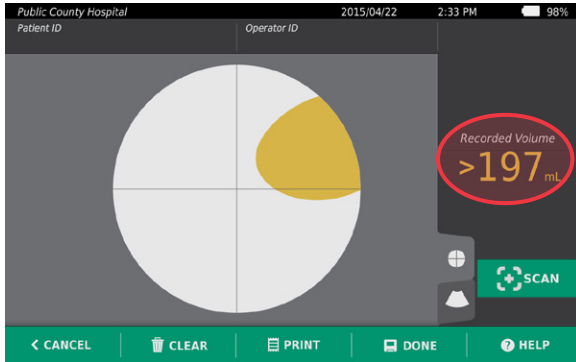

Figure 7. Greater Than (>) Symbol Not Displayed

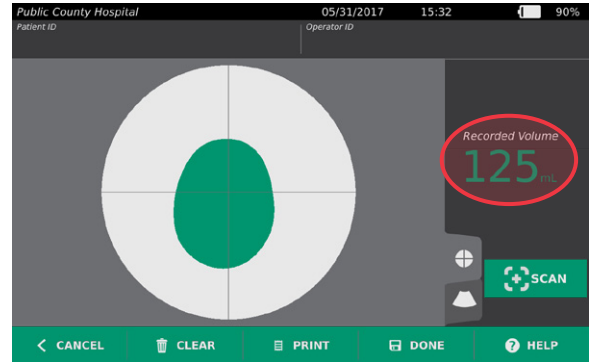



Table 8. Bladder Measurement Accuracy

RESULT	AIMING GUIDANCE	EXAMPLE
Successfully Centered	If the bladder is centered in the field of view, all bladder edges are visible, and there are no gray areas, then the scan was successful, and the results are optimized for accuracy.	
Not Centered	If the bladder is not centered in the field of view, you may move or angle the probe in the direction of the bladder on the display in order to optimize your results.	
EdgeScan	If one side of the bladder is not within the field of view, then a portion of the bladder was not included in the scan. The system displays a greater than symbol (>) before the measured result, indicating the actual bladder volume may exceed the displayed result. Move or angle the probe in the direction of the bladder on the display in order to optimize your results.	
Bladder larger than view	If more than one side of the bladder is not within the field of view, then multiple portions of the bladder were not included in the scan. The system displays a greater than symbol (>) before the measured result, indicating the actual bladder volume may exceed the displayed result. You may attempt to capture the entire bladder by rescanning while applying less pressure to the abdomen; however, the bladder may be larger than the field of view, and it may not be possible to capture the entire bladder within the view.	
Pubic bone interference	If a gray area appears, this indicates that the pubic bone is inside the field of view. Although the bladder may be centered and your measurement may be complete, there is a possibility the pubic bone is obscuring part of the bladder. The system displays a greater than symbol (>) before the measured result, indicating the actual bladder volume may exceed the displayed result. You may move or angle the probe in order to optimize your results.	

- If you want to rescan the patient, on the Results screen, tap **Scan**.  
Repeat the scanning procedure as necessary to adjust your aim or confirm the initial measurement.
- When you are finished scanning, you can review the results in B or C modes. (C-mode is displayed by default.) You can save scan results, and you can print scan results if you have the printer installed.

### VIEW B-MODE IMAGES

- If B-mode images are activated on your system and you want to view them, tap the B-mode icon . Dual-pane B-mode images of the scan appear.

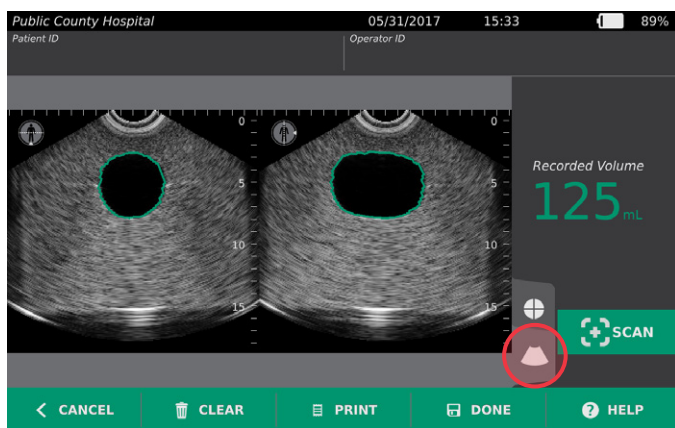

- In the top-left corner of each of the B-mode images, the line through the human figure icon indicates the currently displayed plane. Horizontally swipe the B-mode display to navigate through the scan planes.

### VIEW MULTIPLE SCANS

When you perform more than one scan, the Results screen displays the largest volume obtained. Below the largest volume measurement, the screen indicates the most recent scan volume.

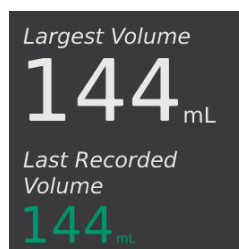

- If you want to show individual scan measurements, tap the **Scan History** arrow.

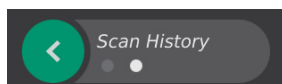

- Tap the scan measurement number to see the scan display.



- Continue to the following procedure, [Print, Save, or Exit an Exam](#).

---

## PROCEDURE 5. PRINT, SAVE, OR EXIT AN EXAM

---

1. If you want to record patient information, tap **Patient ID** and then add patient information using the virtual keyboard. Once an exam is saved, you cannot add patient information.
2. If you want to print the exam results, tap **Print**.

*Note: You can customize the information to be printed. The report always contains the largest measurement and the exam date and time. For more information about adding and customizing information to be printed, see [Configure Printed and PDF Report Settings](#) on page 30.*

3. If you want to save the exam results, tap **Done**. If there are multiple scans for the patient, the system stores the largest measurement.
4. If you want to exit without saving the exam results, tap **Cancel**.

For information about viewing, deleting, and exporting saved exams, see the section [Managing Saved Exams](#) on page 41.

5. Press the **Standby** button . When prompted, confirm that you want the system to enter standby mode, and then wait for it to do so.

---

## PROCEDURE 6. VIEW COST SAVINGS

---

The system calculates and displays information related to cost savings, catheterizations avoided, and UTIs avoided. The default settings can be customized to reflect the rates and costs at your facility. For more information on customizing savings preferences, see [Customize Cost Savings Calculations](#) on page 29.

The system calculates savings since the most recent calculation reset and for the life of the instrument. You can show, configure, and reset cost savings at any time.

1. On the Home screen, tap **Settings**.
2. Tap **Show Savings**. The Settings screen opens to the Show Savings tab.

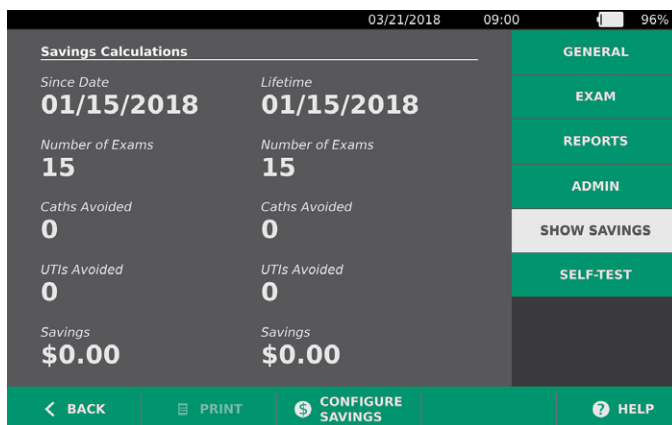

3. If you have a printer and want to print the savings calculations, tap **Print**.
4. When you are finished viewing the savings calculations, tap **Back**. The console returns to the Home screen.



# MANAGING SAVED EXAMS

The system can store saved exams on the instrument or external devices such as USB drives and SD cards. If you scan the patient multiple times during an exam, the system saves the largest measurement.

If no external devices are attached, the system stores saved exams on the instrument. If the system runs out of internal storage, the system warns you before deleting old exams to make room for new ones. The file size of a saved exam may vary, but the system is capable of storing 600 exams within its internal memory.

If a USB drive or SD card is attached, the system stores saved exams on the USB drive or SD card. If an attached USB drive or SD card runs out of storage space, the system allows you to switch drives or cards.

You can move exams from the internal storage to an external USB drive or SD card. For more information, see the procedure [Export Saved Exams](#) on page 43.



Please read the [Warnings & Cautions](#) section before performing the following tasks.

## PROCEDURE 1. RECALL A SAVED EXAM

Once you have saved an exam, it can be recalled using the Saved Scans screen. The Saved Scans screen displays scans saved on the system's internal memory if no external storage devices are attached. If a USB drive or SD card is attached, the Saved Scans screen displays scans saved on the attached storage device.

If there are multiple scan results in the exam, the system stores and displays the largest measurement.

### SORT OR SCROLL SCANS

1. On the Home screen, tap **Saved Scans**.
2. If a keypad appears, key in the PIN for Saved Scans, and then tap **Enter**.

The Saved Scans screen opens, displaying a list of exams saved on the default media. Each of the rows on this list corresponds to an exam.

Date/Time	Result	Patient ID	Operator ID	
05/30/2017 15:58	122 mL	pat003	op003	✕
05/30/2017 15:57	122 mL	pat002	OP002	✕
05/30/2017 15:54	125 mL	PAT001	op001	✕
05/30/2017 15:02	125 mL			✕
05/30/2017 13:25	123 mL			✕
05/30/2017 13:21	127 mL			✕
05/30/2017 13:11	123 mL			✕

Public County Hospital 05/31/2017 15:34 89%

< BACK HELP

3. If you want to sort exams using a different value, tap a sortable field header.

The field headers let you sort the exam list using the following fields. The columns may be sorted in ascending or descending order. The currently selected sorting field is highlighted in white, and an arrow icon indicating the direction of the sort is shown next to the column label.

- Date/Time
  - Patient ID
  - Operator ID
4. If you want to scroll through the exam list, vertically swipe the screen.
  5. If you want to view an exam, tap anywhere along the exam's row. When an exam is selected for review, the results screen for the exam is displayed.

---

## PROCEDURE 2. DELETE A SAVED EXAM

---

1. On the Home screen, tap **Saved Scans**.
2. If a keypad appears, key in the PIN for Saved Scans, and then tap **Enter**.

The Saved Scans screen opens, displaying a list of exams saved on the default media. Each of the rows on this list corresponds to an exam.

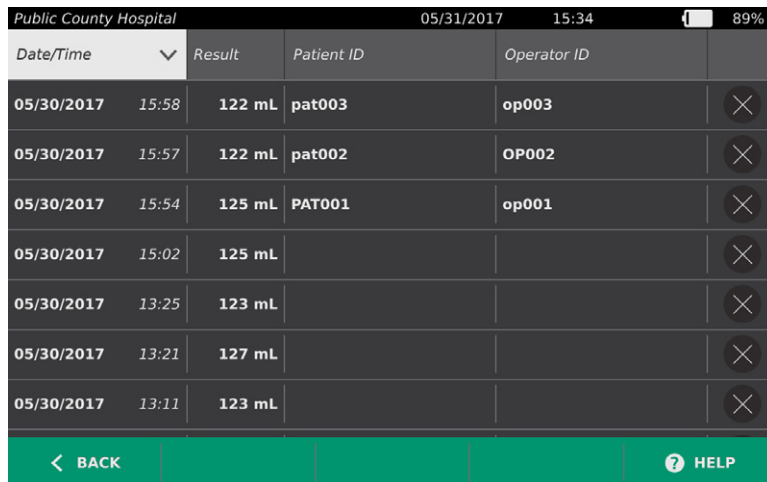

Date/Time	Result	Patient ID	Operator ID	
05/30/2017 15:58	122 mL	pat003	op003	✕
05/30/2017 15:57	122 mL	pat002	OP002	✕
05/30/2017 15:54	125 mL	PAT001	op001	✕
05/30/2017 15:02	125 mL			✕
05/30/2017 13:25	123 mL			✕
05/30/2017 13:21	127 mL			✕
05/30/2017 13:11	123 mL			✕

3. If it is not visible in the list, sort or scroll saved exams to display the one you want. For more information on finding exams, see [Recall a Saved Exam](#) on page 41.
4. Tap the **Delete** button ✕ at the right end of the exam row.
5. On the confirmation dialog box, tap **Yes**.

*Note: You may also delete a saved exam that is currently being viewed. To delete an opened exam, at the bottom of the screen, tap **Delete**.*

## PROCEDURE 3. EXPORT SAVED EXAMS

Use the following procedure to move exams from the system's internal storage to an external USB drive or SD card.

By default, saved scans are retained in the system's internal storage. When you insert a USB drive or SD card into the console, the system immediately begins viewing the new media for saved scans. If no scans have previously been saved to the external media, the Saved Scans screen appears blank. Scans you have saved on the system's internal memory have not been lost and can be exported to the new media by selecting the Export Exams option.

Scans are saved with unique file names, so saving new scans does not overwrite exams already stored on the USB drive or SD card.

Exported scan information is stored in PDF and graphic formats, so it can be viewed on other devices. Each scan is stored on a folder on the USB drive or SD card. Each folder contains:

- A PDF document containing:
  - Patient information
  - C-mode view of the scan (if the C-mode crosshairs image is enabled in reports)
  - B-mode views of the scan (if B-mode images are enabled in reports)
- Individual graphic files, in PNG format, for each B-mode plane of the scan.
- A graphic file, in PNG format, for the C-mode view of the scan.

1. Insert a USB drive or SD card into the port on the right side of the console.

*Note: Insert only one USB drive or SD card at a time. If you insert multiple devices, the console recognizes only the first device.*

2. On the Home screen, tap **Saved Scans**.
3. If a keypad appears, key in the PIN for Saved Scans, and then tap **Enter**.
4. On the Saved Scans screen, tap **Export Exams**.

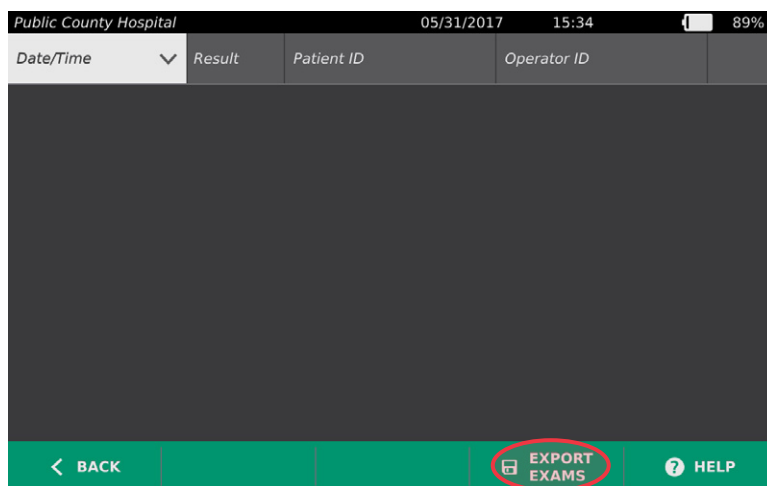

5. A verification screen appears. Tap **OK** to confirm you want to move exams stored on the console to the external storage device. Do not remove the USB drive or SD card until export is complete.

# CLEANING & DISINFECTING



Please read the [Warnings & Cautions](#) section before performing the following tasks.

Cleaning and disinfecting the BladderScan Prime Plus system is an important part of using and maintaining it. Prior to each use, ensure all system components have been cleaned and disinfected according to the guidance provided in Table 9.

Table 9. *BladderScan Prime Plus System Risk Classification*

COMPONENT	PACKAGED	USE	SPAULDING CLASSIFICATION	CLEAN	DISINFECTION LEVEL	
					Low	High
Console	Nonsterile	Reusable	Noncritical	■		
Probe Cable	Nonsterile	Reusable	Noncritical	■		
Probe	Nonsterile	Reusable	Noncritical		■	

■ Selected boxes show minimum disinfection level requirement.

## CLEANERS & DISINFECTANTS

### DISINFECTION EFFICACY

The following table lists the low-level disinfectant (LLD) classes that have demonstrated efficacy with the system. For information about the long-term effect of solutions on system materials, see the following section, [Compatibility](#).

Table 10. *Validated Disinfectants*

ACTIVE INGREDIENT CLASS	TESTED ACTIVE INGREDIENTS
Alcohols (or alcohol with Quat)	55% isopropyl alcohol
Chlorine & chlorine compounds	0.55% sodium hypochlorite (bleach)
Quaternary ammonium (Quat)	0.5% quaternary ammonium compounds
Hydrogen peroxide	2.0% hydrogen peroxide

## COMPATIBILITY

Table 11 shows the disinfectant and cleaning products that have demonstrated compatibility with system materials. Results with compatible solutions may vary based on exposure periods and device handling. These solutions have not been tested for biological efficacy. Verathon cannot guarantee the compatibility of solutions not included in Table 11. Ensure that you adhere to an inspection schedule as described in [Regular Inspections](#) on page 47.

Availability of cleaning and disinfection products varies by country, and Verathon is unable to test products in every market. For more information, please contact Verathon Customer Care or your local representative. For contact information, visit [verathon.com/service-and-support](http://verathon.com/service-and-support).

Table 11. *Compatible Cleaning Solutions and Disinfectants*

PRODUCT	ACTIVE CLASS	USE	
		Clean	Disinfect
GAMA Healthcare Clinell Universal Wipes	Quaternary ammonium	■	■
Clorox Healthcare Bleach Germicidal Wipes	Chlorine & chlorine compounds	■	■
Clorox Healthcare Hydrogen Peroxide Cleaner	Hydrogen peroxide with alcohol	■	■
Metrex CaviCide	Alcohol with quaternary ammonium	■	■
Metrex CaviWipes	Alcohol with quaternary ammonium	■	■
PDI Sani-Cloth AF3	Quaternary ammonium	■	■
PDI Sani-Cloth Active	Quaternary ammonium	■	■
PDI Sani-Cloth Bleach	Chlorine & chlorine compounds	■	■
PDI Sani-Cloth Plus	Alcohol	■	■
PDI Super Sani-Cloth	Alcohol	■	■
Septiwipes	Quaternary ammonium	■	■
Tristel Duo for Ultrasound	Chlorine & chlorine compounds	■	■
Virusolve+	Alcohol	■	■
Wip'Anios	Alcohol with quaternary ammonium	■	■

## BEST PRACTICES & INSTRUCTIONS

*Cleaning* is the removal of all visible soil or contaminants, and *disinfection* is the process of destroying pathogenic organisms or rendering them inert. When cleaning, ensure all foreign matter is removed. This allows the active ingredients of the disinfectant to reach all the surfaces of the device.

Please adhere to the following best practices:

- Do not let gel or other contaminants dry on the system. This makes removal more difficult.
- Change gloves if they become visibly soiled.
- Always wipe in the direction from a clean surface towards a dirty surface.
- Minimize overlap on the wiping pattern.
- If a towelette becomes dry or soiled, replace it with a fresh one.
- Do not reuse dry or soiled towelettes.

## PROCEDURE 1. CLEAN & DISINFECT THE SYSTEM

### CLEAN THE CONSOLE, PROBE & CABLE

1. If the system is on, press the **Standby** button . When prompted, confirm that you want the system to enter standby mode, and then wait for it to do so.
2. Wipe any ultrasound gel completely off of the probe.
3. Using a wet cloth or a towelette indicated for cleaning medical devices and following the manufacturer's instructions, wipe the console, probe, and probe cable. Repeat as needed to ensure all visible contamination is removed.
4. If the console is visibly wet, you may use a clean soft cloth or paper towel to remove any residual cleaning solution.



### DISINFECT THE PROBE

5. Using a germicidal towelette with an active ingredient class from Table 10, wipe the probe dome according to the instructions provided by the manufacturer. Re-wipe the area as needed to ensure that it remains wet for the full exposure period.
6. Allow the probe to air dry. Cleaning and disinfection is complete, and the system is ready for use.



# MAINTENANCE & SAFETY

---

## REGULAR INSPECTIONS

Verathon offers certification services through authorized BladderScan service representatives or a Verathon service center. Certification service includes comprehensive inspection and testing of the instrument. For more information, please contact your authorized Verathon Service Center, your local BladderScan distributor, or Verathon Customer Care.

### WEEKLY INSPECTIONS

Once a week, you should inspect the console, probe, probe cable, power supply, power cords, batteries, and plugs for damage or cracks. Cracks that allow the ingress of fluid into the console or probe may affect the performance of the instrument. Other than the maintenance included in this manual, all service and repairs must be completed by an authorized BladderScan service representative or Verathon Service Center. For more information, contact Verathon Customer Care or your local representative.

## CALIBRATION

The system does not require routine or periodic calibration under normal use.

If your facility or regional regulations require periodic maintenance, refer to the procedure [Complete a CaliScan Test](#) on page 51, which can be used to confirm proper probe functionality.

## SYSTEM SOFTWARE

Verathon may release software upgrades for the system. Software upgrades are supplied directly by Verathon or an authorized representative. For information about how to upgrade the device software, see [Update the Software](#) on page 50.

Do not perform any software upgrades from third-party vendors or attempt to modify the existing software. Doing so may damage the system and void the warranty.

## DEVICE DISPOSAL

The system and accessories may contain mineral oils, batteries, and other environmentally hazardous materials. When the instrument has reached the end of its useful service life, return the device and related accessories to a Verathon Service Center for proper disposal. Alternatively, follow your local protocols for hazardous waste disposal.

## WARRANTY

Information about the manufacturer's warranty is included with the product. Extended warranties may be available for your system. For more information, contact Verathon Customer Care or your local representative.

# MAINTENANCE PROCEDURES

## PROCEDURE 1. LOAD THERMAL PAPER INTO THE PRINTER



Please read the [Warnings & Cautions](#) section before performing the following task.

The system automatically displays a message when the printer is out of paper.

1. Slide the printer door upward to unlock it, and then rotate the door down to open. Placing your thumb on the outside of the printer and squeezing can facilitate easy opening.
2. If this is the first time you are loading the printer, there may be a sheet of paper in the printer mechanism. Remove the paper sheet.
3. Place a roll of thermal paper inside the door as shown so that the loose end of the paper exits on the top of the roll, on the side closest to the console.



4. Hold the paper end so that it will protrude from the top of the printer, and then close the printer door. Ensure that the door clicks into place.



5. Tear off any excess paper protruding from the printer. For best results, pull the paper diagonally, starting the cut on one side of the paper, and finishing on the other.



It is recommended that you clean the printer contacts on both the printer and the console when the printer is disconnected from the console, but not more frequently than once per year except in case of malfunction. For more information about cleaning the printer contacts, see Step 7 through Step 10 of the procedure [Troubleshoot Printer Power Issues](#) on page 56.

## PROCEDURE 2. RUN A SELF-TEST

The BladderScan Prime Plus self-test function completes self-diagnostic testing on the following:

- Internal memory (and external devices, if any)
- Hardware components, including the console, installed battery, probe, and printer, if attached
- BladderScan Prime Plus software

1. On the Home screen, tap the **Settings** icon, and then tap **Self-Test**. The Settings screen opens to the Self-Test tab, where the instrument completes the self-test and displays the results.

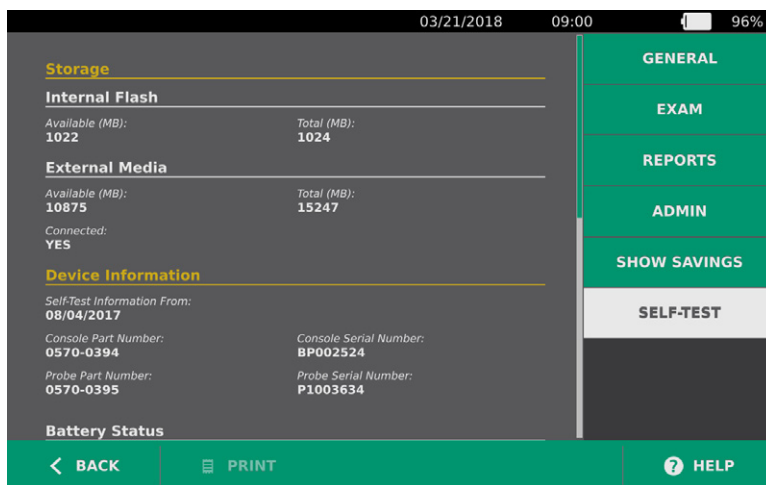

2. Scroll through the on-screen test results by vertically swiping with your finger on the touchscreen.
3. If the screen indicates any failed tests or abnormal results, contact Verathon Customer Care or your local representative.
4. If you want to print the self-test results, tap **Print**.
5. When you are finished viewing the test results, tap **Back**. The console returns to the Home screen.

## PROCEDURE 3. UPDATE THE SOFTWARE

From time to time, Verathon may make software updates available for your system. To inquire about the availability of a software update, contact Customer Care or your local representative.

1. Export any exams you need to retain. For more information, see [Export Saved Exams](#) on page 43.
2. Ensure that the probe is attached to the console.
3. If there are any USB drives or SD cards connected to the console, remove them.
4. Ensure that the system is turned on and the battery is at least 50% charged.
5. Insert the USB drive containing a valid software update package into the console.



6. On the Home screen, tap **Settings**, and then tap **Admin**.
7. On the Admin tab, tap **Update Software**.

The system begins updating and may restart during the update process. Do not remove the battery or the USB drive while the update is in process.

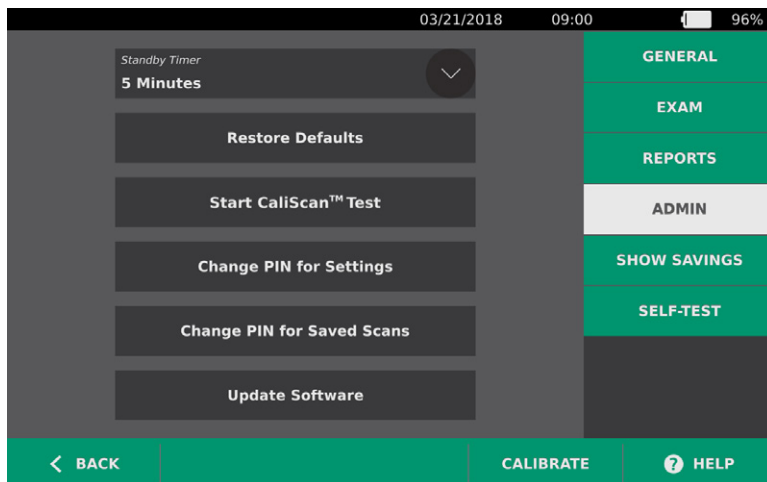

8. When instructed to do so, remove and reinsert the battery. The system restarts, and the software update is complete.

## PROCEDURE 4. COMPLETE A CALISCAN TEST

The BladderScan Prime Plus system includes the *CaliScan* feature, which tests the probe's mechanical components and transducer function. The CaliScan test can be used for preventative maintenance or as a diagnostic tool if a probe has been dropped or in storage for an extended amount of time.

*Note: The CaliScan test evaluates only the mechanical condition of the probe. It does not calibrate the BladderScan system.*

1. On the Home screen, tap **Settings**, and then tap **Admin**.
2. Tap **Start CaliScan Test**.

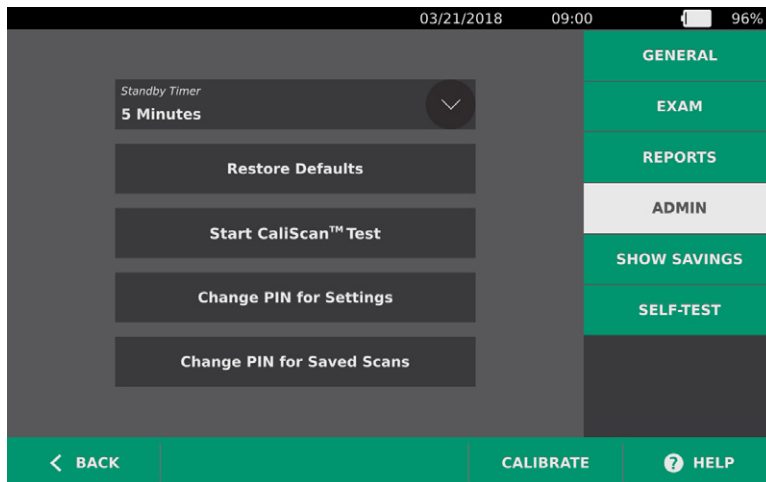

3. Review the test instructions, and then tap **Test**. The instrument begins to test probe components. A message and process indicator appear while the test is in process.

*Note: Once the test has started, do not press the Standby button or disconnect the probe from the console.*

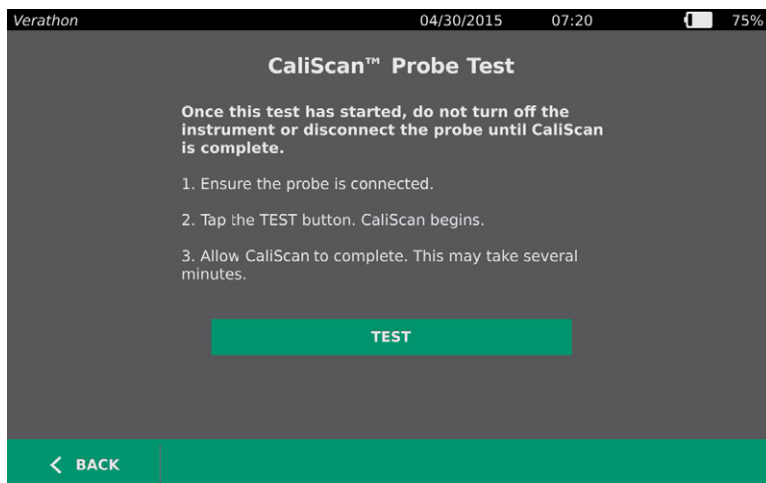

4. If the probe passes the test, a message on the console indicates that the probe has passed. When you are done reviewing the results, tap **Back**.

If the probe fails the test, a message on the console indicates failure. Contact Verathon Customer Care or your local representative.

# HELP & TROUBLESHOOTING

## HELP RESOURCES

### PROCEDURE 1. WATCH THE ONBOARD TUTORIAL

The BladderScan Prime Plus system includes an onboard tutorial with instructions on how to scan and manage exams. It is recommended that you watch the tutorial prior to using the system. The tutorial does not include an audio track.

*Note: The setting and configuration screens include access to screen-specific help text. To see help text on any setting or configuration screen, tap **Help**.*

1. On the Home, Results, or Saved Scans screens, tap **Help**. The Tutorial Control screen opens, and the tutorial begins to play.
  - If you start the tutorial from the Home screen, the entire tutorial plays.
  - If you start the tutorial from any other screen, the tutorial begins at the relevant section.
2. While the tutorial is playing you can:
  - View the previous frame of the tutorial (tap **Previous**)
  - View the next frame of the tutorial (tap **Next**)
  - Pause the tutorial (tap **Pause**) or continue the tutorial when paused (tap **Play**)
  - When you are done viewing the tutorial, tap **Back**.

### CUSTOMER SERVICES RESOURCES

Verathon provides several customer service resources, described in the table below.

RESOURCE	DESCRIPTION
In-service USB	USB flash drive included with your system that includes instructions on using the instrument.
Onboard help tutorial	A training module installed on your BladderScan is available by pressing <b>Help</b> from the Home, Aiming, and Results screens.
Onboard help text	Screen-specific online help text is available by pressing <b>Help</b> from the setting and configuration screens.
Phone support	Please refer to the list of Verathon Customer Care resources available at <a href="https://www.verathon.com/service-and-support">verathon.com/service-and-support</a> .

## DEVICE REPAIR

The system components are not user-serviceable. Verathon does not make available any circuit diagrams, component parts lists, descriptions, or other information that would be required for repairing the device and related accessories. All service must be performed by a qualified technician. If you have any questions, contact Verathon Customer Care or your local representative.



Please read the [Warnings & Cautions](#) section.

## TROUBLESHOOTING PROCEDURES

### PROCEDURE 1. TROUBLESHOOT CONSOLE POWER ISSUES

1. If the instrument does not turn on, the battery may be dead or discharged. Replace a discharged battery with a fully-charged battery.
2. If the battery charge is too low for the instrument to function, recharge the battery according to the instructions in the procedure [Charge the Battery](#) on page 17.
3. If the instrument has stopped responding even with a charged battery, perform a system reset by pressing and holding the reset button for three seconds. The reset button is located next to the battery well.

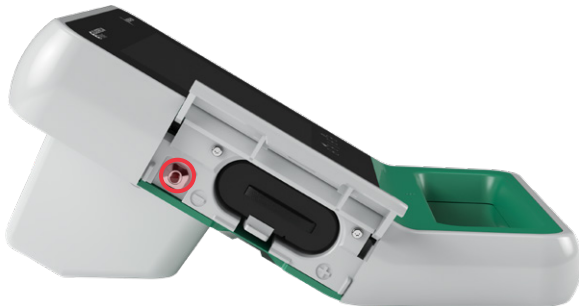

4. If the instrument does not respond, contact Verathon Customer Care.

## PROCEDURE 2. TROUBLESHOOT PROBE CONNECTION ISSUES

If the console displays an error message indicating that the probe is not attached, use this procedure in order to troubleshoot the issue.

1. Press the **Standby** button (⏻). When prompted, confirm that you want the system to enter standby mode, and then wait for it to do so.
2. Press the **Standby** button (⏻) again to activate the system.
3. If the message still appears, replace the battery according to the instructions in the procedure [Insert a Battery](#) on page 25.
4. If the message still appears, contact Verathon Customer Care.

## PROCEDURE 3. TROUBLESHOOT PROBE AIMING ISSUES

If a scan or aiming during pre-scan is unsuccessful or off-center and moving the probe in the expected direction of the bladder moves the bladder further off-center, use this procedure to troubleshoot the issue.

1. On the Home screen, verify that the selected position reflects your position in relation to the patient.

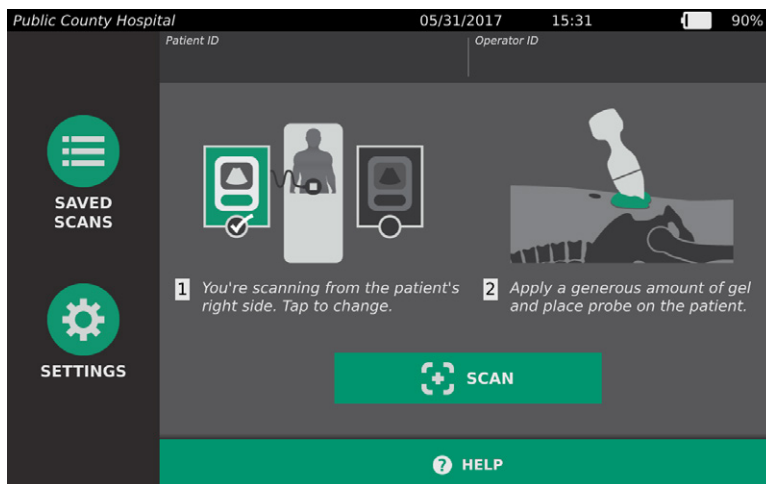

2. Hold the probe by grasping it with the probe cable running up your wrist and forearm.

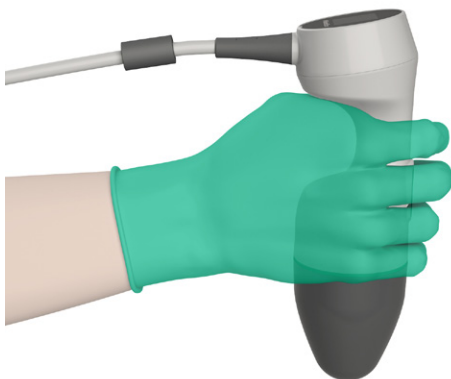

3. With the probe midline on the patient, ensure that the probe cable is oriented at 90 degrees to the sagittal plane.

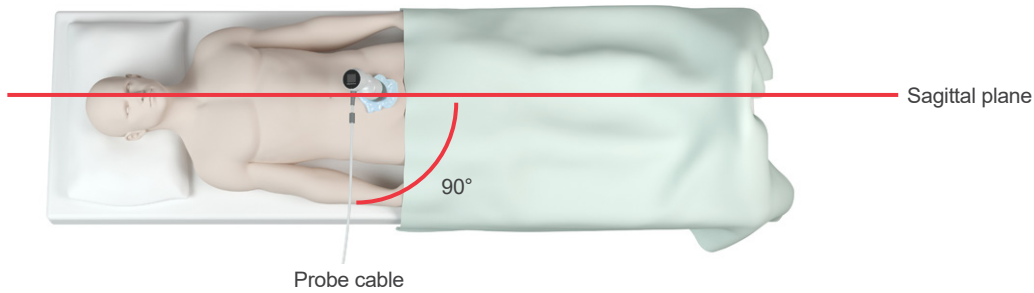

4. Look at the display on the top of the probe. Ensure that the head of the icon points in the same direction as the head of the patient.

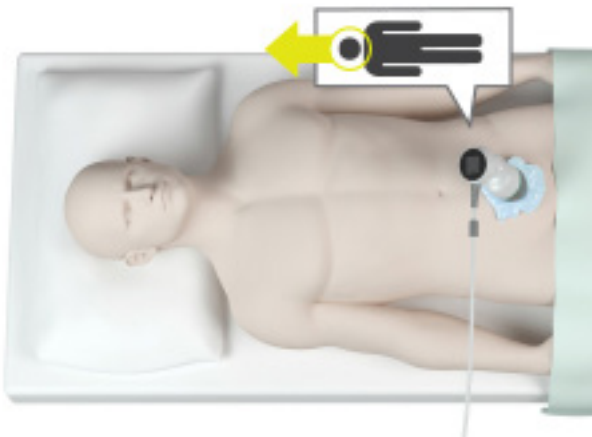

5. After verifying the selected orientation, probe placement, and probe display, rescan the patient. Hold the probe steady while the scan is in process. For detailed scanning instructions, see [Measure Bladder Volume](#) on page 35.

---

## PROCEDURE 4. RESTORE FACTORY DEFAULTS

---

Use the following procedure to restore the original settings for the system. Running this procedure removes all user information—including customized system settings, cost savings calculations, and saved scans—from the instrument. Do not restore factory defaults if you want to retain this information.

1. On the Home screen, tap **Settings**, and then tap **Admin**.
2. Tap **Restore Defaults**.
3. If a keypad appears, key in the PIN for Settings, and then tap **Enter**.
4. If you want to restore the system defaults, tap **Yes**. The system restores factory settings and then restarts.

## PROCEDURE 5. TROUBLESHOOT PRINTER POWER ISSUES



Please read the [Warnings & Cautions](#) section before performing the following task.

### IMPORTANT

To avoid damaging the equipment, remove the battery prior to connecting or disconnecting the printer or console base.

If the printer is not responding when **Print** is tapped on the console, then you may need to inspect and clean the electrical contacts.

1. Ensure the battery is removed from the instrument.
2. If the console is mounted on a mobile stand, do the following:
  - Securely hold the console so that it does not fall.
  - Move the locking pin to the unlocked (horizontal) position.
  - Move the quick-release lever to the unlocked (horizontal) position.

The console is released from the mobile stand.

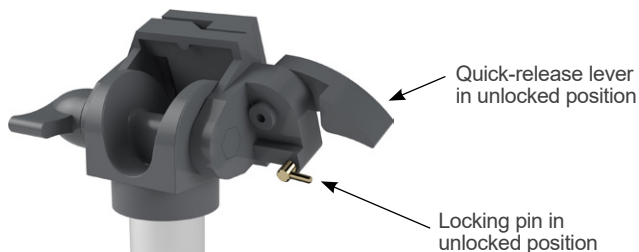

3. Place the console screen-side-down on a flat, non-abrasive surface.
4. Using a screwdriver with a Phillips bit, loosen the screws securing the printer to the console.
5. If a mounting bracket is installed over the printer, remove the bracket and screws, and then set them aside.

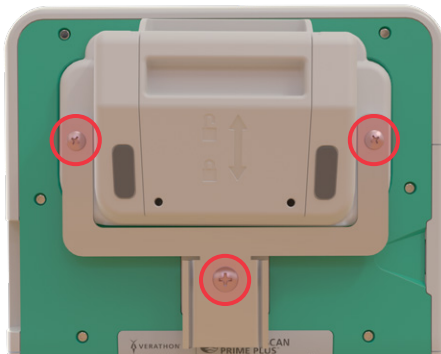

6. Lift the printer away from the console.



- Using a cotton swab dipped in 70% isopropyl alcohol (IPA), clean the individual contacts on the printer. Do not push the contacts sideways or any farther than halfway down.

*Note: Use only the minimum amount of IPA necessary to clean the contacts. Ensure that excess IPA does not enter the interior of the printer.*



- Inspect the printer contacts and verify the following:
  - The contacts are clean and free from corrosion, lint, or debris.
  - The contacts appear to be straight.
  - The contacts are uniformly spaced.
- Repeat Step 7 in order to clean the corresponding contacts on the console.

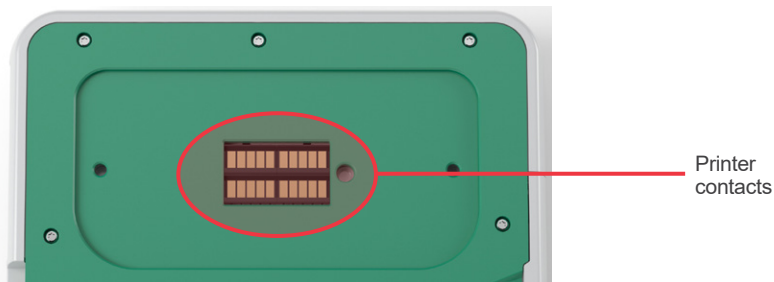

- Allow the contacts on the console and the printer to dry completely, and then reattach the printer to the console according to the instructions in the procedure [Attach the Console Base or Printer](#) on page 20.
- If you would like to reattach the console to a mobile stand, complete the procedure [Attach the System to the Mobile Cart \(Optional\)](#) on page 21.
- If the printer continues to be unresponsive, contact Verathon Customer Care.

## PROCEDURE 6. TROUBLESHOOT IRREGULAR PRINTOUTS



Please read the [Warnings & Cautions](#) section before performing the following task.

If the printer is producing irregular printouts, you may need to clean the print head.

- Press the **Standby** button . When prompted, confirm that you want the system to enter standby mode, and then wait for it to do so.
- Slide the printer door upward to unlock it, and then rotate the door down to open. Placing your thumb on the outside of the printer and squeezing can facilitate easy opening.

3. If a thermal paper roll is in the printer, remove it.



4. Using a cotton swab dipped in isopropyl alcohol (IPA), wipe along the length of the print head. Do not use your fingers or any hard or abrasive surfaces to clean the print head.



5. Allow the print head to dry completely.
6. Ensure that there is no lint or visible debris on the print head.

7. Verify the position of the printer driver roller in the printer door:
  - The printer driver roller plastic bushings should rest inside the light gray plastic clips in the printer door as shown. The white gear should be outside the clip.
  - If the printer driver roller has fallen out of the gray clips, replace the driver roller according to the instructions in the procedure [Replace the Printer Drive Roller](#) on page 61.



8. Load the thermal paper and close the printer door according to the instructions in the procedure [Load Thermal Paper into the Printer](#) on page 48.
9. If the printer continues to produce irregular printouts, contact Verathon Customer Care.

## PROCEDURE 7. CLEAR A PAPER JAM

If the printer is jammed, use this procedure in order to remove the paper jam.

1. Press the **Standby** button (⏻). When prompted, confirm that you want the system to enter standby mode, and then wait for it to do so.
2. Slide the printer door upward to unlock it, and then rotate the door down to open. Placing your thumb on the outside of the printer and squeezing can facilitate easy opening.



3. Pull the paper gently in order to clear the paper jam. If necessary, pull any ripped or folded paper out of the printer and remove any bits of paper that have become separated from the roll.
4. Verify the position of the printer drive roller in the printer door:
  - The printer drive roller's plastic bushings should rest inside the light gray plastic clips in the printer door as shown. The white gear should be outside the clip.
  - If the printer drive roller has fallen out of the gray clips, replace it according to the instructions in the procedure [Replace the Printer Drive Roller](#) on page 61.

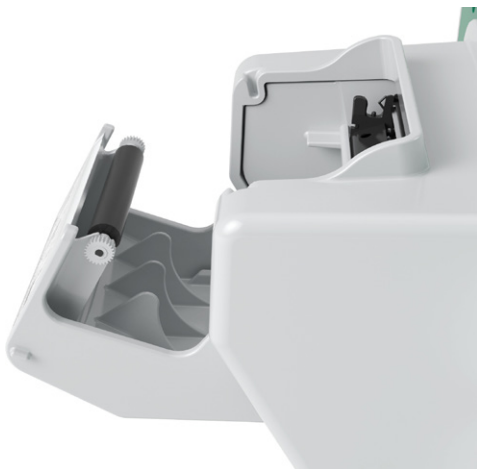

5. Load the thermal paper and close the printer door according to the instructions in the procedure [Load Thermal Paper into the Printer](#) on page 48.
6. If the paper on the outside of the printer is ripped or torn, tear it off, pulling to one side to aid in cutting.
7. If you cannot clear the paper jam or the printer continues to jam, please contact Verathon Customer Care.

---

## PROCEDURE 8. REPLACE THE PRINTER DRIVE ROLLER

---

The printer drive roller can fall out if the printer is dropped. If the roller has fallen out, printing may be irregular or not occur at all. You may be unable to close the printer door.

1. Press the **Standby** button (⏻). When prompted, confirm that you want the system to enter standby mode, and then wait for it to do so.
2. Slide the printer door upward to unlock it, rotate the door down to open, and then remove the paper roll.



3. Look for the printer drive roller inside the light gray plastic clips in the printer door.
4. If the printer drive roller has fallen out, place the drive roller as shown, with the white gear on the right and the plastic bushings centered between the light gray clips in the printer door.
5. Push down on the printer drive roller and ensure that it snaps into the light gray clips in the printer door and is held in place on both sides.



6. Load the thermal paper and close the printer door according to the instructions in the procedure [Load Thermal Paper into the Printer](#) on page 48.
7. If the printer continues to malfunction, contact Verathon Customer Care.

# PRODUCT SPECIFICATIONS

## SYSTEM SPECIFICATIONS

### OVERALL SYSTEM SPECIFICATIONS

Table 12. General System Specifications

ITEM	SPECIFICATION	
<b>General Specifications</b>		
Classification	Internally powered, Type BF	
Expected product life	Console	7 years
	Probe	7 years
	Printer	7 years
	Battery charger	7 years
Ingress protection (IP) against water	Console	IPX0
	Probe	IPX4
	Printer	IPX0
	Battery charger	IPX0
	Battery	IPX0
<b>Operating Conditions</b>		
Use	Indoor	
Temperature	+10 to +40°C (50 to 104°F)	
Relative humidity	20 to 75%	
Ambient air pressure	+700 hPa to 1060 hPa	
<b>Storage Conditions</b>		
Use	Indoor	
Temperature	-10 to +60°C (14 to 140°F)	
Relative humidity	15 to 85%	
Ambient air pressure	+600 hPa to 1060 hPa	

Table 13. Ultrasound Acoustic Output Parameters (IEC Standard)

INDEX LABEL			MI	TIS		TIB		TIC
				AT SURFACE	BELOW SURFACE	AT SURFACE	BELOW SURFACE	
<b>Maximum index value*</b>			$3.65 \times 10^{-1}$	$2.03 \times 10^{-3}$		—	—	—
<b>Index component value</b>				$2.03 \times 10^{-3}$	$2.03 \times 10^{-3}$	—	—	
Acoustic Parameters	$p_{r,\alpha}$ at $z_{MI}$	(MPa)	$5.81 \times 10^{-1}$					
	$P$	(mW)		$5.64 \times 10^{-2} - 6.5 \times 10^{-1}$		—	—	—
	$P_{1 \times 1}$	(mW)		$1.38 \times 10^{-2} - 1.6 \times 10^{-1}$		—	—	
	$z_s$	(cm)			2.7–3.3			
	$z_b$	(cm)					—	
	$z_{MI}$	(cm)	3.3					
	$z_{pii,\alpha}$	(cm)	3.3					
	$f_{awf}$	(MHz)	2.53	1.82–2.53		—	—	—
Other Information	$p_{rr}$	(Hz)	408					
	$s_{rr}$	(Hz)	5.1					
	$n_{pps}$		1					
	$I_{pa,\alpha}$ at $z_{pii,\alpha}$	(W/cm <sup>2</sup> )	6.9					
	$I_{spta,\alpha}$ at $z_{pii,\alpha}$ or $z_{sii,\alpha}$	(mW/cm <sup>2</sup> )	$1.4 \times 10^{-1}$					
	$I_{spta}$ at $z_{pii}$ or $z_{sii}$	(mW/cm <sup>2</sup> )	$2.4 \times 10^{-1}$					
	$p_r$ at $Z_{pii}$	(MPa)	$7.7 \times 10^{-1}$					
Operating Control Conditions	Combined pulse			●	●			
	2.6 MHz pulse		●					

\* MI and TI values are both below 1.0.

— These values have been omitted because they refer to uses other than the intended use of this system.

Table 14. Ultrasound Acoustic Output Parameters (FDA Format)

The data in each column corresponds to the highest measured global maximum value for each of the parameters in the column title (MI,  $I_{SPTA.3}$ ,  $I_{SPPA.3}$ ), measured over three probes.

ACOUSTIC OUTPUT			MI	$I_{SPTA.3}$ (mW/cm <sup>2</sup> )	$I_{SPPA.3}$ (W/cm <sup>2</sup> )	
Global Maximum Value			0.384*	0.160	8.52	
Associated Acoustic Parameter	$p_{r.3}$	(MPa)	0.625			
	$P_0$	(mW)		0.771	0.681	
	$f_c$	(MHz)	2.65	1.82–2.65	2.65	
	$Z_{sp}$	(cm)	3.40		3.40	
	Beam dimensions	$x_{-6}$ (cm)				0.371
		$y_{-6}$ (cm)				0.406
	PD	( $\mu$ sec)	1.04		1.04	
	PRF	(Hz)	408		408	
	EDS	Az. (cm)			5.29	
Ele. (cm)				1.28		

\* MI value is below 1.0.

## ACCURACY SPECIFICATIONS

Table 15. Accuracy Specifications

SPECIFICATION	DESCRIPTION	
Bladder volume range	0 to 999 mL	
Volume accuracy	greater than 100 mL	$\pm 7.5\%$
	0–100 mL	$\pm 7.5$ mL

The following examples show how the accuracy ranges shown in Table 15 may affect reported volume measurements.

- If the measurement is greater than 100 mL, the accuracy range is  $\pm 7.5\%$  and is calculated as follows:  
 $240 \text{ mL} \times 7.5\% = 18 \text{ mL}$   
 $240 \pm 18 \text{ mL} = \mathbf{222\text{--}258 \text{ mL}}$
- If the measurement is 0–100 mL, the accuracy range is  $\pm 7.5$  mL and is calculated as follows:  
 $80 \text{ mL} \pm 7.5 \text{ mL} = \mathbf{73\text{--}88 \text{ mL}}$  (rounded to the nearest whole number)

The accuracy specifications assume the instrument is being used according to the instructions provided by Verathon while scanning a tissue-equivalent phantom.

While the upper threshold of the accuracy range is 999 mL, the system is capable of detecting and displaying bladder volumes above 999 mL. Verathon cannot guarantee the accuracy of measurements outside of the stated specifications.



# COMPONENT SPECIFICATIONS

## CONSOLE SPECIFICATIONS

Table 16. Console Specifications

ITEM	SPECIFICATION
<b>General Specifications</b>	
Height	125 mm (4.92 in)
Width	227 mm (8.94 in)
Depth	259 mm (10.20 in)
Weight	1770 g (3.90 lbs)
Display	1280 x 800 pixels
<b>Electrical Specifications</b>	
Input	Verathon Supplied Battery, 11.1 V DC
Output	USB Ports, 5 V DC at 100 mA maximum from each port
Insulation	Type BF

## PROBE SPECIFICATIONS

Table 17. Probe Specifications

ITEM	SPECIFICATION
<b>General Specifications</b>	
Height	196 mm (7.70 in)
Width	62 mm (2.43 in)
Depth	62 mm (2.43 in)
Weight	580 g (1.28 lbs)
Display	144 x 168 pixels
Cable	1.8 m (6.0 ft)

## PRINTER SPECIFICATIONS

Table 18. Printer Specifications

SPECIFICATION	DESCRIPTION
<b>General Specifications</b>	
Height	70 mm (2.76 in)
Width	164 mm (6.45 in)
Depth	90 mm (3.54 in)
Weight (without paper)	352 g (0.78 lbs)
Resolution	8 dots/mm (203 dots/in)
Dot size	0.125 mm by 0.12 mm (0.005 in by 0.005 in)
Printing width	48 mm (1.89 in), or 384 dots/line

## BATTERY SPECIFICATIONS

The system includes two lithium-ion batteries. A battery symbol on the touchscreen display is always present, indicating how much power remains and when the battery needs to be changed. You can change the battery whenever necessary.

Adhere to the following recommendations and guidance:

- Use only the battery charger provided with the system. Any other battery charger may damage the batteries.
- Consider replacement of the battery if the time between battery charges is significantly reduced and is affecting your use of the Prime system. Contact Verathon Customer Care or your local representative to order replacement batteries.

*Note: Verathon 6.4 Ah/70 Wh batteries (part number 0400-0155) can also be used with this system.*

Table 19. Battery Specifications

CONDITION	DESCRIPTION
<b>General Specifications</b>	
Battery type	Lithium Ion (Li-Ion)
Height	23 mm (0.89 in)
Width	151 mm (5.94 in)
Depth	59 mm (2.32 in)
Weight	326 g (0.72 lbs)
<b>Electrical Specifications</b>	
Battery life	A fully charged battery will typically provide over 24 hours of normal operating use between charges
Charging time	2.5 hours (typical)
Rated capacity	4.6 Ah, 51 Wh
Nominal voltage	11.1 V
Max charging voltage	12.6 V

## BATTERY CHARGER SPECIFICATIONS

Note: The Verathon Smart Battery Charger (part number 0400-0157) can also be used with this system.

Table 20. Battery Charger Specifications

SPECIFICATION	DESCRIPTION
<b>General Specifications</b>	
Height	58 mm (2.30 in)
Width	124 mm (4.89 in)
Depth	175 mm (6.89 in)
Weight	385 g (0.85 lbs)
<b>Electrical Specifications</b>	
Input voltage	24 V DC
Input frequency	DC
Input current	2.5 A
Input connection	2.5 mm (0.1 in), center positive
Output	18 V DC max, 4 A max
Insulation	Protection Class III
Fuses	No user replaceable fuses

## POWER ADAPTER SPECIFICATIONS

Table 21. Charger Power Adapter Specifications

SPECIFICATION	DESCRIPTION
<b>Electrical Specifications</b>	
Input voltage	100–240 V AC, single phase
Input frequency	50–60 Hz
Input current	1.4 A max
Input connection	IEC C13 connection, line cord plug NEMA 5-15 (North America), AS 3112 (Australia), CEE 7/4 (Europe), BS 1363 (United Kingdom)
Output	24 V DC / 0–2.71 A
Insulation	10 Megaohm for 500 V DC
Fuses	Automatic Over Voltage Protection (OVP), Short Circuit Protection (SCP), Over Current Protection (OCP)

# ELECTROMAGNETIC COMPATIBILITY

The system is designed to be in compliance with IEC 60601-1-2, which contains electromagnetic compatibility (EMC) requirements for medical electrical equipment. The limits for emissions and immunity specified in this standard are designed to provide reasonable protection against harmful interference in a typical facility.

The system complies with the applicable essential performance requirements specified in IEC 60601-1 and 60601-2-37. Results of immunity testing show that the essential performance of the system is not affected under the test conditions described in the following tables. For more information about the essential performance of the system, see [Essential Performance](#) on page 1.

## ELECTROMAGNETIC EMISSIONS

*Table 22. Guidance and Manufacturer’s Declaration—Electromagnetic Emissions*

The system is intended for use in the electromagnetic environment specified below. The customer or the user of the system should ensure that it is used in such an environment.

EMISSIONS TEST	COMPLIANCE	ELECTROMAGNETIC ENVIRONMENT – GUIDANCE
RF emissions CISPR 11	Group 1	The system uses RF energy only for its internal function. Therefore, its RF emissions are very low and are not likely to cause any interference in nearby electronic equipment.
RF emissions CISPR 11	Class A	The system is suitable for use in all establishments other than domestic and those directly connected to the public low-voltage power supply network that supplies buildings used for domestic purposes.
Harmonic emissions IEC 61000-3-2	Not applicable	
Voltage fluctuations/ flicker emissions IEC 61000-3-3	Not applicable	

# ELECTROMAGNETIC IMMUNITY

Table 23. Guidance and Manufacturer’s Declaration—Electromagnetic Immunity

The system is intended for use in the electromagnetic environment specified below. The customer or the user of the system should ensure that it is used in such an environment.

IMMUNITY TESTS	IEC 60601 TEST LEVEL	COMPLIANCE LEVEL	ELECTROMAGNETIC ENVIRONMENT—GUIDANCE
Electrostatic discharge (ESD) IEC 61000-4-2	± 8 kV contact ± 15 kV air	In compliance	Floors should be wood, concrete, or ceramic tile. If floors are covered with synthetic material, the relative humidity should be at least 30%.
Electrical fast transient/burst IEC 61000-4-4	± 2 kV for power supply lines 100 kHz repetition frequency	Not applicable	Mains power quality should be that of a typical commercial or hospital environment.
Surge IEC 61000-4-5	± 1 kV line(s) to line(s) ± 2 kV line(s) to earth	Not applicable	Mains power quality should be that of a typical commercial or hospital environment.
Voltage dips, short interruptions and voltage variations on power supply input lines IEC 61000-4-11	0% U <sub>T</sub> ; 0.5 cycle At 0°, 45°, 90°, 135°, 180°, 225°, 270°, and 315° 0% U <sub>T</sub> ; 1 cycle and 70% U <sub>T</sub> ; 25/30 cycles Single Phase: at 0°	Not applicable	Mains power quality should be that of a typical commercial or hospital environment. If the user of the system requires continued operation during power mains interruptions, it is recommended that the system be powered from an uninterruptible power supply or a battery.
Rated power frequency magnetic fields IEC 61000-4-8	30 A/m Frequency: 50/60 Hz	In compliance	Power frequency magnetic fields should be at levels characteristic of a typical location in a typical commercial or hospital environment.
Conducted RF IEC 61000-4-6	3 V <sub>rms</sub> 150 kHz to 80 MHz 6 V <sub>rms</sub> in ISM bands 150 kHz to 80 MHz 80% AM at 1 kHz	In compliance	Portable and mobile RF communications equipment should be used no closer to any part of the system, including cables, than the recommended separation distance calculated from the equation applicable to the frequency of the transmitter.  <b>Recommended separation distance d (m)</b> $d=1.2 \sqrt{P}$

Table 23. Guidance and Manufacturer’s Declaration—Electromagnetic Immunity

The system is intended for use in the electromagnetic environment specified below. The customer or the user of the system should ensure that it is used in such an environment.

IMMUNITY TESTS	IEC 60601 TEST LEVEL	COMPLIANCE LEVEL	ELECTROMAGNETIC ENVIRONMENT – GUIDANCE
Radiated RF IEC 61000-4-3	3 V/m 80 MHz to 2.7 GHz 80% AM at 1 kHz	In compliance	$d=1.2 \sqrt{P}$ 80 MHz to 800 MHz $d=2.3 \sqrt{P}$ 800 MHz to 2.5 GHz where $P$ is the maximum output power rating of the transmitter in watts ( $W$ ) according to the transmitter manufacturer and $d$ is the recommended separation distance in meters (m). Field strengths from fixed RF transmitters, as determined by an electromagnetic site survey, <sup>a</sup> should be less than the compliance level in each frequency range. <sup>b</sup> Interference may occur in the vicinity of equipment marked with the following symbol: 

Note:  $U_T$  is the AC mains voltage prior to application of the test level.

At 80 MHz and 800 MHz, the higher frequency range applies.

These guidelines may not apply in all situations. Electromagnetic propagation is affected by absorption and reflection from structures, objects and people.

- a. Field strengths from fixed transmitters, such as base stations for radio (cellular/cordless) telephones and land mobile radios, amateur radio, AM and FM radio broadcast and TV broadcast cannot be predicted theoretically with accuracy. To assess the electromagnetic environment due to fixed RF transmitters, an electromagnetic site survey should be considered. If the measured field strength in the location in which the system is used exceeds the applicable RF compliance level above, the system should be observed to verify normal operation. If abnormal performance is observed, additional measures may be necessary, such as re-orienting or relocating the system.
- b. Over the frequency range 150 kHz to 80 MHz, field strengths should be less than 3 V/m.

## RECOMMENDED SEPARATION DISTANCES

Table 24. Recommended Separation Distances between Portable and Mobile RF Communications Equipment and the System

The system is intended for use in an electromagnetic environment in which radiated RF disturbances are controlled. The customer or the user of the system can help prevent electromagnetic interference by maintaining a minimum distance between portable and mobile RF communications equipment (transmitters) and the system as recommended below, according to the maximum output power of the communications equipment.

RATED MAXIMUM OUTPUT POWER OF TRANSMITTER (W)	SEPARATION DISTANCE ACCORDING TO FREQUENCY OF TRANSMITTER (m)		
	150 kHz to 80 MHz $d=1.2 \sqrt{P}$	80 MHz to 800 MHz $d=1.2 \sqrt{P}$	800 MHz to 2.5 GHz $d=2.3 \sqrt{P}$
0.01	0.12	0.12	0.23
0.1	0.38	0.38	0.73
1	1.2	1.2	2.3
10	3.8	3.8	7.3
100	12	12	23

For transmitters rated at a maximum output power not listed above, the recommended separation distance  $d$  in meters (m) can be estimated using the equation applicable to the frequency of the transmitter, where  $P$  is the maximum output power rating of the transmitter in watts (W) according to the transmitter manufacturer.

*Note: At 80 MHz and 800 MHz, the separation distance for the higher frequency range applies.*

*These guidelines may not apply in all situations. Electromagnetic propagation is affected by absorption and reflection from structures, objects, and people.*

# GLOSSARY

The following table provides definitions for specialized terms used in this manual or on the product itself. For a full list of caution, warning, and informational symbols used on this and other Verathon products, please refer to the *Verathon Symbol Glossary* at [verathon.com/service-and-support/symbols](http://verathon.com/service-and-support/symbols).

TERM	DEFINITION
A	Ampere
$A_{APRT}$	Active aperture area
Ah	Ampere hour
ALARA	As low as reasonably achievable
B-mode	Display mode showing the target of a current or saved scan as an ultrasound image.
C	Celsius
C-mode	Display mode showing the target of a current or saved scan as crosshairs over an area of color.
cm	Centimeter
DC	Direct current
EDS	Entrance dimensions of the scan
EMC	Electromagnetic compatibility
EMI	Electromagnetic interference
Essential performance	The system performance necessary to achieve freedom from unacceptable risk
ESD	Electrostatic discharge
F	Fahrenheit
$f_{awf}$	Acoustic working frequency (definition 3.4, IEC 62359:2010)
$f_c$	Center frequency
FDA	Food and Drug Administration (federal agency in U.S.)
g	Gram
GHz	Gigahertz
hPa	Hectopascal
Hz	Hertz
IEC	International Electrotechnical Commission
in	Inch
kHz	Kilohertz
$I_{sppa}$	Spatial-peak, pulse-average intensity
$I_{spta}$	Spatial-peak, temporal-average intensity
m	Meter
MHz	Megahertz
MI	Mechanical index
mL	Milliliter



TERM	DEFINITION
mm	Millimeter
MPa	Megapascal
mW	Milliwatt
μsec	Microsecond
OCP	Over current protection
OVP	Automatic over voltage protection
$P_o$	Ultrasonic power
PD	Pulse duration
$P_{r,3}$	Derated peak rarefactional pressure
PRF	Pulse repetition frequency
RF	Radio frequency
SCP	Short circuit protection
TI	Thermal index (definition 3.56, IEC 62359:2010)
TIB	Bone thermal index (definition 3.17, IEC 62359:2010)
TIC	Cranial bone thermal index (definition 3.21, IEC 62359:2010)
TIS	Soft tissue thermal index (definition 3.52, IEC 62359:2010)
UTI	Urinary tract infection
V	Volt
W	Watt
Wh	Watt hour
WEEE	Waste Electrical and Electronic Equipment
$Z_{sp}$	Axial distance at which the reported parameter is measured





