



GlideScope® Core™

Operations & Maintenance Manual

GlideScope
verathon

GlideScope Core

Operations & Maintenance Manual

Effective: August 2, 2023

Caution: Federal (United States) law restricts this device to sale by or on the order of a physician.

Contact Information

To obtain additional information regarding your GlideScope system, please contact Verathon Customer Care or visit [verathon.com/service-and-support](https://www.verathon.com/service-and-support).

Verathon Inc.

20001 North Creek Parkway
Bothell, WA 98011 U.S.A.
Tel: +1 800 331 2313 (US and Canada only)
Tel: +1 425 867 1348
Fax: +1 425 883 2896
[verathon.com](https://www.verathon.com)



Verathon Medical (Canada) ULC

2227 Douglas Road
Burnaby, BC V5C 5A9
Canada
Tel: +1 604 439 3009
Fax: +1 604 439 3039

EC REP



Verathon Medical (Europe) B.V.

Willem Fenengastraat 13
1096 BL Amsterdam
The Netherlands
Tel: +31 (0) 20 210 30 91
Fax : +31 (0) 20 210 30 92

Verathon Medical (Australia) Pty Limited

Unit 9, 39 Herbert Street
St Leonards NSW 2065
Australia
Within Australia: 1800 613 603 Tel / 1800 657 970 Fax
International: +61 2 9431 2000 Tel /
+61 2 9475 1201 Fax

CH REP

MDSS CH GmbH

Laurenzenvorstadt 61
5000 Aarau
Switzerland



Anandic Medical Systems AG

Stadtweg 24
8245 Feuerthalen
Switzerland



Copyright © 2023 by Verathon Inc. All rights reserved. No part of this manual may be copied or transmitted by any method without the express written consent of Verathon Inc.

GlideScope, GlideScope BFlex, GlideScope Core, GVL, GlideRite, QuickConnect, MagnaView, Spectrum, Verathon, and all associated symbols are trademarks or registered trademarks of Verathon Inc. All other brand and product names are trademarks or registered trademarks of their respective owners.

Not all Verathon Inc. products shown or described in this manual are available for commercial sale in all countries.

Information in this manual may change at any time without notice. For the most up-to-date information, see the documentation available at [verathon.com/service-and-support](https://www.verathon.com/service-and-support).

Table of Contents

IMPORTANT INFORMATION	1
Product Information	1
Product Description	1
Kasutusotstarve	1
Retsepti otstarve	1
Environments of Intended Use	1
Essential Performance	1
HIPAA Privacy	1
Notice to All Users	2
Hoiatused ja ettevaatusabinõud	2
INTRODUCTION	6
GlideScope Core	6
System Parts & Accessories	7
Buttons, Icons, & Connections	9
SYSTEM FEATURES	15
Home Screen	15
Gallery	16
SETTING UP	17
<i>Procedure 1. Perform Initial Inspection</i>	17
<i>Procedure 2. Mount the System (Optional)</i>	18
<i>Procedure 3. Charge the Monitor Battery</i>	21
<i>Procedure 4. Complete the Setup Wizard (Optional)</i>	22
<i>Procedure 5. Configure User Settings (Optional)</i>	25
<i>Procedure 6. Attach the Video Cable and Scope</i>	29
<i>Procedure 7. Attach the USB Device (Optional)</i>	31
<i>Procedure 8. Connect to an External Monitor (Optional)</i>	32
<i>Procedure 9. Perform a Functional Check</i>	33

USING THE DEVICE	34
<i>Procedure 1. Prepare the System.....</i>	34
<i>Procedure 2. Use a USB Pulse Oximeter.....</i>	35
<i>Procedure 3. Adjust Video Layout.....</i>	36
<i>Procedure 4. Rotate the Display</i>	37
<i>Procedure 5. Record Video or Take a Snapshot.....</i>	37
<i>Procedure 6. Use the Gallery.....</i>	38
REPROCESSING	43
MAINTENANCE & SAFETY	44
Periodic Inspections	44
GlideScope Core Battery	44
System Software	44
Device Repair.....	45
Device Disposal.....	45
LIMITED WARRANTY.....	46
PRODUCT SPECIFICATIONS	48
Component Specifications	48
GLOSSARY	57

Important Information

Product Information

GlideScope Core monitors provide the ability to attach a wide range of accessories, allowing for innovative system configurations. With two input connections, the system allows users to switch between different scopes without needing to disconnect and reconnect, or to have two different instruments connected for use simultaneously with picture-in-picture (Core 10) or Dual View (Core 15) options.

Product Description

GlideScope Core is an all-in-one system offering immediate access to the tools you need to visualize the airway. Designed around a 10" or 15" high-definition, touchscreen monitor and comprehensive workstation, GlideScope Core delivers elevated visibility and improved workflow.

For more information on compatible scopes, please see the *GlideScope Video Laryngoscopes Operations & Maintenance Manual* (part number 0900-4940) and the *GlideScope BFlex Single-Use Bronchoscopes Operations & Maintenance Manual* (part number 0900-4939), which are available at verathon.com/service-and-support.

Kasutusotstarve

Monitorid ja tööjaamad on mõeldud töötamiseks videoendoskoopidega koos teiste lisaseadmetega hingamistees endoskoopia tegemiseks.

Retsepti otstarve

Ettevaatust: Föderaalseadused (Ameerika Ühendriigid) lubavad seda seadet müüa ainult arstil või arsti ettekirjutusel.

Süsteemi tohivad kasutada ainult isikud, kelle on välja õpetanud ja keda on volitanud arst, või tervishoiuteenuse osutajad, kelle on välja õpetanud ja keda on volitanud raviautus.

Environments of Intended Use

The GlideScope Core system is intended to be used in a Professional Healthcare Environment.

Essential Performance

When connected to compatible camera units (such as video laryngoscopes and bronchoscopes), the essential performance of the monitor is to support the display of a clear, unobstructed view of the airway and tracheobronchial tree for medical procedures.

HIPAA Privacy

The Health Insurance Portability and Accountability Act of 1996 ("HIPAA") regulations require our customers to monitor and limit the ways in which patients' confidential information is accessed, utilized, stored, transmitted, and disposed. Our customers are ultimately responsible for ensuring all electronic health information contained within the system is protected. In the course of providing the services to customers, Verathon will remove all electronic protected health information from the system if present.

Notice to All Users

Verathon recommends that all users read this manual before using the system. Failure to do so may result in injury to the patient, may compromise the performance of the system, and may void the system warranty. Verathon recommends that new users:

- Obtain instruction from a qualified individual
- Practice using video laryngoscopes on a mannequin before clinical use
- Acquire clinical training experience on patients without airway abnormalities

Hoiatused ja ettevaatusabinõud

Hoiatused viitavad, et seadme kasutamine või väärkasutamine võib tekitada vigastusi, surma või muid tõsisid kõrvaltoimeid. *Ettevaatusabinõud* viitavad, et seadme kasutamine või valesti kasutamine võib tekitada probleeme, nt talitlushäireid, rikkeid või toote kahjustusi. Pöörake kogu kasutusjuhendis tähelepanu jaotistele pealkirjaga *Oluline*, mis sisaldavad järgmiste ettevaatusabinõude meeldetuletusi või kokkuvõtteid, kuna need kehtivad konkreetse komponendi või kasutusolukorra puhul. Pöörake tähelepanu järgmistele hoiatustele ja ettevaatusabinõudele.

Hoiatused: Kasutamine



HOIATUS

Enne iga kasutuskorda veenduge, et seade töötaks õigesti ja sellel ei oleks kahjustusi. Ärge kasutage seda toodet, kui seade näib kahjustatud olevat. Pöörduge hooldustööde tegemiseks kvalifitseeritud töötajate poole.

Veenduge alati, et alternatiivsed hingamisteede juhtimise meetodid ja seadmed oleksid käepärast.

Teavitage Verathoni klienditeenindust kõigist oletatavatest vigadest. Vaadake kontaktteavet veebilehelt verathon.com/service-and-support.



HOIATUS

Kaasaskantavaid raadiosideseadmeid (sh välisseadmeid, nt antennikaableid ja välisantenne) ei tohi kasutada kuni 30 cm (12 tolli) kaugusel süsteemi GlideScope Core mistahes osast, k.a kaablitest, mille Verathon on määranud või mida Verathon pakub kasutamiseks selle süsteemiga. Kui vahekaugust ei hoita, võib süsteemi jõudlus halveneda ja kujutise kuvamine häiruda.



HOIATUS

Verathon ei ole analüüsinud süsteemi sobivust keskkondadega, kuhu on paigaldatud magnetresonantstomograafia seadmed. Seetõttu peab süsteemi omanik vältima seadme sattumist magnetresonantskeskkonda.



HOIATUS

Kasutage ainult passiivset mä lupulka. Ärge kasutage mä lupulki, mis saavad toidet teisest välisallikast.

Hoiatused: Töötlemine



HOIATUS

Kuna toode võib saastuda inimese vere või kehavedelikega, mille kaudu võivad levida patogeenid, peavad kõik puhastusseadmed olema kooskõlas Ameerika Ühendriikide standardiga OSHA Standard 29 CFR 1910.1030 „Vere kaudu levivad patogeenid“ või võrdväärse standardiga.



HOIATUS

Seda toodet tohib puhastada ainult GlideScope'i ja GlideRite'i toodete töötlemisjuhendis (osa number 0900-5032) esitatud heakskiidetud menetlustega. Verathon soovib loetletud puhastusmeetodeid tõhususe või komponentide materjalidega sobivuse alusel.

Hoiatused: Tooteohutus



HOIATUS

See vahend ja seotud seadmed võivad sisaldada akusid ja muid keskkonnaohtlikke materjale. Kui vahendi või tarvikute kasutamisega on lõppenud, vt seadme kõrvaldamise jaotist. Käidelge kasutatud ühekordselt kasutatavaid komponente nakkusohtlike jäätmetena.



HOIATUS

Elektrilöögiohu vähendamiseks kasutage ainult Verathon soovitatud tarvikuid ja välisseadmeid.



HOIATUS

Süsteemi elektriohutuse tagamiseks peavad välised monitorid olema sertifitseeritud standardite IEC 60601-1, IEC 60950-1 või samaväärsete standardite alusel.



HOIATUS

Elektriohutuse tagamiseks kasutage ainult kaasasolevat toiteallikat. Ühendage toitejuhe ja toiteadapter õigesti maandatud pistikupessa ning veenduge, et see oleks lahtiühendamiseks hõlpsasti ligipääsetav. Kasutage ainult Verathoni soovitatud tarvikuid ja välisseadmeid.



HOIATUS

Elektrilöögi oht. Ärge püüdke süsteemi komponente avada. Avamine võib kasutajat raskelt vigastada või kahjustada seadet ja tühistada garantii. Kõikide hooldusvajaduste korral võtke ühendust Verathoni klienditeenindusega.



HOIATUS

Talletunud mehaanilise energia oht. Tööjaama Premium varremehhanism on pinges all. Kui monitor eemaldatakse, võib vars iseseisvalt kiiresti üles liikuda. Enne monitori eemaldamist veenduge, et vars oleks kõrgeimas asendis.



HOIATUS

Muude kui Verathoni määratud või tarnitud tarvikute ja kaablite kasutamine võib põhjustada süsteemis elektromagnetilisi rikkeid, sh suurendada kiirgumist või vähendada häirekindlust. See võib põhjustada seadme talitlushäireid, protseduuri viivitusi või mõlemat.



HOIATUS

Kui GlideScope Core'i tööjaam Premium on varustatud GlideScope Core'i 15-tollise monitoriga, võib tööjaam mõnes pikendatud asendis ümber kukkuda ja vigastusi põhjustada. Selle vältimiseks liigutage monitor enne süsteemi veeretamist kõige madalamasse ja kõige tagasitõmmatumasse asendisse.



HOIATUS

Seadme muutmise ei ole lubatud.



HOIATUS

Ärge kasutage toiteadapterit tuleohtlike anesteetikumide läheduses.

Ettevaatusabinõud



ETTEVAATUST

Elektriliste meditsiiniseadmete kasutamisel on vaja elektromagnetilise ühilduvuse (EMC) tagamiseks rakendada erilisi ettevaatusabinõusid ning need seadmed tuleb paigaldada ja neid tuleb kasutada selles juhendis esitatud juhiste järgi. Vaadake lisateavet elektromagnetilise ühilduvuse jaotisest.

Vältige süsteemi GlideScope kasutamist teiste seadmete kõrval või nendega virmastatuna. Kui külgnev või virmastatud kasutamine on vajalik, jälgige süsteemi, et kontrollida selle normaalset talitlust konfiguratsioonis, milles seda kasutatakse.

Seade võib kiirata raadiosagedusenergiat ja väga tõenäoliselt ei tekita see kahjulikke raadiohäireid teistele läheduses asuvatele seadmetele. Ei ole tagatud, et konkreetset konfiguratsioonis häireid ei esine. Häirete esinemise ilminguks võib muu hulgas olla selle seadme või teiste seadmete talitluse halvenemine, kui seadmeid kasutatakse samal ajal. Kui see juhtub, proovige häired kõrvaldada ja taastada optimaalne pildikvaliteet, kasutades järgmisi meetmeid.

- Lülitage läheduses asuvaid seadmeid sisse ja välja, et teha kindlaks häire allikas.
- Muutke selle seadme või muude seadmete suunda või asukohta.
- Suurendage seadmete vahekaugust.
- Ühendage seade pistikupessa, mis on teises vooluahelas kui teine seade (teised seadmed).
- Kõrvaldage elektromagnethäire (EMI) või vähendage seda tehniliste lahendustega (nt varjestamisega).
- Ostke meditsiiniseadmed, mis vastavad standardi IEC 60601-1-2 EMC nõuetele.

Pidage meeles, et kaasaskantavad ja mobiilsed raadiosideseadmed (mobiiltelefonid jne) võivad mõjutada elektrilisi meditsiiniseadmeid. Rakendage töö ajal vajalikke ettevaatusabinõusid.



ETTEVAATUST

Süsteem sisaldab elektroonilisi osi, mida ultraheliseade ja automaatne pesur võivad kahjustada. Ärge kasutage toote puhastamiseks ultraheliseadet ega automaatset pesurit, mida Verathon ei ole heaks kiitnud.



ETTEVAATUST

Veenduge, et te ei kasutaks videomonitori ekraani puhastamisel abrasiivseid harju, patju ega tööriistu. Sellega võite ekraani kriimustada ja seadet jäädavalt kahjustada.

Introduction

GlideScope Core

The monitor is compatible with the following single-use and reusable endoscopic devices, which this manual refers to as *scopes*:

- Spectrum Single-Use blades
- Titanium Reusable blades
- Video Baton and Stats
- BFlex Single-Use Bronchoscopes

The monitor uses scopes and connecting cables, along with optional system components to help facilitate intubations, endoscopy, or provide convenience to the user.

You may use either single-use or reusable components, or your facility may elect to provide both. This manual details how to use the monitor and provides limited information on how to connect scopes. For more information on compatible scopes, refer to the following manuals or contact Verathon Customer Care:

- *GlideScope Video Laryngoscopes Operations & Maintenance Manual* (part number 0900-4940)
- *GlideScope BFlex Single-Use Bronchoscopes Operations & Maintenance Manual* (part number 0900-4939)

Current editions of these manuals are available at [verathon.com/service-and-support](https://www.verathon.com/service-and-support).

In this document, unless otherwise noted, the term *video cable* describes all possible cable configurations for reusable blades, single-use blades, and video baton. The term *scope* describes all possible laryngoscope and bronchoscope configurations.

Single-Use Options

Spectrum single-use video laryngoscopes are identified by an *S* in the blade name (for example, *LoPro S4*), connect to the Core monitor via a reusable video cable, and are available in an extensive range of blade sizes and types to enable intubation across a wide range of patient types and clinical settings.

Reusable Video Batons fit into single-use GVL Stats and connect to the Core monitor through a reusable video cable.

All GlideScope BFlex single-use bronchoscopes are single-use components.











When the procedure is complete, all single-use components must be disposed of according to your local protocols for biohazard waste.

Reusable Options

Titanium video laryngoscopes must be cleaned and high-level disinfected between uses. These connect to the video monitor through the reusable GlideScope Core Video Cable. Due to their titanium construction, reusable video laryngoscopes contain a *T* in the blade name, such as *LoPro T4*.

System Parts & Accessories

Table 1. Required System Components

REQUIRED PARTS & ACCESSORIES		
GlideScope Core video monitor		
GlideScope Core 10 	GlideScope Core 10 FHD 	
GlideScope Core 15 	GlideScope Core 15 FHD 	
12V DC power adapter 	Power cable 	Video cable** 
One or more of the following scope styles:		
Single-Use Blades† 	Video Batons and Single-Use Stats† 	Titanium Reusable Blades† 

* Cables shortened for illustration purposes

† For a full list of compatible cables and video scopes, please see the *GlideScope Video Laryngoscopes Operations & Maintenance Manual* (part number 0900-4940)

REQUIRED PARTS & ACCESSORIES

BFlex Single-Use Bronchoscopes*



Table 2. Optional System Components

OPTIONAL PARTS & ACCESSORIES

<p>Premium workstation (0800-0557)</p>		<p>Premium workstation (0800-0636)</p>	
<p>Nonin 3231 USB External Pulse Oximeter†</p>	<p>GlideRite Stylets‡</p>	<p>Media storage USB</p>	<p>Operations & Maintenance Manual USB</p>

* For a full list of single-use bronchoscopes, please see the *GlideScope BFlex Single-Use Bronchoscopes Operations & Maintenance Manual* (part number 0900-4939) or *BFlex 2 Single-Use Bronchoscopes Operations & Maintenance Manual* (part number 0900-5209).

† Not available in all markets

‡ For a full list of compatible stylets, please see the *GlideRite DLT Stylet Operations & Maintenance Manual* (part number 0900-4841) and the *GlideRite Rigid Stylet Operations & Maintenance Manual* (part number 0900-4686).















Buttons, Icons, & Connections

















































The digital, full-color GlideScope Core Video Monitor clearly displays the images transmitted from the camera in the scope. The front of the monitor includes the button for power and the touchscreen.













The back panel of the monitor includes sockets and ports for connecting the power cord, video cables, USB flash drives, and an HDMI cable for an external video display. When the USB and HDMI ports are not in use, it is recommended that the rubber cover be used to protect the openings from dust and other contamination. The back of the monitor also features VESA mounting holes that allow you to attach the monitor to a GlideScope Core workstation.

The following tables provide general information regarding the buttons and icons on the monitor.

Table 3. Monitor Buttons

BUTTON GROUP	BUTTON	FUNCTION
Front panel		Power: This is a physical button located on the bottom left corner of the display. Press and release to turn on the monitor. Press and hold to turn it off. <i>Note: If the monitor locks up or becomes unresponsive for any reason, press and hold the Power button for 7 seconds to turn off the system.</i>
Home screen (left side)—media buttons and main menu		Record (toggle): Records all visible video feeds. While recording, and depending on the recording status and mode, the record button's icon will change to one of the following:  Video is recording. Press to end recording.  Video is recording with audio. Press to end recording.  Video recording error.  Video with audio recording error.
		Snapshot button: Takes a photo of the video feed(s). If there is an error, the icon changes to include an Attention symbol: 
		Note editor button: Launches Note Editor. If there is an error, the icon changes to include an Attention symbol: 
		Main Menu: Reveals the Main Menu flyout containing the Gallery and Settings buttons, and when enabled the Video Rotation.
Status bar		Favorites filter: Toggles the favorites filter. When the filter is turned on, the star and toggle will change from gray to gold.
		Sort by date (Gallery): Select the up arrow  for ascending order or down arrow for descending  order.

BUTTON GROUP	BUTTON	FUNCTION																
Main Menu Flyout		Gallery: Launches Gallery page. If there is an error, the icon changes to include an Attention symbol: 																
		Settings: Launches Settings page.																
		Video Rotation: Pressing this button rotates video feed(s) 180-degrees. Can be enabled or disabled in the Feature Settings Tab .																
Settings menu		Features: Displays the Feature Settings page.																
		Regional Settings: Displays the Regional Settings page.																
		Administrative Settings: Displays the Admin Settings page.																
Toggle switches		Switch in the off position.																
		Switch in the on position. <i>Note: If the toggle switch enables the Video Rotation option, it turns gold.</i>																
Home screen (right side)— Video layout menus		Video Layout Menu: Opens the Video Layout menu. The menu contains several selectable layout configurations. The button changes to match the following layouts. <table border="1" data-bbox="507 1041 1495 1167"> <thead> <tr> <th colspan="4">Core 10</th> <th colspan="4">Core 15</th> </tr> </thead> <tbody> <tr> <td></td> <td></td> <td></td> <td></td> <td></td> <td></td> <td></td> <td></td> </tr> </tbody> </table>	Core 10				Core 15											
	Core 10				Core 15													
																		
		Video Feed button and Icon: Displays the video feed channel (A or B) and connected scope. The following are a few examples:     																
		Move Left: Moves the video window to the left side.																
		Move Right: Moves the video window to the right side.																
		Close: Closes the video window, dialog, or editor.																
		Brightness: Opens and closes the brightness controls. 																
	Contrast: Opens and closes the contrast controls. 																	
	Dynamic Light Control: Displays the Dynamic Light Control status for compatible video laryngoscopes attached to the monitor. The default setting for Dynamic Light Control can be set in the Feature Settings Tab .																	

BUTTON GROUP	BUTTON	FUNCTION
Gallery		Export: Exports selected file.
		Star: Adds or removes 'favorite' status to selected file.
		Delete: Deletes selected file.
		Back: Returns to previous screen.
		Select All: When viewing files in the Gallery, check this box to select all files in the row.
		Note Thumbnail: Indicates the file is a patient note. Tap to open the patient note viewer.
		Video Thumbnail: Indicates the file is a video. Select to open the video player.
		Expand: Expands the video to fill the screen.
		Standard View: Returns the video to its normal size.
Note editor		Save: Saves editor changes.
		Close: Closes editor.
Media Export		Copy: After tapping the Export button, select this option to copy the selected files to the USB drive. This leaves a copy in the internal memory.
		Move: After pressing the Export button, select this option to move the selected files to the USB drive. This removes the copy from the internal memory unless the file is marked as a favorite.

















BUTTON GROUP	BUTTON	FUNCTION
Gallery— video player		Restart: Rewinds selected video to beginning.
		Rewind: Rewinds selected video by 20% of the video's duration.
		Play Video: Plays selected video. Changes to pause button while video is playing.
		Pause Video: Pauses the playing video. Changes to play button while video is paused.
		Fast Forward: Skips selected video by 20% of the video's duration.
		Volume (toggle): Toggles volume buttons and meter.
		Volume Up: Turns the volume up.
		Volume Down: Turns the volume down.
		Mute: Mutes the volume. When muted, also un-mutes the volume.
		Playhead: Shows the current location in the video. Can be dragged horizontally to jump to a specific location in the video.

Table 4. On-Screen Icons

ICON	FUNCTION
	Battery Status: Indicates the remaining battery power. See Charge the Monitor Battery on page 21 for more information.
	Favorite: Displays above Gallery files that have been selected as favorites.
	Power-Down Countdown: The unit is about to turn off. If this is due to the Auto Shutdown feature, touch the screen to cancel the shutdown. <i>Note: The Auto Shutdown feature can be adjusted or disabled on the Feature Settings screen. For more information, see Complete the Setup Wizard (Optional) on page 22.</i>
	Storage—Internal Memory: Displays available internal memory.
	Storage—USB Drive: Displays available USB memory. Shows when a USB drive is attached.
	Attention: Indicates important text.



















ICON	FUNCTION
	USB Drive Detected: Indicates a USB flash drive is attached to the monitor and detected.
	Hourglass: Advises the operator to wait while the system shuts down.
	Patient name field: Indicates the patient name text entry field.
	Clinician name field: Indicates the clinician name text entry field.
	Device Name: Indicates the device name text entry field.
	Recording options: Indicates settings for video and audio recording.
	Video Rotate options: Indicates settings for video rotation.
	System Sounds: Indicates settings for system sounds.
	Time zone and daylight savings: Indicates settings for the time zone and daylight savings time.
	Security Code options: Indicates settings for system security code.
	Video Timestamps: Indicates settings for video timestamps.
	Snapshot Timestamps: Indicates settings for snapshot timestamps
	Date options: Indicates settings for the system date.
	Time Editor: Icon for the time editor.
	Charging indicator: Appears when the monitor is connected to the power adapter.
	Auto-Shutdown: Indicates settings for Auto-Shutdown.
	Pulse rate: Appears when an external pulse oximeter is connected to the monitor and receiving readings from the patient.
	Note Field options: Indicates settings for note fields.
	Reset Settings: Indicates option to reset system settings to factory default.

Figure 1. GlideScope Core Monitor Front Panel



Figure 2. GlideScope Core Monitor Back Panel

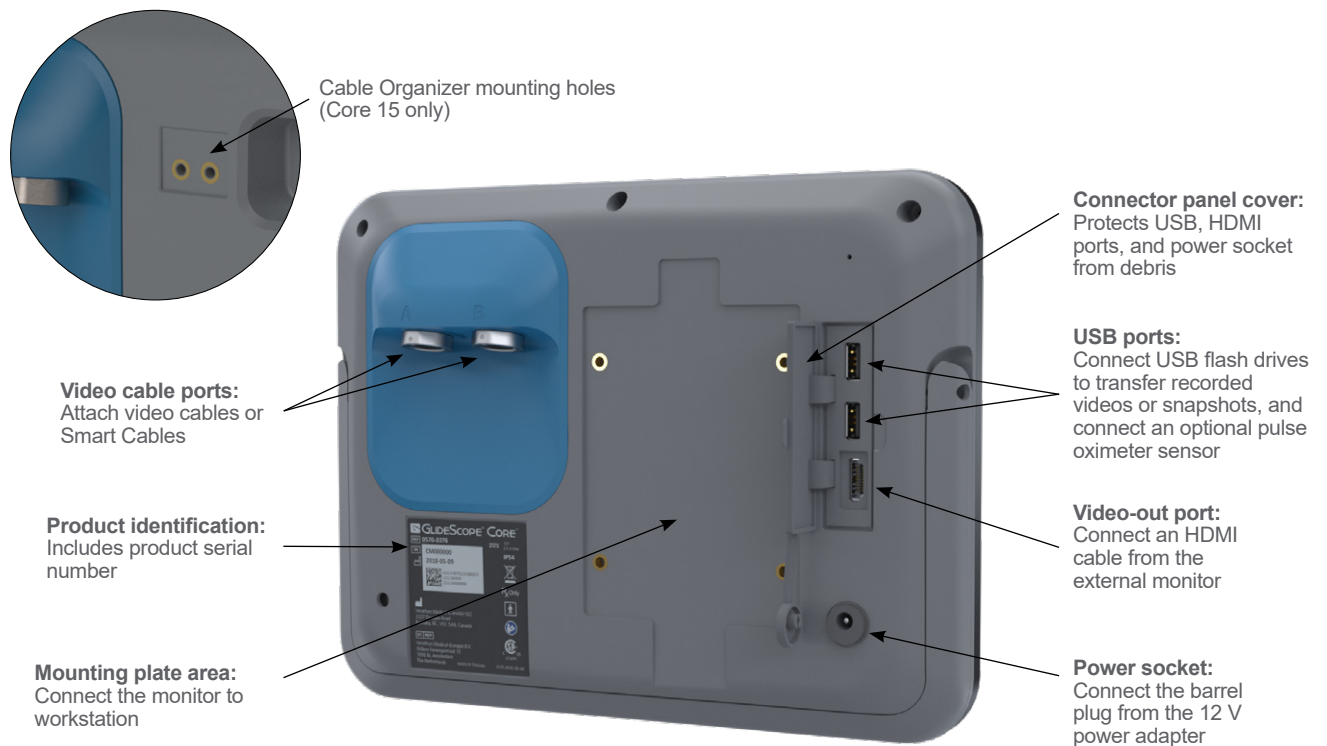

System Features

Home Screen

The Home screen* displays system information and provides access to several options and menus.

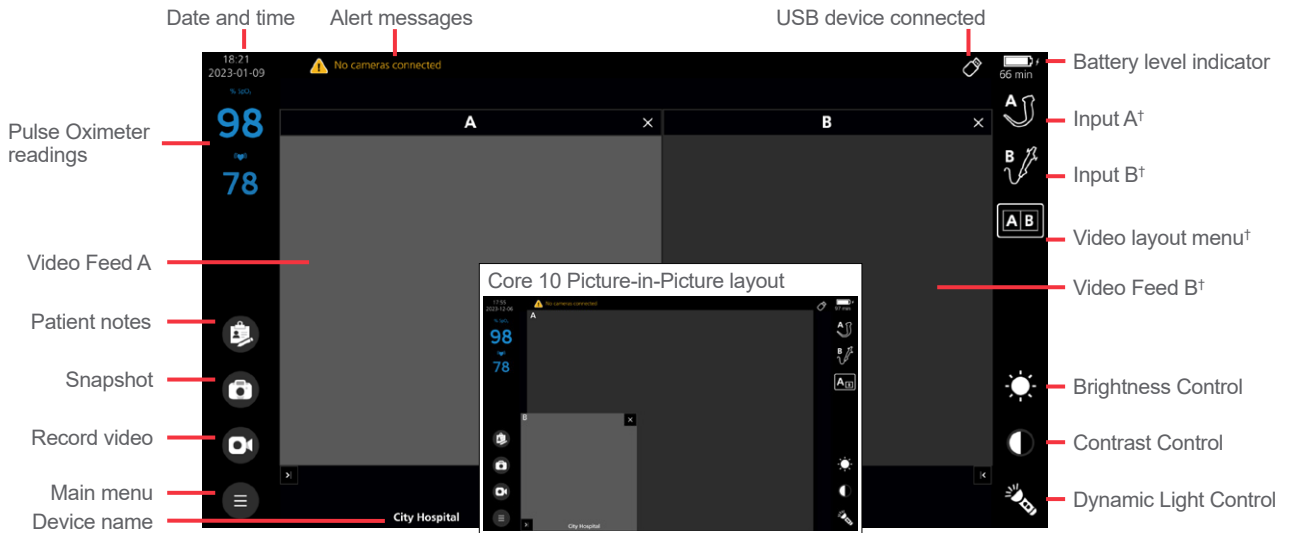

STATUS BAR

The Status Bar runs along the top of the display. It is shown at all times and can provide the following information depending on the current screen:

- Date and Time
- Alert messages
- Device name
- System or task status
- USB connection status
- Battery status and approximate time remaining
- Organization controls (Gallery)
- Favorites filter (Gallery)

LEFT BAR

The left bar provides access to the Main Menu, Patient Notes, and Snapshot buttons, and also the Record Video button when it is enabled in the Settings menu.

The monitor can also relay SpO₂ and pulse-rate readings when a Nonin 3231 USB External Pulse Oximeter is attached. The readings are displayed near the top of the bar.

Note: If a pulse oximeter is attached to the monitor and is not receiving information from a patient, two dashes (--) are shown instead of a reading.

IMPORTANT

The SpO₂ values displayed on the monitor can be used as a convenient secondary display. These are not intended for patient diagnosis. For direction on using the USB pulse oximeter, please refer to the Nonin instructions for use.

* GlideScope Core 15 Dual View layout pictured.

RIGHT BAR

The right bar displays an icon for connected scopes. When more than one scope is attached, the Video Layout menu is shown. For more information on video layout features, see [Adjust Video Layout](#) on page 36.

Buttons for Brightness Control and Contrast Control are available when they are enabled in the Settings menu.

VIDEO FEED

The main feature of the Home screen is the video feed. This displays the video transmitted from the attached scopes. When two scopes are attached, both video feeds can be viewed simultaneously. This area can also be mirrored to an external monitor through an HDMI connection.

Gallery

The Gallery allows you to view videos and snapshots that have been recorded and stored on the monitor. From the Gallery you can view patient notes, create favorites, and export files to a USB flash drive to use as a backup or to view on a computer. For information on using the Gallery, see [Use the Gallery](#) on page 38.

Figure 3. Main Gallery Screen

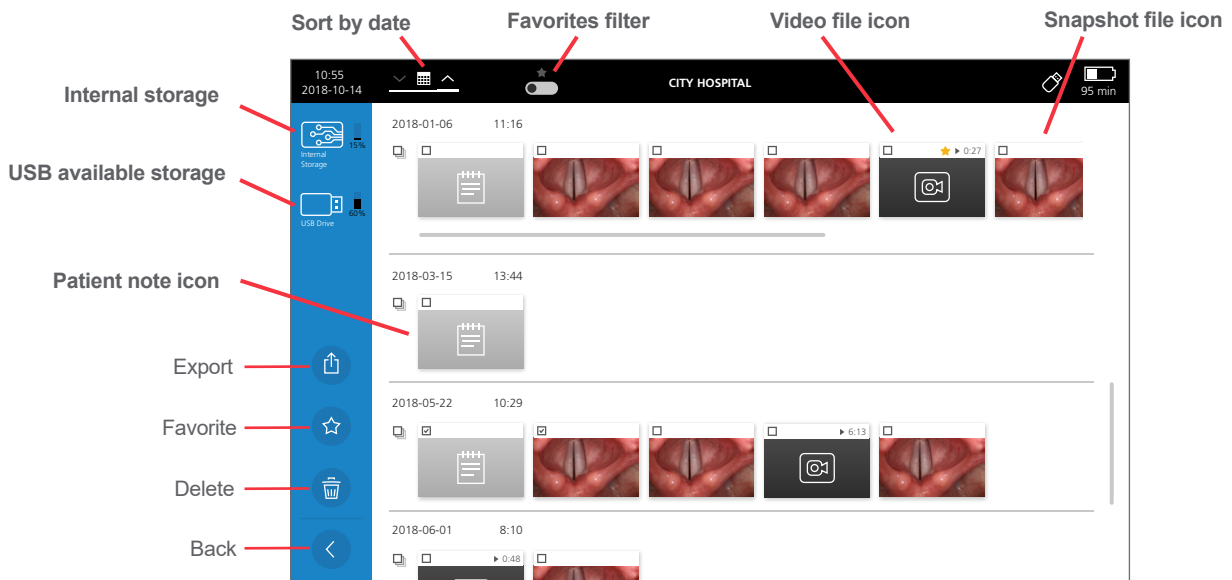

Setting Up



Please read the [Hoiatused ja ettevaatusabinõud](#) section before performing the following tasks.

IMPORTANT

If you choose to mount the Core 15 monitor on a Core workstation, it can be mounted only on part number 0800-0636.

Before you can use the system for the first time, you must inspect the components, set up the system, and perform a functional test as recommended by Verathon. Complete the following procedures:

1. **Perform Initial Inspection**—Inspect the system for any obvious physical damage that may have occurred during shipment.
2. **Mount the System (Optional)**—Set up the monitor on a mobile workstation.
3. **Charge the Monitor Battery**—You can use the system while the battery is charging.
4. **Attach the Video Cable and Scope**—Connect the appropriate video cable to the monitor, and then connect the scope to the video cable.
5. **Connect to an External Monitor (Optional)**—Connect the monitor to an external display source, such as a larger monitor screen, by using an HDMI cable.
6. **Complete the Setup Wizard (Optional)**—The Setup Wizard walks you through an initial system configuration with settings such as the date, time, and system security code.
7. **Configure User Settings (Optional)**—Enter data customized to your clinic, and configure settings such as the date, and time, video timestamps, and other administrative settings.
8. **Perform a Functional Check**—Before you use the device for the first time, perform a functional check to ensure that the system is working properly.

Procedure 1. Perform Initial Inspection

When you receive the system, Verathon recommends that an operator familiar with the instrument perform a full visual inspection of the system for any obvious physical damage that may have occurred during shipment.

1. Verify that you have received the appropriate components for your system by referring to the packing list included with the system.
2. Inspect the components for damage.
3. If any of the components are missing or damaged, notify the carrier and Verathon Customer Care or your local representative. For contact information, visit verathon.com/service-and-support.

Procedure 2. Mount the System (Optional)

If you choose to mount the system, the GlideScope Core Premium Workstation makes it easy for you to move the system from one location to another, and to adjust the monitor's position to fit your needs.

Figure 4. Premium Workstations



The workstation includes a cable organizer near the monitor mount. This fixture keeps cables attached to the monitor and easy to reach between uses.

Figure 5. Workstation Features

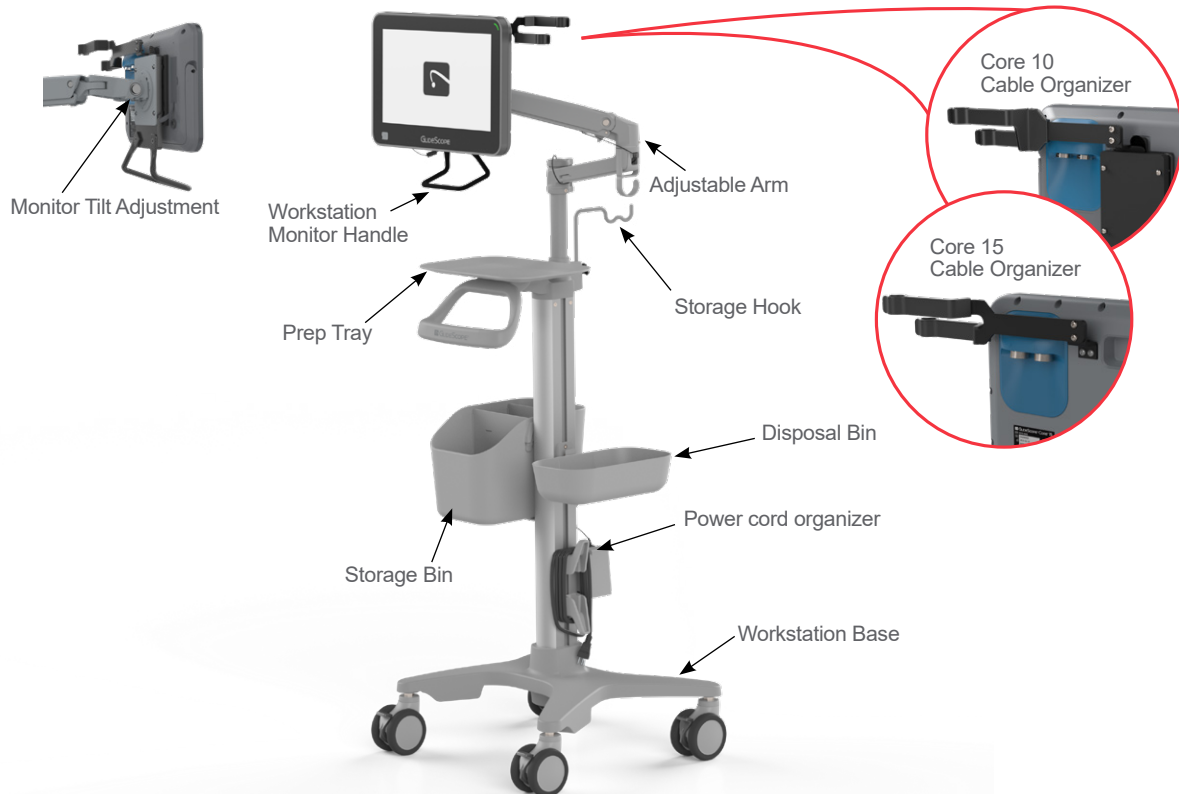

ATTACH THE MONITOR TO THE WORKSTATION

1. Assemble the workstation according to its included instructions.
2. When attaching the quick-release locking plate, ensure the (4) screws are fully tightened and the locking plate is securely attached to the monitor.

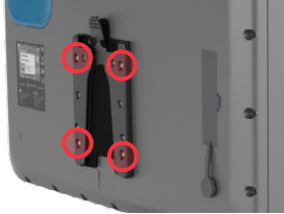

Note: The screws and hex driver are included with the workstation.

3. Slide the locking plate of the monitor onto the quick-release mount. When properly situated, the monitor sits securely on the mount and the quick-release locking tab locks into the quick-release mount.

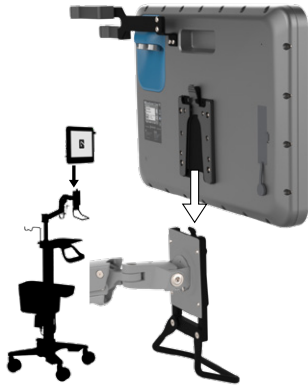

4. To remove the monitor, press the locking tab and lift the monitor off the mount.

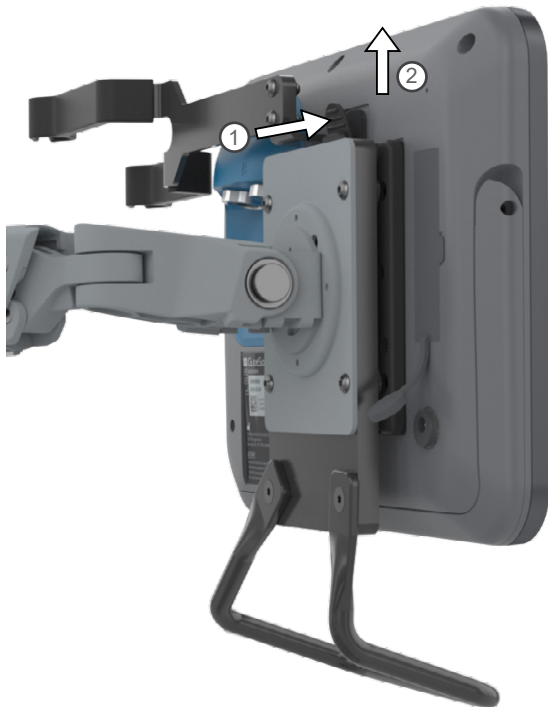

ADJUST THE MONITOR TILT ANGLE TENSION

If the angle of the monitor is difficult to adjust, or the monitor angle tilts down on its own, the workstation's monitor angle tension needs to be adjusted.

- Using a 4 mm hex wrench, turn the tension adjustment screw clockwise to increase the tension, or counter-clockwise to decrease it.

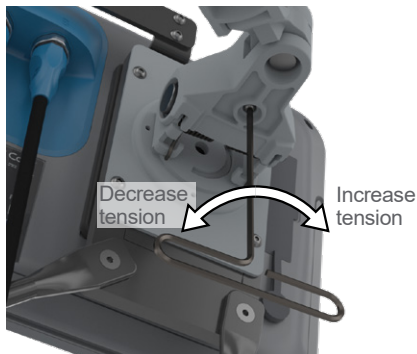

ADJUST THE PREMIUM WORKSTATION ARM STRENGTH

When using the Premium Workstation, depending on the combined weight of the monitor and mounted accessories, the strength of the articulating arm's lifting spring may need to be adjusted.

1. Lift the arm to its maximum height.

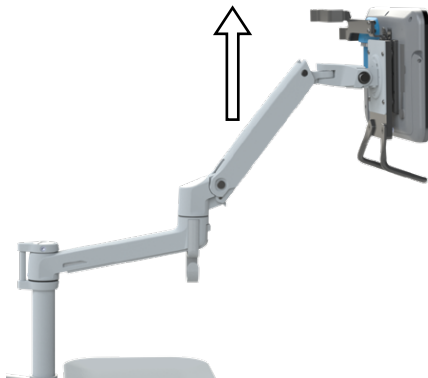

2. Using a 4 mm hex wrench, turn the spring adjustment screw clockwise to increase the arm's lifting strength, or counter-clockwise to decrease it. *The optimal adjustment will allow the arm to remain in position without lowering or raising on its own.*

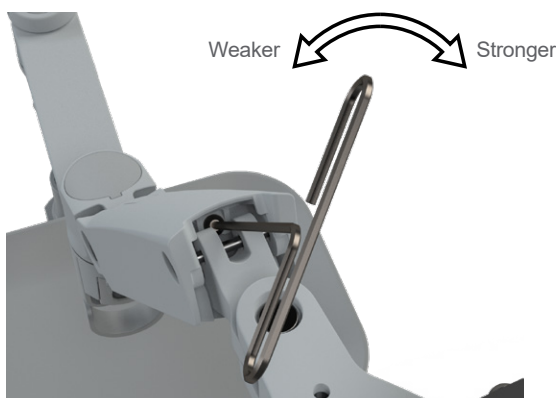

Procedure 3. Charge the Monitor Battery



Please read the [Hoiatused ja ettevaatusabinõud](#) section before performing the following task.

The GlideScope Core Monitor includes an internal lithium battery. Verathon recommends that you charge the battery fully prior to first use.

Under normal operating conditions, a fully charged battery lasts approximately 135 minutes for Core 10, and 90 minutes for Core 15 before it needs to be recharged. For optimal battery life, ensure that the battery is fully charged before you try to use the monitor in battery mode. You should charge the battery at temperatures from 10 to 35°C (50 to 95°F).

An estimate of the time remaining is shown under the battery icon. This time is based on the battery draw and may vary depending on the number of components and accessories attached. As the battery is depleted, the battery status bar will shrink, changing color at certain levels.

Figure 6. Battery Status Icons

 **Red battery bar***: Less than 10 minutes of battery life remaining. Battery must be charged.

 **Gold battery bar**: 10 to 30 minutes of battery life remaining.

 **White battery bar**: More than 30 minutes of battery life remaining.

1. Connect the video monitor 12V DC power adapter to the power cable.
2. On the back panel of the monitor, remove the power socket cap, and then connect the 12V DC power adapter to the power socket.





3. Plug the power supply into a hospital-grade power outlet.
4. Allow the battery to charge. Fully charging the battery may take up to 4 hours.

* With less than 10 minutes of battery life remaining, the Record button is hidden and the monitor will not allow video recording. If a video is already recording, the monitor will save it, and then stop recording.

Procedure 4. Complete the Setup Wizard (Optional)

The first time the monitor is powered on, a setup wizard guides you through some initial settings. If the setup wizard has already been completed, or you decide to skip the setup wizard, all settings can be modified in [Configure User Settings \(Optional\)](#) on page 25.

The setup wizard progress bar is shown on the left of the display. To go back to a previous setting, tap the **Back**  button. To exit the wizard, tap the **Close**  button.

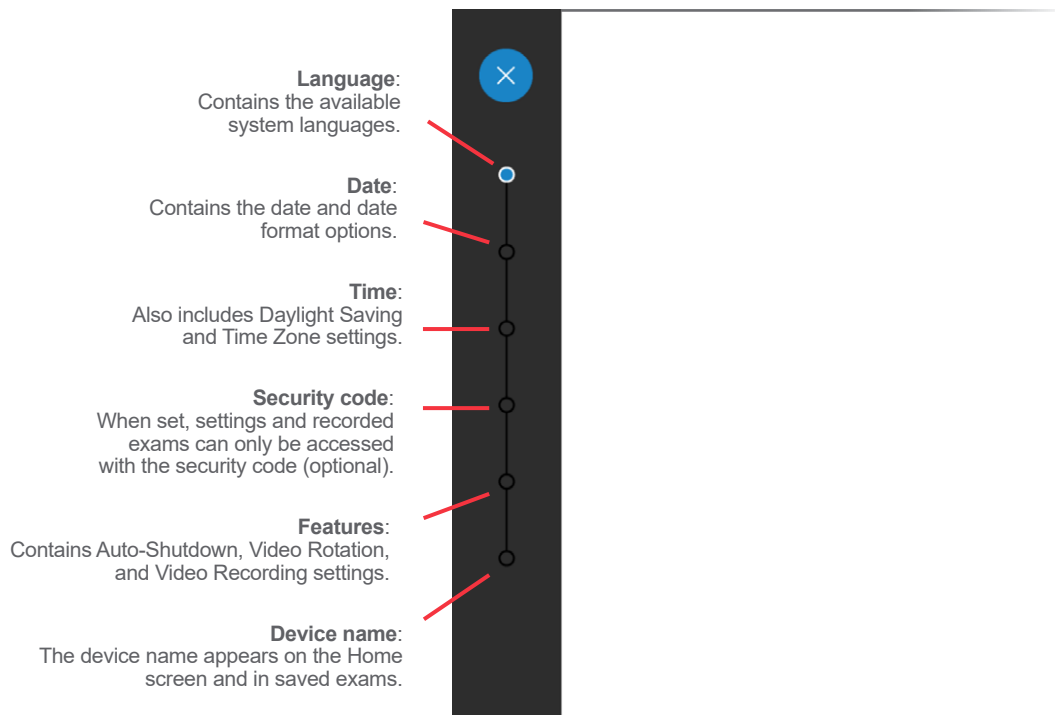

1. Select the system language, and then tap the check mark to continue.

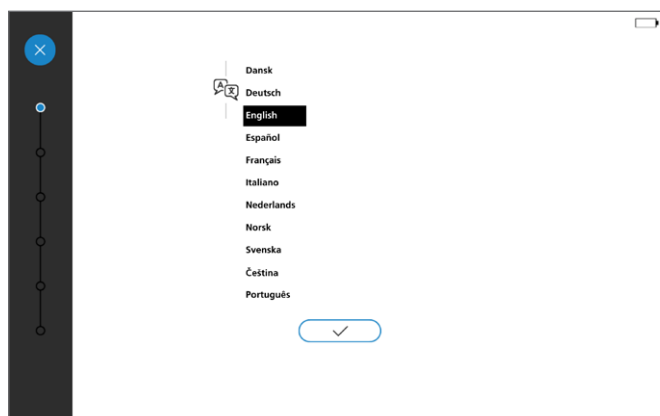

- Set the date and date format, and then tap the check mark to continue.

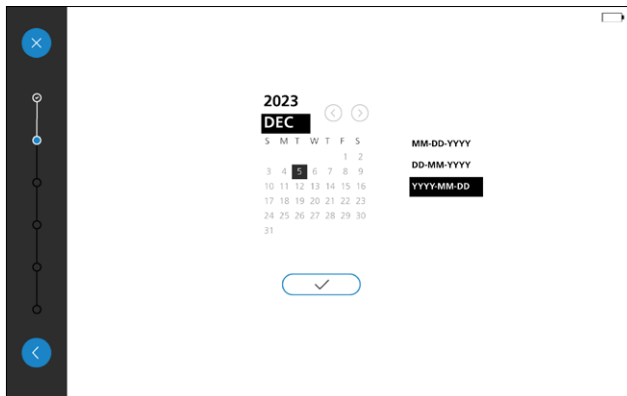

- Set the time, time zone, and the daylight saving preference, and then tap the check mark to continue.

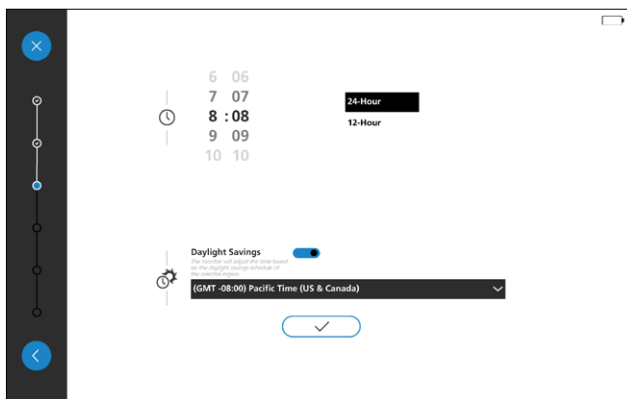

- If you would like to set a security code, enter the code, and then tap the check mark. Confirm the code by re-entering it, and then tap the check mark. If the code is confirmed, you will proceed to the next setting.*

If you do not want a security code, tap the Security Code toggle to **Off** , and then tap the check mark to proceed to the next setting.

Note: When a security code is enabled, users will require it to access the Gallery and system settings.

Figure 7. Security code on

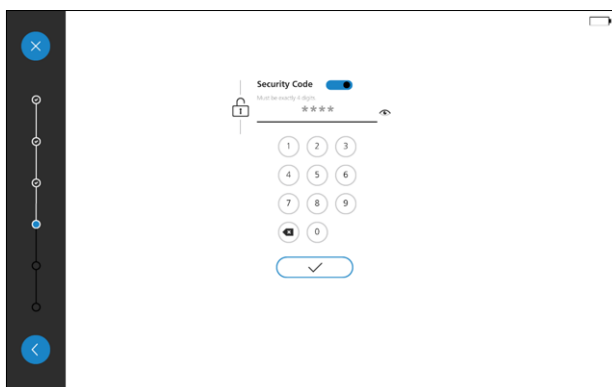
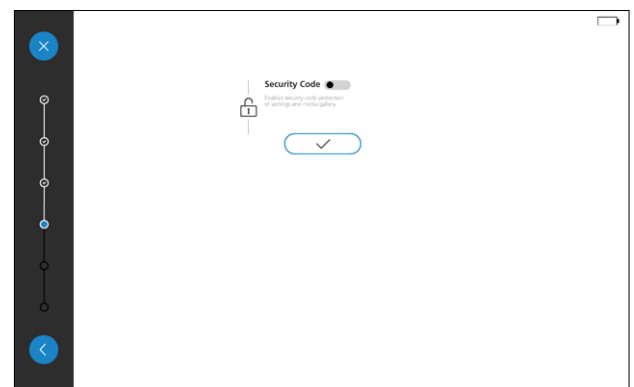



Figure 8. Security code off



* If the security code has been forgotten, please contact Verathon Customer Care. For contact information, visit verathon.com/service-and-support.

5. To enable or customize an option, tap its toggle to **On** . The following options are available:
 - **Brightness and Contrast:** Toggle the **Brightness/Contrast** option.
 - **Auto-Shutdown options:** Toggle the **Auto-Shutdown** feature and select the Auto-Shutdown duration.
 - **Video Rotation:** Toggle the **Video Rotation** menu option.
 - **Snapshot:** Toggle the **Snapshots** option.
 - **Video Recording:** Toggle the **Video Recording** option.

When the settings are configured, tap the check mark to proceed to the next setting.

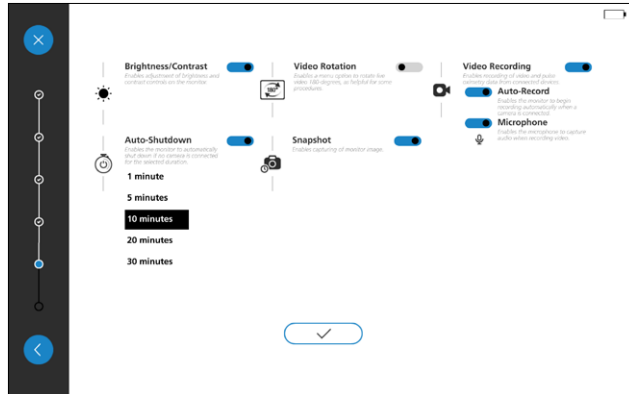

6. Enter a name for the monitor to help identify it. If a name is not needed, tap the check mark to proceed to the confirmation window.

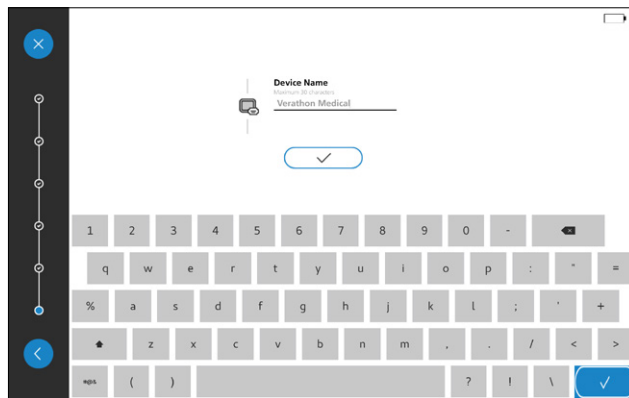

7. When the settings wizard is done, tap the check mark to return to the Home screen.

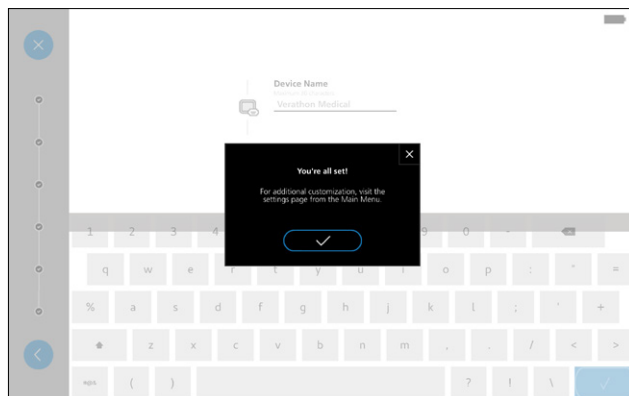

8. To configure system settings not covered in the Settings Wizard, or to change existing settings, continue to [Procedure 5, Configure User Settings \(Optional\)](#).

Procedure 5. Configure User Settings (Optional)

The Settings menu allows you to configure, change, or view the following system settings and information:

Feature Settings Tab



- System Sounds
- Brightness/Contrast
- Auto-Shutdown
- Video Rotation
- Dynamic Light Control
- Snapshot
- Video Recording
- Video Timestamps

Regional Settings tab

- Date
- Date format
- Time
- Time format
- Daylight Saving Time
- Time Zone list



Administrative Settings Tab

- Usage Statistics
- Device Name
- Security Code
- Note Fields
- System Version
- Reset Settings

A setting is switched on or off by tapping its toggle to the right  (on) or left  (off). When a setting is on, additional configuration options may appear.

FEATURE SETTINGS TAB

Use the **Feature Settings** tab to modify the System Sounds, Brightness/Contrast, Auto-Shutdown, Video Rotation, Dynamic Light Control, Snapshot, Snapshot Timestamps, Video Recording, Auto-Record, Microphone, and Video Timestamps settings.

1. To access the **Feature Settings** tab, from the Home screen, tap the **Main Menu**  button, and then tap the **Settings**  button.

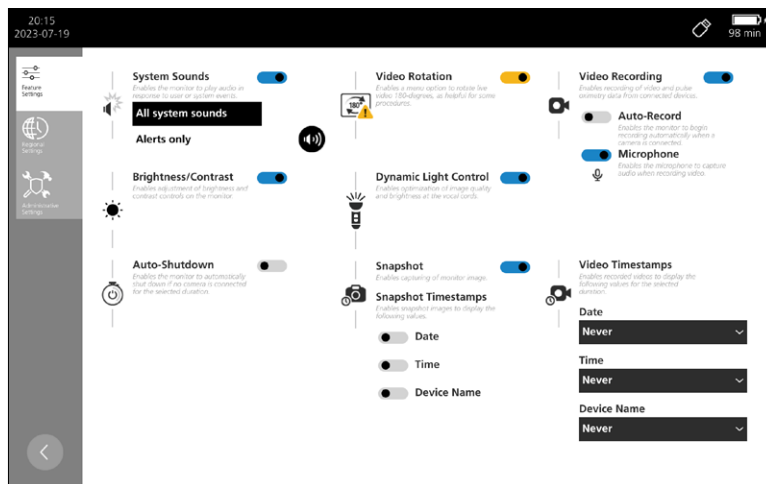



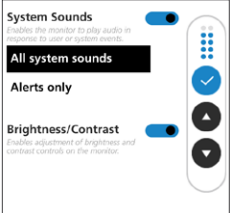



Table 5. Feature Settings

SETTING	FUNCTION
System Sounds	<p>Toggles whether sound effects are heard when buttons are pressed. When on, provides options for all systems sounds, or alerts only.</p> <p>When the System Sounds are toggled on, tap the Speaker  button to access the following volume controls:</p> <ul style="list-style-type: none"> • Volume Up  — Turns the volume up. • Volume Down  — Turns the volume down. • Check mark  — Saves the volume settings. 
Brightness/Contrast	Toggles whether the brightness button and contrast button is shown on the home screen..
Auto-Shutdown	Toggles automatic system shutdown. When this feature is on and no scopes are connected, the monitor automatically powers off after the set time. Turn on to show the available timer settings.
Video Rotation	Toggles whether the video rotation button is shown in the main menu.
Dynamic Light Control	Toggles the Dynamic Light Control (DLC) icon's default setting on the main window. The DLC icon only appears when a compatible video laryngoscope is attached. Users can tap the icon at any time to toggle the feature on or off. When on, it enables optimization of image quality and brightness at the vocal cords. For information on compatible scopes, see the <i>GlideScope Video Laryngoscopes Operations & Maintenance Manual</i> (part number 0900-4940)
Snapshots	<p>Enables access to the following toggles for the Snapshot Timestamps:</p> <ul style="list-style-type: none"> • Date • Time • Device name
Video Recording	<p>Toggles whether the record button is shown on the Home screen. When on, the following settings are shown.</p> <ul style="list-style-type: none"> • Auto-Recording — Toggles whether video starts recording automatically. • Microphone — Toggles whether the microphone captures audio when recording video. • Video Timestamps — Settings for the date, time, and device name video timestamps. Each of these can be set to always show, only show for the first five seconds, or never show.

REGIONAL SETTINGS TAB

Use the **Regional Settings** tab to choose the date, date format, time, time format, daylight saving time, and time zone settings.

1. To access the **Regional Settings** tab, from the Home screen, tap the **Main Menu**  button, and then tap the **Settings**  button.
2. Tap the **Regional Settings** tab. The Regional Settings appear.

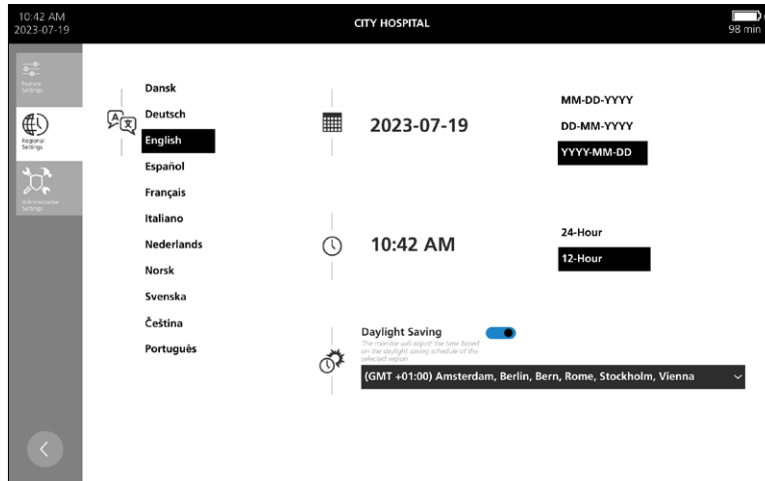



Table 6. Regional Settings

SETTING	FUNCTION
Date	Sets the system date.
Date format	Sets how the date is formatted.
Time	Sets the system time.
Time format	Toggles the monitor's time format between 12 and 24 hour.
Daylight Saving Time	Toggles whether Daylight Saving is on or off.
Time Zone list	Drop-down list to set the time to the local time zone.

ADMINISTRATIVE SETTINGS TAB

Use the **Administrative Settings** tab to modify the Note Fields, Device Name, and Security Code* settings, as well as access Usage Statistics for the monitor and Power Cycle Times for the monitor and any currently attached scopes.

1. To access the **Administrative Settings** tab, from the Home screen, tap the **Main Menu**  button, and then tap the **Settings**  button.
2. Tap the **Administrative Settings** tab. The Administrative Settings appear.

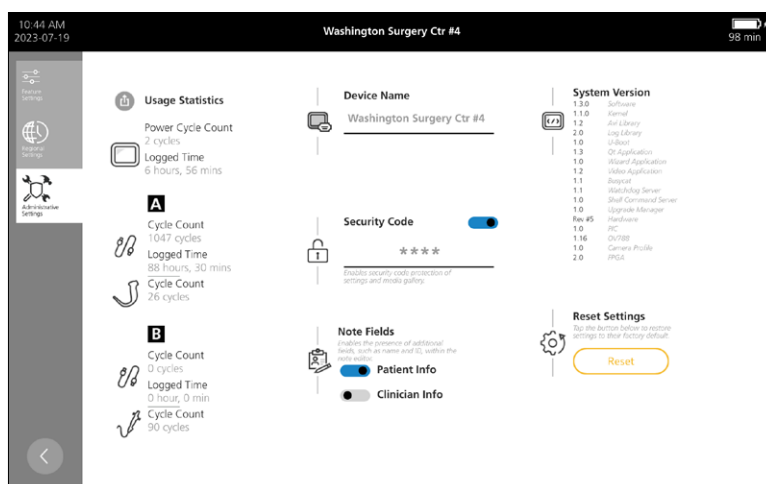



Table 7. Administrative Settings

SETTING	FUNCTION
Usage Statistics	Displays information such as the logged time and power cycle counts.
Device Name	Sets a device name that is shown in the status bar at the top of the display and in video and snapshot time-stamps when the Timestamps setting is on. For more information on Timestamps, see Feature Settings Tab on page 25.
Security Code*	Sets a security code that when set, is required to access the Settings  menu and Gallery  .
Note Fields	Enables the presence of additional fields within the note editor, such as Clinician Information and Patient Information.
System Version	Displays software versions for various system resources.
Reset Settings	Restores all settings back to factory defaults.

* If the security code has been forgotten, please contact Verathon Customer Care to request a security code reset USB flash drive. For contact information, visit verathon.com/service-and-support

Procedure 6. Attach the Video Cable and Scope

The video cable attaches the scope to the monitor, supplying power to the scope and transmitting video data from the camera to the monitor.

This procedure provides basic instruction on connecting compatible video cables and scopes to the monitor. For detailed information about cables and scopes, refer to one of the following manuals or contact Verathon Customer Care:

- *GlideScope Video Laryngoscopes Operations & Maintenance Manual* (part number 0900-4940)
- *GlideScope BFlex Single-Use Bronchoscopes Operations & Maintenance Manual* (part number 0900-4939)

The following images show the initial video layouts when one or two scopes are connected to the monitor. To change the layout after the scopes are connected, see [Adjust Video Layout](#) on page 36.

If the monitor doesn't detect an attached scope, the following image displays. Once a scope is connected, the video from the camera will be displayed on the screen.

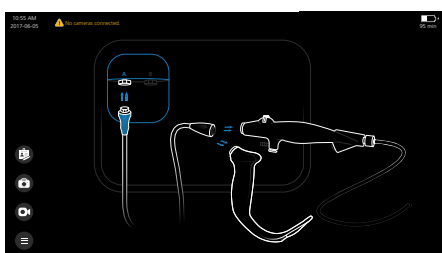

Regardless of the video input being used, when a single scope is connected to the monitor, the video feed displays in the center.

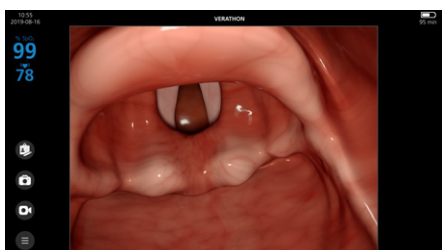

When connecting two scopes to a Core 15 monitor, the video feeds are displayed side-by-side using the GlideScope Core Dual View function.

If a video laryngoscope is already connected to the monitor and a bronchoscope is connected second, regardless of the input used, the bronchoscope's video feed displays on the right.

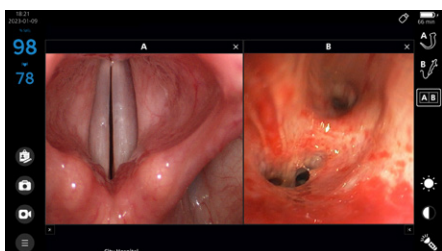

1. Align the dot on the cable connector to the dot on the monitor's A or B video connector, and then fully insert the cable. The connector attaches to the monitor.

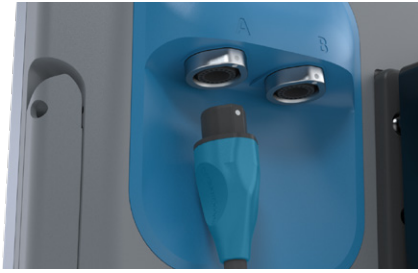

2. To disconnect the video cable, hold the cable connector in one hand and support the monitor with the other, and then pull. The cable disconnects from the monitor.

Option 1. GlideScope Core Video Cable

1. Bring into line the alignment marks on the video cable and scope connectors, and then fully insert the video cable into the scope connector port. You will hear a click when the cable is successfully connected.

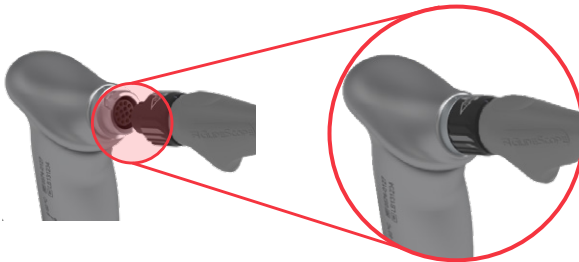

2. To disconnect the scope from the video cable, hold the scope in one hand, twist the cable's locking collar in the direction specified by the arrow on the collar, and then pull. The scope disconnects from the cable.

Option 2. Smart and QuickConnect Cables

It is recommended that you leave single-use accessories in their packaging while connecting the cable and that you do not remove it until you are ready to perform the procedure. This helps ensure that the blade remains as clean as possible until you are ready to use it.

1. Bring into line the alignment marks on the video cable and scope connectors, and then fully insert the video cable into the scope connector port.



2. To disconnect the scope from the video cable, hold the cable connector in one hand and the scope's body in the other, and then pull. The video component disconnects from the cable.

Procedure 7. Attach the USB Device (Optional)

Connecting a USB drive to one of the USB ports allows you to export exams that were saved to the internal memory. The ports also allows a Nonin 3231 USB External Pulse Oximeter to be attached. The SpO₂ reading from the sensor is shown on the Core display for convenience, but should not be used for diagnostic purposes.

1. On the back panel of the monitor, remove the rubber cover from the USB and HDMI connector panel.

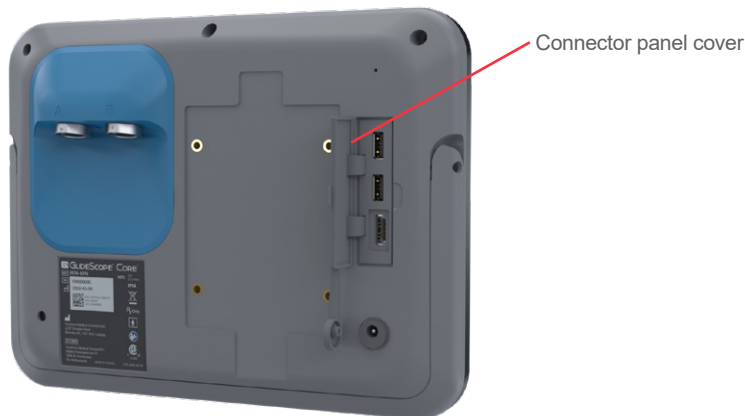

2. Connect the USB device to the one of the USB ports.

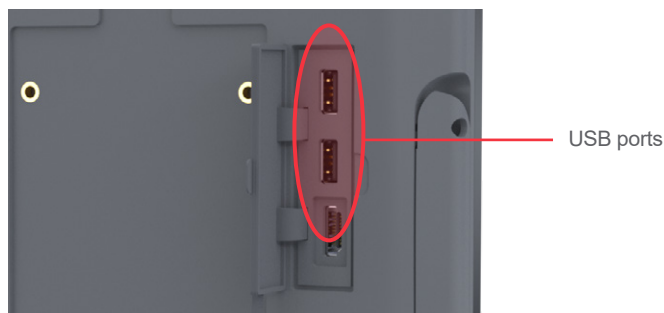

3. If you connect a USB drive, the display shows a USB icon  to indicate a drive is attached and available to use.

If you are using a pulse oximeter, the SpO₂ information from the pulse oximeter appears on the screen.

Procedure 8. Connect to an External Monitor (Optional)



Please read the [Hoiatused ja ettevaatusabinõud](#) section before performing the following task.

IMPORTANT

To maintain electromagnetic interference (EMI) within certified limits, the system must be used with the cables, components, and accessories specified or supplied by Verathon. For additional information, see the [System Parts & Accessories](#) and [Component Specifications](#) sections. The use of accessories or cables other than those specified or supplied may result in increased emissions or decreased immunity of the system.

By using an HDMI cable, you can connect the video monitor to an external monitor that is approved for medical use.

Note: Image quality on the external monitor may vary according to the resolution of the external monitor.

1. On the back panel of the monitor, remove the cover from the USB and HDMI connector panel.

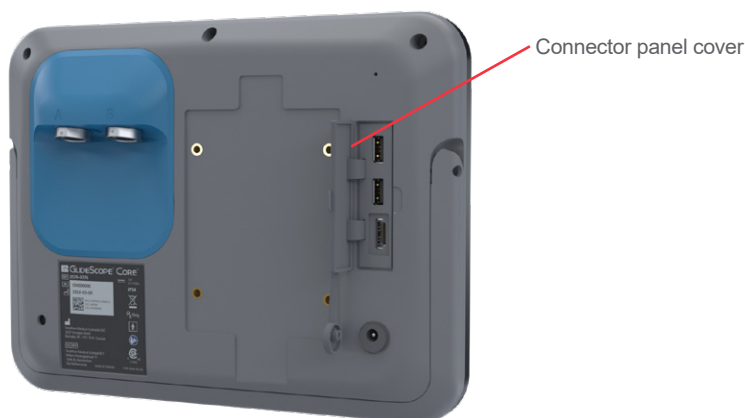

2. Connect one end of the HDMI cable to the HDMI port.

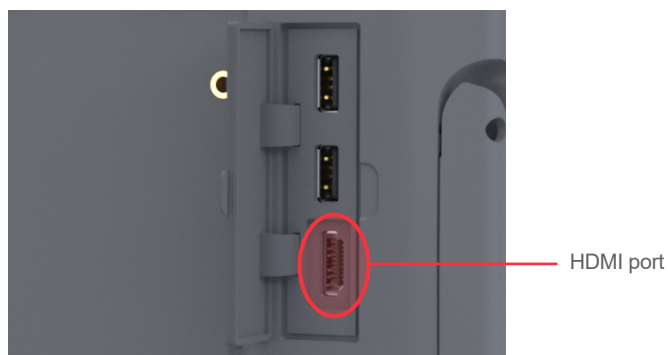

3. Connect the other end of the cable to the HDMI port on an external monitor approved for medical use.
4. To stop sending video to an external monitor, disconnect either end of the HDMI cable.



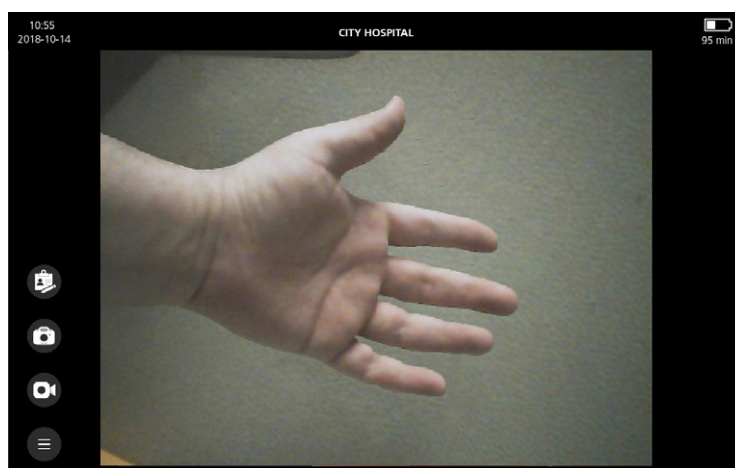

Procedure 9. Perform a Functional Check

Before you use the device for the first time, perform the following functional check to ensure that the system is working properly. Please contact your Verathon Customer Care representative if your system does not function as described below.

1. Fully charge the monitor battery (this takes approximately 4 hours).
2. Attach the video cable and scope to the monitor, according to the instructions in [Attach the Video Cable and Scope](#) on page 29.
3. Press the **Power**  button. The monitor turns on.
4. Look at the monitor screen, and verify that the image displayed is being received from the scope.



Note: There may be a slight blade intrusion in the upper-left corner of the monitor, and a thin line may appear along the top. These blade edges are captured in the view because of the wide-angle camera lens used in the video laryngoscope. This image acts as a frame of reference during the intubation process and ensures that the orientation of the image is correct in the monitor.

5. Tap the **Record**  button. The record button turns red to indicate the monitor has started recording.
6. Tap the **Record**  button again. The recording stops.
7. Tap the **Snapshot**  button. A snapshot of the video display area is taken.
8. From the **Home** screen, tap the **Main Menu**  button, and then tap the **Gallery**  button to verify the video and snapshot successfully recorded. For more information on using the Gallery, see [Use the Gallery](#) on page 38.

Using the Device

Prior to using the device, set up the device according to the instructions in the previous chapter, and verify the setup by completing Step 1 through Step 4 of the procedure [Perform a Functional Check](#) on page 33.



Please read the [Hoiatused ja ettevaatusabinõud](#) section before performing the following tasks.

This chapter consists of the following:

- [Prepare the System](#)
- [Use a USB Pulse Oximeter](#)
- [Adjust Video Layout](#)
- [Rotate the Display](#)
- [Record Video or Take a Snapshot](#)
- [Use the Gallery](#)

Procedure 1. Prepare the System

In this procedure, you select and attach the appropriate video and USB accessories for the patient, turn the system on, and verify that the system is functioning properly. For a list of all compatible scopes, see the *GlideScope Video Laryngoscopes Operations & Maintenance Manual* (part number 0900-4940) and the *GlideScope BFlex Single-Use Bronchoscopes Operations & Maintenance Manual* (part number 0900-4939).

1. If you are using a reusable scope, ensure that each component has been properly cleaned, disinfected, or sterilized according to the guidance provided in the *GlideScope Video Laryngoscopes Operations & Maintenance Manual* (part number 0900-4940).
2. Using the information in the *GlideScope Video Laryngoscopes Operations & Maintenance Manual* (part number 0900-4940) or the *GlideScope BFlex Single-Use Bronchoscopes Operations & Maintenance Manual* (part number 0900-4939), in combination with a clinical assessment of the patient and the experience and judgment of the clinician, select the scope that is appropriate for the patient and procedure.
3. Attach the chosen scope's video cable to the monitor, according to the instructions in [Attach the Video Cable and Scope](#) on page 29.
4. Press the **Power**  button. The video monitor turns on.

Note: If the monitor locks up or becomes unresponsive for any reason, press and hold the Power button for 10 seconds to reboot the system.
5. Ensure that the battery is sufficiently charged. If necessary, connect the monitor directly to power.
6. On the monitor screen, verify that the image displayed is from the scope's camera. In the image from certain video laryngoscopes, a small portion of the blade may be visible on the upper left corner or top of the monitor screen.

Procedure 2. Use a USB Pulse Oximeter

IMPORTANT

The SpO₂ values displayed on the monitor can be used as a convenient secondary display. These are not intended for patient diagnosis. For direction on using the USB pulse oximeter, please refer to the Nonin instructions for use.

The GlideScope Core monitor is compatible with the Nonin 3231 USB External Pulse Oximeter. When connected, the SpO₂ and pulse rate can be found in the upper left corner of the display.

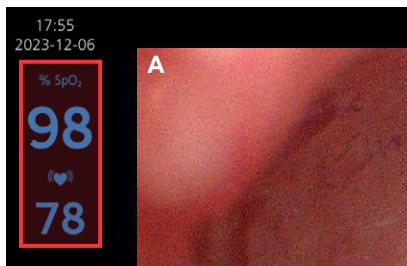

1. On the back panel of the monitor, remove the rubber cover from the USB and HDMI connector panel.

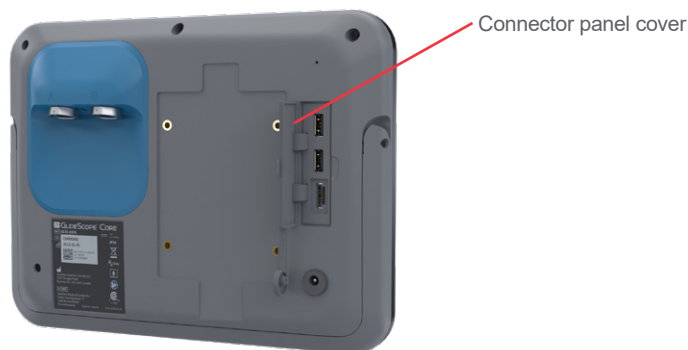

2. Connect the USB pulse oximeter to the one of the USB ports.

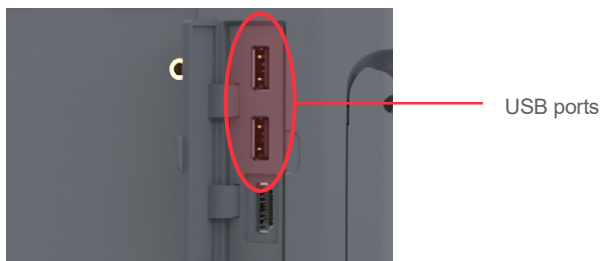







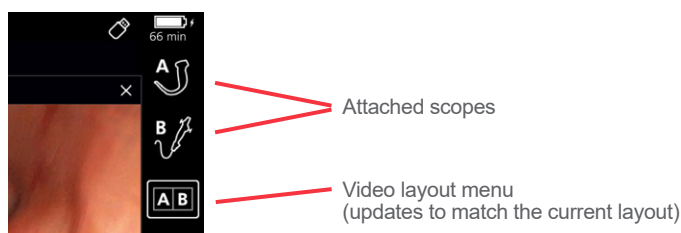

3. When connected, the display shows a USB icon  to indicate the device is attached.
4. Place the Nonin 3231 USB External Pulse Oximeter according to the manufacturer's instruction. Once placed, the SpO₂ information from the device appears on the screen.





Procedure 3. Adjust Video Layout

When the monitor has two scopes connected, a video layout menu is available. This menu allows you to select how the video feeds are displayed.







1. With two scopes connected to the monitor, either tap the attached scope's icon to isolate its video feed, or to choose a specific configuration, tap the **Video Layout Menu** button and select one of the following configurations for the desired video feed layout:

MONITOR	BUTTON	CONFIGURATION
Core 10 and Core 15		Main video feed: Input A Secondary video feed: Off
		Main video feed: Input B Secondary video feed: Off
		Main video feed: Input A Secondary video feed: Off
		Main video feed: Input B Secondary video feed: Off
Core 10		Main video feed: Input A Secondary video feed: Input B
		Main video feed: Input B Secondary video feed: Input A
Core 15		Left video feed: Input A Right video feed: Input B
		Right video feed: Input B Left video feed: Input A

2. If you are viewing both video feeds and would like to change the location of a video window, tap the **Move Left**  or **Move Right**  button in one of the bottom corners of the video window.
3. To close a video window, tap the **Close**  button at the top right corner of the video window or select a single video layout from the **Video Layout** menu.
4. When the main video feed is isolated to a bronchoscope, the **MagnaView**  button is available at the bottom right corner of the video feed. Tap the button to zoom in on the video.
5. Tap the **Standard View**  button to return the video feed to normal.

Procedure 4. Rotate the Display

The display can be rotated 180 degrees if needed. The option to show the video rotation button can be turned on or off in the user settings. To change this setting, see [Configure User Settings \(Optional\)](#) on page 25.

1. Tap the **Main Menu**  button, and then tap the **Video Rotation**  button. The video feed, including video sent to an external monitor, rotates 180 degrees, and a gold **Video Rotation**  button appears on the right side of the display.
2. To return the video feed to its normal orientation, tap the **Video Rotation**  button on the right side of the display.

Note: When two cameras are attached to the monitor, the Video Rotation button appears below the video layout menu icons. The video layout menu icons are also highlighted in gold.

Procedure 5. Record Video or Take a Snapshot



IMPORTANT

The video signals produced and used by this system are intended for device positioning only. Do not use images produced by this system for diagnostic purposes.

The monitor is equipped with video* and audio recording features, and the ability to save snapshots of the live display on the monitor and make notes for the current session. The system saves this data to its internal memory. You can view the recordings or snapshots on the video monitor, or export them to a USB flash drive to view them on a computer.

AUTOMATIC RECORDING AND AUDIO

By default, the automatic video recording and audio recording options are disabled. When automatic video recording is enabled, the monitor starts recording once a scope is connected, or once the monitor is powered on with a scope already connected. When audio recording is enabled, the system records audio with the video.

1. To enable automatic recording and audio recording, from the Home screen, tap the **Main Menu**  button, and then tap the **Settings**  button to access the [Feature Settings Tab](#).
2. From the [Feature Settings Tab](#), ensure Video Recording is enabled, and then adjust the Auto-Record or Microphone options as needed.

MANUAL RECORDING AND SNAPSHOTS



1. To start recording video manually, press the **Record**  button. Video recording starts and is saved to the monitor. The **Record** button turns red  to indicate the recording has started.

If audio recording is enabled, the **Record** button includes a small microphone symbol to confirm the video is recording with audio.

Figure 9. Record button with audio enabled



* With less than 10 minutes of battery life remaining, the Record button is hidden and the monitor will not allow video recording. If a video is already recording, the monitor will save it, and then stop recording.

2. When you are finished recording, press the **Record**  button again. The recording stops.
3. If you would like to save a photo of the live display, press the **Snapshot**  button. A frame briefly appears around the video to indicate the snapshot has been taken. This can also be done while the recording video.
4. To create a patient note, press the **Note Editor**  button. The Note Editor opens.
Note: If a video is recording, tapping the Note Editor button saves the video and opens the Note Editor.
5. For information on viewing the recorded files, continue to [Procedure 6, Use the Gallery](#).

Procedure 6. Use the Gallery





Please read the [Hoiatused ja ettevaatusabinõud](#) section before performing the following task.

IMPORTANT

Do not remove the USB flash drive while transferring files from the monitor to the USB.

ACCESS THE GALLERY

- From the **Home** screen, tap the **Main Menu**  button, and then tap the **Gallery**  button.
Note: If a security code has been created for the monitor, you will be prompted to enter it before you can access the Gallery.

SORT THE GALLERY

- Tap the up or down arrows by the **Sort by Date** icon. When an arrow is selected, it is highlighted and underlined with a white line.



SELECT FILES

1. Tap and hold the file, or tap the check box directly. A file is selected when a mark appears in the check box at the upper left corner of the thumbnail. Repeat to select additional files, or to deselect a file.

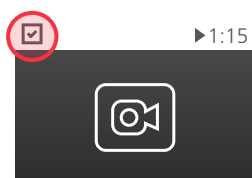

2. To select all the files in a row, tap the **Select All** check box to the left of the row.

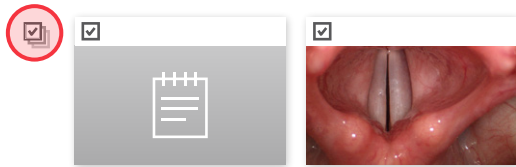

FAVORITES

1. To mark a file as a favorite, tap the check box to select the file(s), and then tap the **Favorite**  button in the left bar. A star appears in the thumbnail.

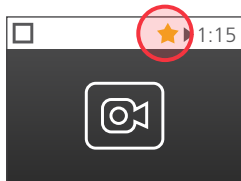

Note: Files marked as favorites are protected from being removed from the monitor. If you attempt to move the file to a USB drive, it will be copied to the drive and the file will remain on the monitor.

2. If you would like to turn on or off the Favorites Filter, from the Status Bar, tap the button. When on, the Gallery will show only files marked as a favorite.

Figure 10. Favorite Filter Off

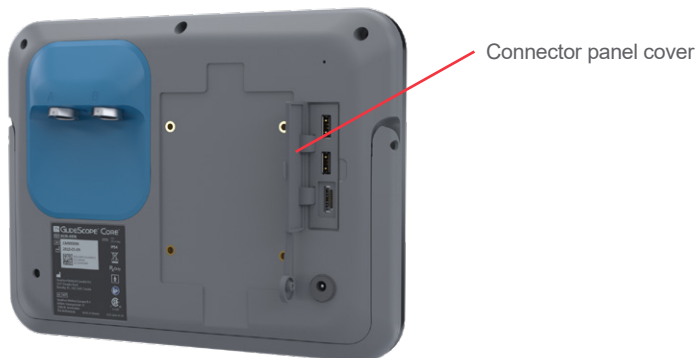

Figure 11. Favorite Filter On







EXPORT VIDEO OR SNAPSHOT

1. On the back panel of the monitor, remove the rubber cover from the USB and HDMI connector panel.

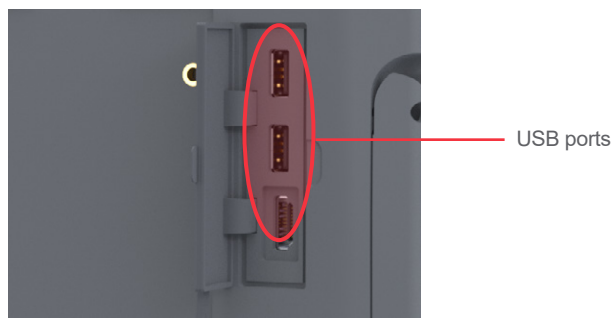



2. Connect the USB flash drive to the one of the USB ports.

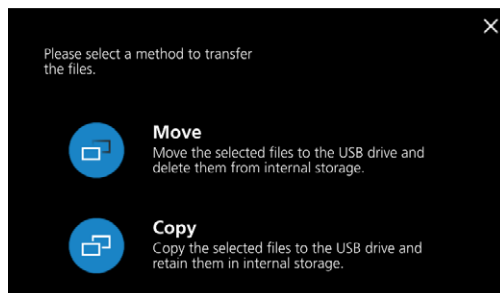

3. Ensure that the USB flash drive is detected by verifying the USB  icon is visible at the top of the screen.
4. From the Home screen, tap the **Main Menu**  button, and then tap the **Gallery**  button.
5. Tap the selection box at the top left of the file thumbnail to select the file or files you want to export.
6. Tap the **Export**  button. The Export Selection box appears.



7. Tap either the **Move**  button or the **Copy**  button. The files are moved or copied to the USB drive.
8. After the files have finished exporting, remove the USB drive from the monitor. Files can now be reviewed or backed up on a computer.

Viewing Media

If you would like to export, delete, or favorite a file being viewed, tap the check box at the upper left corner of the file thumbnail, and then tap the corresponding button on the left of the display.

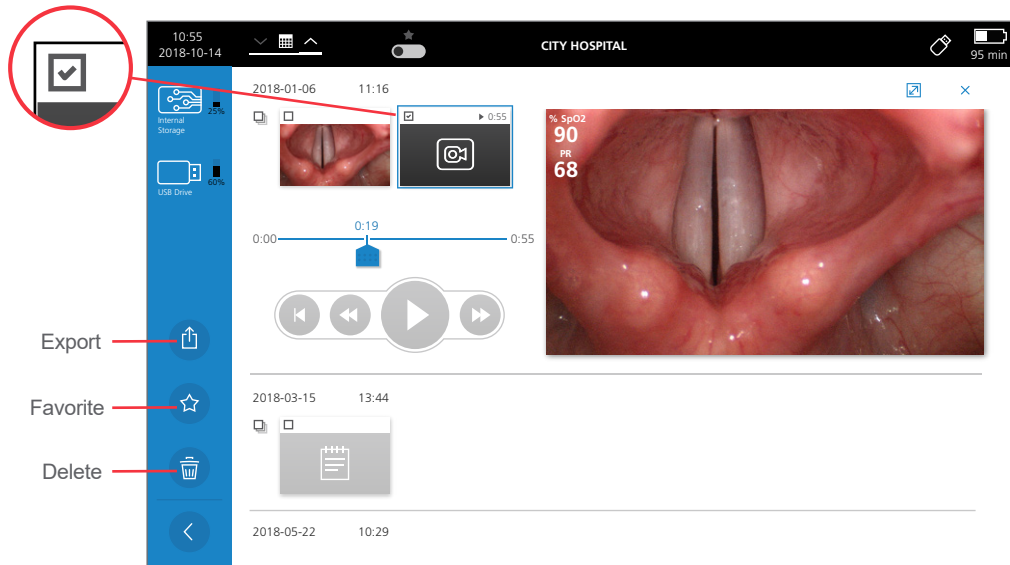

VIDEO PLAYBACK

1. To review a recorded video, tap its thumbnail. The Video Playback window opens.

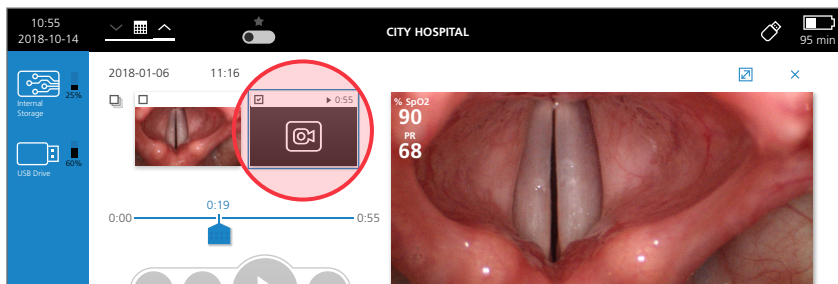

2. The media controls in the Video Playback window provide the following functions:

BUTTON	FUNCTION
	Restart: Rewinds selected video to beginning.
	Rewind: Rewinds selected video by 20%.
	Play Video: Plays selected video. Changes to pause button while video is playing.
	Pause Video: Pauses the playing video. Changes to play button while video is paused.
	Fast Forward: Skips selected video by 20%.
	Playhead: Shows the current location in the video. Can be dragged horizontally to jump to a specific location in the video.
	Expand: Expands the video media to fit the screen while maintaining the correct aspect ratio.

VIEW A SNAPSHOT

- To review a recorded snapshot, tap its thumbnail. The Photo Viewer opens.

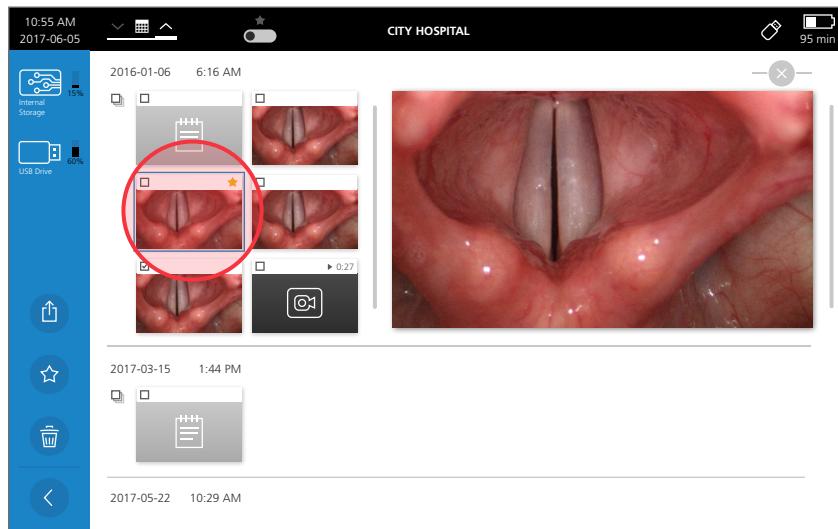

VIEW PATIENT NOTES

- To review a patient note, tap its thumbnail. The note viewer opens.

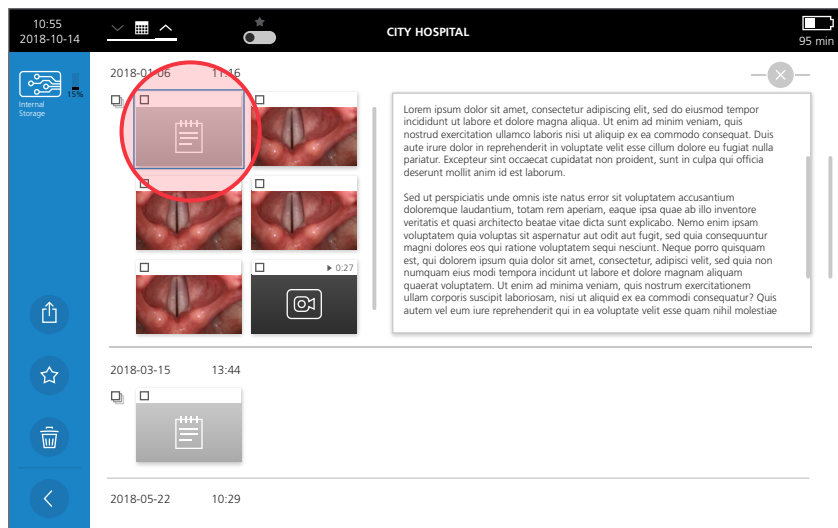

- To edit the note, tap inside the text box. A keyboard appears. This can only be done during the same session.



- Using the keyboard, edit the note as needed, and then tap the check mark button to save your edits.
Note: To see alternates for a character, tap and hold on the character.

Reprocessing

Some of the components in this manual may require cleaning, low-level disinfection, high-level disinfection, or sterilization between uses or under specific circumstances. For information about the cleaning, disinfection, and sterilization requirements for these components, refer to the GlideScope and GlideRite Products Reprocessing Manual, which is available at [verathon.com/service-and-support/glidescope-reprocessing-products](https://www.verathon.com/service-and-support/glidescope-reprocessing-products).

Maintenance & Safety

Periodic Inspections

No periodic inspections, maintenance, or calibrations are required by Verathon.

Report any suspected defects to Verathon Customer Care or your local representative. For contact information, visit [verathon.com/service-and-support](https://www.verathon.com/service-and-support).

GlideScope Core Battery

Under normal operating conditions, the monitor battery will maintain its full charge capacity through approximately 500 charge and discharge cycles, after which the battery's charge capacity may decrease. For more information about the battery, see [Component Specifications](#) on [page 48](#).

The battery is not user-replaceable. In case of battery malfunction, do not attempt to replace the monitor battery. Any attempts to replace the battery by unauthorized service technicians may cause serious harm to the user and will void the warranty. Please contact your Verathon Customer Care representative for more information on battery replacement.

System Software

Verathon may release software upgrades for the video monitor. Software upgrades are supplied directly by Verathon or an authorized representative, and installation instructions are provided with the upgrade.

This manual documents the most current software version available at the time of writing. If your monitor does not function as described in this manual, or to determine if your software should be updated, contact Verathon Customer Care.

Do not perform any software upgrades from third-party vendors or attempt to modify the existing software. Doing so may damage the monitor and void the warranty.

For information about software language options, see [Regional Settings tab](#) on [page 25](#).

Device Repair

The GlideScope Core components are not user-serviceable. Verathon does not make available any type of circuit diagrams, component parts lists, descriptions, or other information that would be required for repairing the device and related accessories. All service must be performed by a qualified technician.

If you have any questions, contact your local Verathon representative or Verathon Customer Care.



Please read the [Hoiatused ja ettevaatusabinõud](#) section.

Device Disposal

The system and related accessories may contain batteries and other environmentally hazardous materials. When the instrument has reached the end of its useful service life, it must be disposed of in accordance with WEEE requirements. Coordinate disposal through your Verathon Service Center, or alternatively, follow your local protocols for hazardous waste disposal.

Limited Warranty

ORIGINAL TOTAL CUSTOMER CARE WARRANTY

THIS LIMITED WARRANTY (“Warranty”) is provided by Verathon Inc. (“Verathon”) to the Customer for the GlideScope® Core products; namely the video monitor and smart cable (“Products”). Unless modified by separate negotiated agreement, this Warranty, together with the terms as set out in the written quotation, order acknowledgment, and invoice, in addition to Verathon’s standard Terms and Conditions of Sale, creates the entire agreement between Verathon and Customer (“Agreement”), superseding all other communications and documentation. Verathon expressly rejects any different, additional, or preprinted terms contained or referenced in any purchase order or other documentation supplied by Customer.

SCOPE OF COVERAGE: This Warranty covers service and repair of all malfunctions (mechanical, electrical, and other defects) associated with the Products purchased by Customer from Verathon, for a period of two (2) years from Product shipment date (“Term”). Replacement parts will be new, rebuilt or non-original manufacturer’s parts that perform to the factory specifications of the Product at Verathon’s sole option.

Verathon will perform repair and replacement services (“Service”) only on Products purchased from an authorized dealer. If Products or components are purchased from an unauthorized dealer, or if the original factory serial number has been removed, defaced, or altered, this Warranty is void.

If a Product purchased by Customer requires Service, Verathon will, at its discretion, either repair or replace the Product and may provide a loaner unit, at Customer’s request. Customer shall send the defective Product to Verathon (cleaned and disinfected as appropriate). All exchanged parts become property of Verathon.

EXCLUSIONS: This Warranty excludes problems caused by the Customer’s acts (or failure to act), the acts of others, or events beyond Customer’s reasonable control including:

- Theft, misuse, abuse, extraordinary wear and tear, or neglect.
- Misapplication, improper use such as cleaning with chemicals, disinfects, or autoclaving, or other failure to follow Verathon’s written product instructions and safety precautions contained in the Operations and Maintenance Manual.
- Exposure to temperatures in excess of 60°C (140°F).
- Use of Products in conjunction with hardware, software, components, services, accessories, attachments, interfaces, or consumables, other than those supplied or specified by Verathon.
- Products repaired or maintained by anyone other than a Verathon authorized service provider.
- Modification, disassembly, rewiring, re engineering, recalibration, and/or reprogramming of Products other than as specifically authorized by Verathon in writing.

COVERED COMPONENTS: Warranty coverage applies to the following components:

- GlideScope Core Video Monitor
- GlideScope Core Smart Cable

Additional reusable components purchased either singularly or as a part of a system, including GlideScope® Workstations are limited to a one-year factory warranty. Consumable items are not covered under this warranty.

OBTAINING SERVICE: To request service, Customer must first contact Verathon's Customer Care Department to obtain a return authorization number pursuant to the guidelines provided.

VERATHON SERVICE: Verathon shall provide Services in a timely and competent manner by professionals qualified to render such services. Verathon agrees that all Services performed, or parts provided by Verathon shall be free from defect in materials and workmanship for the Term. Customer shall notify Verathon if and to what respect any of said guarantees have not been met and Verathon shall promptly, at its own expense and sole discretion, re-perform such services and make such alteration, repair, or replacement as may be necessary to meet the guarantees hereunder so long as the non-performance is due to a manufacturer defect and not physical or Customer induced issues after the service is completed.

EXTENDED WARRANTIES: Customer may purchase a Premium Total Customer Care warranty that extends this Limited Warranty. For more information, contact Verathon's Customer Care Department or your local representative.

LIMITED REMEDY: This Warranty gives Customer specific legal rights which may vary based on local law. When, under applicable law, implied warranties are not allowed to be excluded in their entirety, such warranties will be limited to the duration of the applicable written warranty and, for European Customers, any terms herein limiting Verathon's liability shall not apply insofar as they conflict with mandatory statutory provisions of the Product Liability Act.

TO THE FULL EXTENT ALLOWED BY LAW, THE FOREGOING LIMITED WARRANTIES AND REMEDIES ARE EXCLUSIVE AND EXPRESSLY IN LIEU OF ALL OTHER WARRANTIES, REPRESENTATIONS, TERMS, OR CONDITIONS, WRITTEN OR ORAL, EXPRESS OR IMPLIED, STATUTORY OR OTHERWISE, INCLUDING BUT NOT LIMITED TO ANY WARRANTIES, TERMS OR CONDITIONS OF MERCHANTABILITY OR FITNESS FOR A PARTICULAR PURPOSE, SATISFACTORY QUALITY, CORRESPONDENCE WITH DESCRIPTION, AND NON-INFRINGEMENT, ALL OF WHICH ARE HEREBY EXPRESSLY DISCLAIMED.

TRANSFER OF SERVICE: This Warranty extends only to Customer and may not be transferred to third parties by operation of law or otherwise.

Product Specifications

Component Specifications

Video Monitor Specifications

Table 8. Core 10 (0570-0376)

GENERAL SPECIFICATIONS		
Classification:	Electrical Class II, Applied Part BF	
Line voltage:	Range: 100–240 V AC, 50 and 60 Hz (If the power cord has a third prong, the third conductor is not intended to be a protective earth connection for the medical power supply.)	
DC power supply:	12 V DC, 2.5 A max	
Ingress protection:	IP54	
BATTERY SPECIFICATIONS		
Battery type	Lithium-ion	
Battery life	Under normal operating conditions, a fully charged, new battery lasts approximately 135 minutes.	
Charging time	Charging time off-line will take no more than 4 hours from an empty battery to a full charge.	
Rated capacity	3350 mAh	
Nominal voltage	7.2 V	
Nominal weight	110 g (0.24 lbs)	
OPERATING & STORAGE SPECIFICATIONS		
	Operating Conditions	Shipping & Storage Conditions
Temperature:	10–35°C (50 to 95°F)	-20–45°C (-4 to 113°F)
Relative humidity:	10–95%	10–95%
Atmospheric pressure:	700–1060 hPa	440–1060 hPa
COMPONENT SPECIFICATIONS		
Display	TFT Color, 1280 x 800 px (MagnaView 720x720)	
Internal memory	112 GB	
Monitor (A)	25.7 cm (10.1 in)	
Height (B)	206 mm (8.1 in)	
Width (C)	269 mm (10.6 in)	
Depth (D)	48.5 mm (1.9 in)	
Weight	1.32 kg (2.9 lb)	

Table 9. Core 10 FHD (0570-0436)

GENERAL SPECIFICATIONS		
Classification:	Electrical Class II, Applied Part BF	
Line voltage:	Range: 100–240 V AC, 50 and 60 Hz (If the power cord has a third prong, the third conductor is not intended to be a protective earth connection for the medical power supply.)	
DC power supply:	12 V DC, 2.5 A max	
Ingress protection:	IP54	
BATTERY SPECIFICATIONS		
Battery type	Lithium-ion	
Battery life	Under normal operating conditions, a fully charged, new battery lasts approximately 135 minutes.	
Charging time	Charging time off-line will take no more than 4 hours from an empty battery to a full charge.	
Rated capacity	3350 mAh	
Nominal voltage	7.2 V	
Nominal weight	110 g (0.24 lbs)	
OPERATING & STORAGE SPECIFICATIONS		
	Operating Conditions	Shipping & Storage Conditions
Temperature:	10–35°C (50 to 95°F)	-20–45°C (-4 to 113°F)
Relative humidity:	10–95%	10–95%
Atmospheric pressure:	700–1060 hPa	440–1060 hPa
COMPONENT SPECIFICATIONS		
Display	TFT Color, 1920 x 1200 px (MagnaView 1200x1200)	
Internal memory	112 GB	
Monitor (A)	25.7 cm (10.1 in)	
Height (B)	206 mm (8.1 in)	
Width (C)	269 mm (10.6 in)	
Depth (D)	48.5 mm (1.9 in)	
Weight	1.25 kg (2.7 lb)	

Table 10. Core 15 (0570-0404)

GENERAL SPECIFICATIONS		
Classification:	Electrical Class II, Applied Part BF	
Line voltage:	Range: 100–240 V AC, 50 and 60 Hz (If the power cord has a third prong, the third conductor is not intended to be a protective earth connection for the medical power supply.)	
DC power supply:	12 V DC, 2.5 A max	
Ingress protection:	IP54	
BATTERY SPECIFICATIONS		
Battery type	Lithium-ion	
Battery life	Under normal operating conditions, a fully charged, new battery lasts approximately 90 minutes.	
Charging time	Charging time off-line will take no more than 4 hours from an empty battery to a full charge.	
Rated capacity	3350 mAh	
Nominal voltage	7.2 V	
Nominal weight	110 g (0.24 lbs)	
OPERATING & STORAGE SPECIFICATIONS		
	Operating Conditions	Shipping & Storage Conditions
Temperature:	10–35°C (50 to 95°F)	-20–45°C (-4 to 113°F)
Relative humidity:	10–95%	10–95%
Atmospheric pressure:	700–1060 hPa	440–1060 hPa
COMPONENT SPECIFICATIONS		
Display	TFT Color, 1366 x 768 px (MagnaView 768x768)	
Internal memory	112 GB	
Monitor (A)	39.6 cm (15.6 in)	
Height (B)	280 mm (11 in)	
Width (C)	415 mm (16.3 in)	
Depth (D)	55.2 mm (2.2 in)	
Weight	3.10 kg (6.8 lb)	

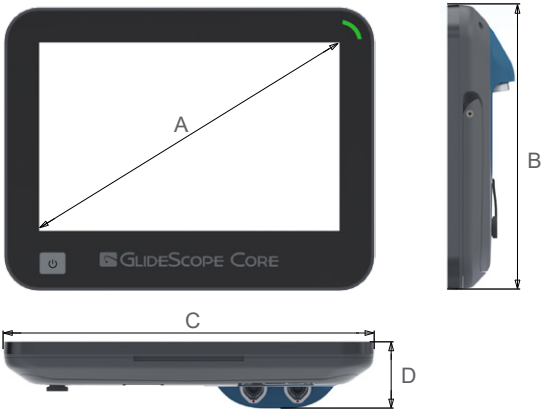
Table 11. Core 15 FHD (0570-0437)

GENERAL SPECIFICATIONS		
Classification:	Electrical Class II, Applied Part BF	
Line voltage:	Range: 100–240 V AC, 50 and 60 Hz (If the power cord has a third prong, the third conductor is not intended to be a protective earth connection for the medical power supply.)	
DC power supply:	12 V DC, 2.5 A max	
Ingress protection:	IP54	
BATTERY SPECIFICATIONS		
Battery type	Lithium-ion	
Battery life	Under normal operating conditions, a fully charged, new battery lasts approximately 85 minutes.	
Charging time	Charging time off-line will take no more than 4 hours from an empty battery to a full charge.	
Rated capacity	3350 mAh	
Nominal voltage	7.2 V	
Nominal weight	110 g (0.24 lbs)	
OPERATING & STORAGE SPECIFICATIONS		
	Operating Conditions	Shipping & Storage Conditions
Temperature:	10–35°C (50 to 95°F)	-20–45°C (-4 to 113°F)
Relative humidity:	10–95%	10–95%
Atmospheric pressure:	700–1060 hPa	440–1060 hPa
COMPONENT SPECIFICATIONS		
Display	TFT Color, 1920 x 1080 px (MagnaView 1080x1080)	
Internal memory	112 GB	
Monitor (A)	39.6 cm (15.6 in)	
Height (B)	280 mm (11 in)	
Width (C)	415 mm (16.3 in)	
Depth (D)	55.2 mm (2.2 in)	
Weight	2.98 kg (6.6 lb)	

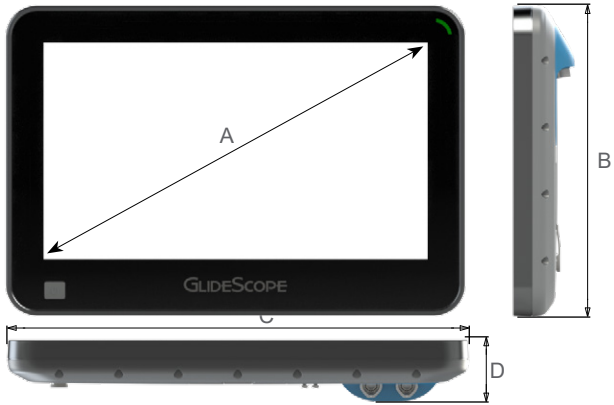

For operating conditions on video scopes, please refer to the GlideScope Video Laryngoscopes Operations & Maintenance Manual (part number 0900-4940) or the GlideScope BFlex Single-Use Bronchoscopes Operations & Maintenance Manual (part number 0900-4939).

Workstations

Table 12. Premium Workstation (0800-0636)

COMPONENT SPECIFICATIONS	
Wheelbase diameter (A)	64 cm
Min. height (B)	142 cm \pm 2 cm
Max. height (C)	165 cm \pm 2 cm
Safe working load	42 kg

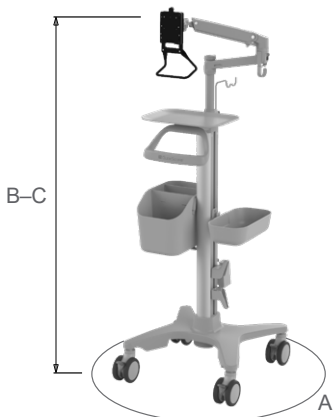
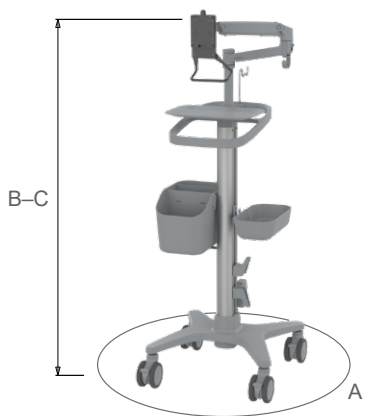

Table 13. Premium Workstation (0800-0557)

COMPONENT SPECIFICATIONS	
Wheelbase diameter (A)	64 cm
Min. height (B)	142 cm \pm 2 cm
Max. height (C)	165 cm \pm 2 cm
Safe working load	38 kg



Electromagnetic Compatibility

The system is designed to be in compliance with IEC 60601-1-2, which contains electromagnetic compatibility (EMC) requirements for medical electrical equipment. The limits for emissions and immunity specified in this standard are designed to provide reasonable protection against harmful interference in a typical medical installation.

The system complies with the applicable essential performance requirements specified in IEC 60601-1 and IEC 60601-2-18. Results of immunity testing show that the essential performance of the system is not affected under the test conditions described in the following tables. For more information about the essential performance of the system, see [Essential Performance](#) on page 1.

Electromagnetic emissions

Table 14. Guidance and Manufacturer's Declaration—Electromagnetic Emissions

The system is intended for use in the electromagnetic environment specified below. The customer or the user of the system should ensure that it is used in such an environment.

EMISSIONS TEST	COMPLIANCE	ELECTROMAGNETIC ENVIRONMENT – GUIDANCE
RF emissions CISPR 11	Group 1	The system uses RF energy only for its internal function. Therefore, its RF emissions are very low and are not likely to cause any interference in nearby electronic equipment.
RF emissions CISPR 11	Class A	The system is suitable for use in all establishments other than domestic and those directly connected to the public low-voltage power supply network that supplies buildings used for domestic purposes.
Harmonic emissions IEC 61000-3-2	Class A	
Voltage fluctuations/ flicker emissions IEC 61000-3-3	In compliance	

Electromagnetic immunity

Table 15. Guidance and Manufacturer's Declaration—Electromagnetic Immunity

The system is intended for use in the electromagnetic environment specified below. The customer or the user of the system should ensure that it is used in such an environment.

IMMUNITY TESTS	IEC 60601 TEST LEVEL	COMPLIANCE LEVEL	ELECTROMAGNETIC ENVIRONMENT – GUIDANCE
Electrostatic discharge (ESD) IEC 61000-4-2	± 8 kV contact ± 16 kV air	In compliance	Floors should be wood, concrete, or ceramic tile. If floors are covered with synthetic material, the relative humidity should be at least 30%.

Table 15. Guidance and Manufacturer’s Declaration—Electromagnetic Immunity

The system is intended for use in the electromagnetic environment specified below. The customer or the user of the system should ensure that it is used in such an environment.

IMMUNITY TESTS	IEC 60601 TEST LEVEL	COMPLIANCE LEVEL	ELECTROMAGNETIC ENVIRONMENT – GUIDANCE
Electrical fast transient/ burst IEC 61000-4-4	± 2 kV for power supply lines ± 1 kV for input/ output lines 100 kHz repetition frequency	In compliance	Mains power quality should be that of a typical hospital environment.
Surge IEC 61000-4-5	± 1 kV line(s) to line(s) ± 2 kV line(s) to earth	In compliance	Mains power quality should be that of a typical hospital environment.
Voltage dips, short interruptions and voltage variations on power supply input lines IEC 61000-4-11	0% UT; 0.5 Cycle At 0°, 45°, 90°, 135°, 180°, 225°, 270° and 315° 0% UT; 1 cycle and 70% UT; 25/30 cycles Single Phase: at 0°	In compliance	Mains power quality should be that of a typical hospital environment. If the user of the system requires continued operation during power mains interruptions, it is recommended that the system be powered from an uninterruptible power supply or a battery.
Rated Power Frequency Magnetic Fields (50/60 Hz) IEC 61000-4-8	30 A/m	In compliance	Power frequency magnetic fields should be at levels characteristic of a typical location in a typical hospital environment.
Conducted RF IEC 61000-4-6	3 Vrms 150 kHz to 80 MHz 6 Vrms in ISM bands 150 kHz to 80 MHz 80% AM at 1 kHz	In compliance	Portable and mobile RF communications equipment should be used no closer to any part of the system, including cables, than the recommended separation distance calculated from the equation applicable to the frequency of the transmitter. Recommended separation distance d (m) $d=1.2 \sqrt{P}$

Table 15. Guidance and Manufacturer’s Declaration—Electromagnetic Immunity

The system is intended for use in the electromagnetic environment specified below. The customer or the user of the system should ensure that it is used in such an environment.

IMMUNITY TESTS	IEC 60601 TEST LEVEL	COMPLIANCE LEVEL	ELECTROMAGNETIC ENVIRONMENT – GUIDANCE
Radiated RF IEC 61000-4-3	3 V/m 80 MHz to 2.7 GHz 80% AM at 1 kHz	In compliance	$d=1.2 \sqrt{P}$ 80 MHz to 800 MHz $d=2.3 \sqrt{P}$ 800 MHz to 2.5 GHz where P is the maximum output power rating of the transmitter in watts (W) according to the transmitter manufacturer and d is the recommended separation distance in meters (m). Field strengths from fixed RF transmitters, as determined by an electromagnetic site survey, ^a should be less than the compliance level in each frequency range. ^b Interference may occur in the vicinity of equipment marked with the following symbol: 

Note: U_T is the AC mains voltage prior to application of the test level.

At 80 MHz and 800 MHz, the higher frequency range applies.

These guidelines may not apply in all situations. Electromagnetic propagation is affected by absorption and reflection from structures, objects and people.

- a. Field strengths from fixed transmitters, such as base stations for radio (cellular/cordless) telephones and land mobile radios, amateur radio, AM and FM radio broadcast and TV broadcast cannot be predicted theoretically with accuracy. To assess the electromagnetic environment due to fixed RF transmitters, an electromagnetic site survey should be considered. If the measured field strength in the location in which the system is used exceeds the applicable RF compliance level above, the system should be observed to verify normal operation. If abnormal performance is observed, additional measures may be necessary, such as re-orienting or relocating the system.
- b. Over the frequency range 150 kHz to 80 MHz, field strengths should be less than 3 V/m.

Recommended separation distances

Table 16. Recommended Separation Distances between Portable and Mobile RF Communications Equipment and the GlideScope Core System

The system is intended for use in an electromagnetic environment in which radiated RF disturbances are controlled. The customer or the user of the system can help prevent electromagnetic interference by maintaining a minimum distance between portable and mobile RF communications equipment (transmitters) and the system as recommended below, according to the maximum output power of the communications equipment.

RATED MAXIMUM OUTPUT POWER OF TRANSMITTER (W)	SEPARATION DISTANCE ACCORDING TO FREQUENCY OF TRANSMITTER (m)		
	150 kHz to 80 MHz $d=1.2 \sqrt{P}$	80 MHz to 800 MHz $d=1.2 \sqrt{P}$	800 MHz to 2.5 GHz $d=2.3 \sqrt{P}$
0.01	0.12	0.12	0.23
0.1	0.38	0.38	0.73
1	1.2	1.2	2.3
10	3.8	3.8	7.3
100	12	12	23

For transmitters rated at a maximum output power not listed above, the recommended separation distance d in meters (m) can be estimated using the equation applicable to the frequency of the transmitter, where P is the maximum output power rating of the transmitter in watts (W) according to the transmitter manufacturer.

Note: At 80 MHz and 800 MHz, the separation distance for the higher frequency range applies.

These guidelines may not apply in all situations. Electromagnetic propagation is affected by absorption and reflection from structures, objects and people.

Accessory Conformance to Standards

To maintain electromagnetic interference (EMI) within certified limits, the system must be used with the cables, components, and accessories specified or supplied by Verathon. For additional information, see the [System Parts & Accessories](#) and [Component Specifications](#) sections. The use of accessories or cables other than those specified or supplied may result in increased emissions or decreased immunity of the system.

Table 17. EMC Standards for Accessories

ACCESSORY	MAX LENGTH
AC power cord	4.5 m (15 ft)
DC medical power adapter cable	1.8 m (6 ft)
Core Smart Cable	1.45 m (5 ft)
Core video cable	1.57 m (5 ft)
Core QuickConnect Cable	1.57 m (5 ft)
Core 2m QuickConnect Cable	2.03 m (6.7ft)
USB pulse oximeter cable	2 m (6.5 ft)

Glossary

The following table provides definitions for specialized terms used in this manual or on the product itself. For a full list of caution, warning, and informational symbols used on this and other Verathon products, please refer to the *Verathon Symbol Glossary* at verathon.com/service-and-support/symbols.

TERM	DEFINITION
A	Ampere
AC	Alternating current
AER	Automated endoscope reprocessor
C	Celsius
CFR	Code of Federal Regulations (U.S.)
CISPR	International Special Committee on Radio Interference
cm	Centimeter
CSA	Canadian Standards Association
DL	Direct laryngoscopy
EMI	Electromagnetic interference
ESD	Electrostatic discharge
Essential performance	The system performance necessary to achieve freedom from unacceptable risk
F	Fahrenheit
FHD	Full High Definition
g	Gram
GHz	Gigahertz
HDMI	High-definition multimedia interface
hPa	Hectopascal
Hz	Hertz
IEC	International Electrotechnical Commission
in	Inch
ISM	Industrial, scientific, and medical
kHz	Kilohertz
kV	Kilovolt
lbs	Pounds
m	Meter
mAh	Milliampere-hour
MDD	Medical Device Directive
MHz	Megahertz
mm	Millimeter
OSHA	Occupational Safety and Health Administration (federal agency in U.S.)
RF	Radio frequency

TERM	DEFINITION
RH	Relative humidity
RoHS	Restriction of the Use of Certain Hazardous Substances in Electrical and Electronic Equipment
V	Volt
Vrms	Voltage root mean squared
W	Watt
WEEE	Waste electrical and electronic equipment

verathon