



BladderScan i10™

Operations & Maintenance Manual

BladderScan
verathon

BladderScan i10™

Operations & Maintenance Manual

IMPORTANT

This manual is intended for use in Canada only. If you are outside of Canada, visit [verathon.com](https://www.verathon.com) or contact Verathon Customer Care to obtain the appropriate *BladderScan i10 Operations & Maintenance Manual* (version 0900-5005). For contact information, visit [verathon.com/service-and-support](https://www.verathon.com/service-and-support).

Effective: September 20, 2024

Caution: Federal (United States) law restricts this system to sale by or on the order of a physician.

Contact Information

To obtain additional information regarding your BladderScan system, contact Verathon Customer Care or visit [verathon.com/service-and-support](https://www.verathon.com/service-and-support).



Verathon Inc.

20001 North Creek Parkway
Bothell, WA 98011 U.S.A.
Tel: +1 800 331 2313 (US and Canada only)
Tel: +1 425 867 1348
Fax: +1 425 883 2896
[verathon.com](https://www.verathon.com)



Verathon Medical (Europe) B.V.

Willem Fenengastraat 13
1096 BL Amsterdam
The Netherlands
Tel: +31 (0) 20 210 30 91
Fax : +31 (0) 20 210 30 92

Verathon Medical (Australia) Pty Limited

Unit 9, 39 Herbert Street
St Leonards NSW 2065
Australia
Within Australia: 1800 613 603 Tel / 1800 657 970 Fax
International: +61 2 9431 2000 Tel /
+61 2 9475 1201 Fax



MDSS CH GmbH

Laurenzenvorstadt 61
5000 Aarau
Switzerland



Anandic Medical Systems AG

Stadtweg 24
8245 Feuerthalen
Switzerland



CE 0123

Copyright © 2024 Verathon, Inc. All rights reserved.

BladderScan, BladderScan i10, BladderScan Prime, BladderScan Prime Plus, BladderTraq, CaliScan, ImageSense, V_{MODE}, Verathon, and associated symbols are trademarks of Verathon Inc. All other brand and product names are trademarks or registered trademarks of their respective owners.

Not all Verathon Inc. products shown or described in this manual are available for commercial sale in all countries.

Information in this manual may change at any time without notice. For the most up-to-date information, see the documentation available at [verathon.com/service-and-support](https://www.verathon.com/service-and-support).

Table of Contents

- IMPORTANT INFORMATION 1**
- OVERVIEW 1
- Product Description..... 1
- Statement of Intended Use 1
- Notice to All Users 1
- Essential Performance..... 1
- Environments of Intended Use 1
- HIPAA Privacy 2
- SAFETY INFORMATION..... 2
- Ultrasound Energy Safety 2
- Contraindications 2
- Warnings & Cautions 2
- INTRODUCTION 9**
- SYSTEM OVERVIEW..... 9
- Components & Accessories..... 10
- SYSTEM FEATURES 12
- Console Features..... 12
- Probe Features 14
- Battery Features..... 15
- SYSTEM ICONS 15
- Console Touchscreen Icons..... 15
- Console Information Icons 18
- Battery Indicator LED Colors 19
- Console Battery Level Icons 20

SETTING UP	21
ASSEMBLING THE SYSTEM	21
<i>Procedure 1. Perform the Initial Inspection</i>	21
<i>Procedure 2. Assemble the Workstation and Attach the System</i>	22
<i>Procedure 3. Insert a Battery</i>	24
<i>Procedure 4. Charge the Battery</i>	26
<i>Procedure 5. Install the Printer (Optional)</i>	28
CONFIGURING SETTINGS	29
<i>Procedure 1. Configure General Settings</i>	29
<i>Procedure 2. Configure Administrative Settings</i>	31
<i>Procedure 3. Configure Exam Settings</i>	33
<i>Procedure 4. Configure Printed and PDF Report Settings</i>	34
<i>Procedure 5. Customize Cost Savings Calculations</i>	35
<i>Procedure 6. Configure a PIN for Saved Exams</i>	36
<i>Procedure 7. Configure a PIN for System Settings</i>	37
USING THE SYSTEM	38
MEASURING BLADDER VOLUME	38
<i>Procedure 1. Prepare for the Exam</i>	38
<i>Procedure 2. Input Patient Information or Operator ID (Optional)</i>	39
<i>Procedure 3. Use a Barcode Scanner to Enter a Patient or Operator ID (Optional)</i>	40
<i>Procedure 4. Measure Bladder Volume</i>	41
<i>Procedure 5. Review Exam Results</i>	43
<i>Procedure 6. Generate a Barcode containing an Exam Result</i>	47
<i>Procedure 7. Print, Save, or Exit an Active Exam</i>	48
<i>Procedure 8. View Cost Savings</i>	48
MANAGING SAVED EXAMS	49
<i>Procedure 1. Recall a Saved Exam</i>	49
<i>Procedure 2. Delete a Saved Exam</i>	50
<i>Procedure 3. Export Saved Exams</i>	51

REPROCESSING 52

- CLEANERS & DISINFECTANTS 52
 - Disinfection Efficacy 52
 - Compatibility 53
- BEST PRACTICES & INSTRUCTIONS 54
 - Procedure 1. Clean & Disinfect the Console, Probe, & Cable* 54
 - Procedure 2. Clean the Printer (Optional)* 55

MAINTENANCE & SAFETY 56

- REGULAR INSPECTIONS 56
- SYSTEM SECURITY INFORMATION 57
- CALIBRATION 57
- SYSTEM SOFTWARE 58
- DEVICE DISPOSAL 58
- WARRANTY 58
- MAINTENANCE PROCEDURES 59
 - Procedure 1. Load Thermal Paper into the Printer (Optional)* 59
 - Procedure 2. Run a Self-Test* 60
 - Procedure 3. Update the Software* 61
 - Procedure 4. Complete a CaliScan Test* 62
 - Procedure 5. Turn the System Off* 63
 - Procedure 6. Perform an Unconditional Shutdown* 64
 - Procedure 7. Copy the System’s Configuration to Other Systems* 65
 - Procedure 8. Turn the USB Ports On or Off* 67

HELP & TROUBLESHOOTING 68

- HELP RESOURCES 68
 - Procedure 1. Watch the Onboard Tutorial* 68
 - Procedure 2. Watch the Onboard Training Video* 69
- Customer Services Resources 69

DEVICE REPAIR	69
TROUBLESHOOTING PROCEDURES	70
<i>Procedure 1. Troubleshoot Console Battery Issues</i>	70
<i>Procedure 2. Troubleshoot Probe Connection Issues</i>	71
<i>Procedure 3. Troubleshoot Probe Aiming Issues</i>	71
<i>Procedure 4. Restore Factory Defaults</i>	73
<i>Procedure 5. Troubleshoot Irregular Printouts (Optional)</i>	74
<i>Procedure 6. Clear a Paper Jam (Optional)</i>	76
<i>Procedure 7. Replace the Printer Drive Roller (Optional)</i>	77
<i>Procedure 8. Evaluate Console Error Messages</i>	78
PRODUCT SPECIFICATIONS	80
SYSTEM SPECIFICATIONS	80
COMPONENT SPECIFICATIONS	83
ELECTROMAGNETIC COMPATIBILITY	88
ACCESSORY CONFORMANCE TO STANDARDS	91
GLOSSARY	92

Important Information

Overview

Product Description

The BladderScan i10 system provides noninvasive measurement of urinary bladder volume. The system calculates the bladder volume using ImageSense®, a proprietary Verathon artificial intelligence algorithm that draws on real-world data to create a consistent evaluation of the bladder's location, size, and shape.

The primary components of the system are a console and a probe. The console's touchscreen displays critical information such as bladder volume, directional aiming with real-time feedback, configuration and administrative settings, and indicators for battery level and charging status. The touchscreen also provides most of the system's controls, both during exams and between them. A clinician with appropriate access permission can use the touchscreen to retrieve stored exams at any time.

The console includes a bay for a rechargeable lithium-ion battery. When the console is connected to external power, it charges the battery.

Statement of Intended Use

The BladderScan i10 system is an ultrasound device intended to be used for measuring the urine volume in the bladder noninvasively.

Notice to All Users

The BladderScan i10 system should be used only by individuals who have been trained and authorized by a physician or the institution providing patient care. Users should read this entire manual before using the system. Do not attempt to operate the system until you thoroughly understand all instructions and procedures in this manual.

Essential Performance

Essential performance is the system performance necessary to avoid unacceptable risk. The essential performance of the BladderScan i10 system is to produce ultrasonic output energy, display ultrasonic images, and display numerical values for bladder volume. The system shall not produce unintended or excessive probe surface temperature.

Environments of Intended Use

The BladderScan i10 system is intended to be used in professional healthcare environments such as hospitals, clinics, and doctors' offices.

HIPAA Privacy

The Health Insurance Portability and Accountability Act of 1996 (“HIPAA”) regulations require our customers to monitor and limit the ways in which patients’ confidential information is accessed, used, stored, transmitted, and disposed of. Our customers are ultimately responsible for ensuring all electronic health information contained within the system is protected. In the course of providing services to customers, Verathon will remove any electronic protected health information from the system, if such information is still present.

Safety Information

Ultrasound Energy Safety

To date, exposure to pulsed diagnostic ultrasound has not been shown to produce adverse effects. However, ultrasound should be used prudently, and total patient exposure should be kept *as low as reasonably achievable* (ALARA). Following the ALARA principle, ultrasound should only be used by medical professionals when clinically indicated, using the lowest possible exposure times necessary to obtain clinically useful information. For more information on ALARA, refer to the American Institute of Ultrasound in Medicine publication, *Medical Ultrasound Safety*.

The ultrasound output power of the BladderScan i10 system is not user adjustable and is limited to the minimum level necessary for effective performance. For more information about acoustic output levels, see the chapter “[Product Specifications](#)” on page 80.

Contraindications

The BladderScan i10 system is not intended for fetal use or for use on fetal patients, pregnant patients, patients with open skin or wounds in the suprapubic region, or patients with ascites.

Warnings & Cautions

Warnings indicate that injury, death, or other serious adverse reactions may result from use or misuse of the system. *Cautions* indicate that use or misuse of the system may cause a problem, such as a malfunction, failure, or damage to the product. Throughout the manual, pay attention to sections labeled *Important*, as these contain reminders or summaries of the following cautions as they apply to a specific component or use situation. When using the system, heed the following warnings and cautions.

WARNINGS



WARNING

Do not use the system on:

- Fetal patients.
- Pregnant patients.
- Patients with open skin or wounds in the suprapubic region.
- Patients with ascites.



WARNING

Be aware of the following conditions that can affect ultrasound transmission:

- Catheterization—A catheter in the patient's bladder may affect the accuracy of the bladder volume measurement in two ways: 1) by introducing air into the bladder that may block the ultrasound signal, and 2) by having the catheter-retaining balloon interfere with the volume measurement. However, the volume measurement may still be clinically useful if it is large (detecting a blocked catheter, for example).
- Abdominal Surgery—Scar tissue, surgical incisions, sutures, and staples can affect ultrasound transmission. Use care when scanning patients who have had abdominal surgery.



WARNING

Accuracy is compromised if you do not obtain an optimal, repeatable image.



WARNING

Anatomical features surrounding the bladder can interfere with accurate scanning. When aiming the probe, ensure that the entire bladder is in view and centered.



WARNING

Do not use water or surgical lubricants as a substitute for ultrasound gel. Substituting these or other materials can cause incorrect scan results.



WARNING

This product may only be cleaned and disinfected by using the approved processes provided in this manual. Cleaning and disinfection methods listed are recommended by Verathon based on compatibility with component materials.



WARNING

Cleaning is critical to ensuring the component is ready for disinfection. Failure to properly clean the device could cause contamination to remain after the disinfection procedure is complete.



WARNING

When handling or disposing of the cleaning and disinfection products listed in this manual, be sure to follow the handling and disposal instructions provided by the manufacturers of those products.



WARNING

To reduce the risk of explosion, do not use the system in the presence of anesthetic substances that can catch fire if exposed to an existing fire or an electrical spark.



WARNING

To reduce the risk of electric shock or burns, do not use the system in conjunction with high-frequency surgical equipment.



WARNING

Do not use accessories, transducers, or cables other than those specified or provided by Verathon. Use of other such devices may cause this system to emit excessive electromagnetic energy or to pick up unwanted electromagnetic signals or noise from its surroundings. These malfunctions may cause improper operation, procedure delays, or both.



WARNING

Portable radio frequency communications equipment (including peripherals such as antenna cables and external antennas) may not be used within 30 cm (12 inches) of any part of the BladderScan system, including cables that Verathon specifies or provides for use with the system. If this distance is not maintained, performance of the system may be degraded and image display may be compromised.



WARNING

Use of this equipment adjacent to or stacked with other equipment should be avoided because it could result in improper operation. If such use is necessary, this equipment and the other equipment should be observed to verify that they are operating normally.



WARNING

To reduce the risk of leakage, explosion, fire, or serious injury, note the following when handling the lithium-ion battery included in the system:

- Remove the battery from the console if it is out of use for an extended period of time.
- Do not use the optional battery charger to charge the battery within 1.83 m (6 ft) of any patient, including the furniture containing the patient (such as a bed or exam table).
- Do not charge the battery in any area where oxygen is administered.
- Never short-circuit the battery by bringing the battery terminals into contact with any other conductive object.
- Never expose the battery to abnormal shock, vibration, or pressure.
- Use a general-purpose cleaner, such as an all-purpose spray cleaner or a cloth moistened with soap and water, to clean the battery. Do not clean or disinfect the battery using any of the cleaning or disinfection materials described in the Reprocessing chapter of this manual.
- Do not disassemble the battery, heat it above 60°C (140°F), or incinerate it.
- Keep the battery out of reach of children and in its original package until you are ready to use it.
- Dispose of used batteries promptly according to local recycling or waste regulations.
- If the battery is leaking or its case is cracked, put on protective gloves to handle it, and discard it immediately.
- Put insulating tape, such as cellophane tape, on the electrodes during transportation.



WARNING

To maintain electrical safety, use only the battery, power adapter, and power cord supplied with the system. Use only Verathon-recommended accessories and peripherals, including the accessory battery charger.



WARNING

To reduce the risk of electrical shock, do not attempt to open the system components. This may cause serious injury to the operator or damage to the system and will void the warranty. Contact Verathon Customer Care or your local representative for all servicing needs.



WARNING

To maintain electrical safety, inspect the power adapter for damage before each use. Do not use a power adapter with cracks, broken wiring insulation, or other damage. If the power adapter is damaged, contact Verathon Customer Care or your local representative.



WARNING

To maintain electrical safety, if you are using the accessory battery charger, inspect the charger for damage before each use. Do not use a battery charger with cracks or other damage. If the battery charger is damaged, contact Verathon Customer Care or your local representative.



WARNING

If the battery is overheating or drawing excessive current, turn the system off and disconnect external power immediately. Allowing overheating or excess current draw to continue can start a fire or cause an electrical injury. For help with battery malfunctions, contact Verathon Customer Care.



WARNING

Apart from settings that can be configured through the system's software menus, no mechanical, electrical, or acoustic modification of this equipment is allowed.



WARNING

To avoid the risk of injury, when the printer door is open:

- Do not touch the printer mechanism or print head, which may be hot from recent printing.
- Do not touch the edge of the paper cutter.



WARNING

Never use the BladderScan i10 system to display the image of anatomical features other than the bladder.



WARNING

This system is intended as a measuring tool only. It is not a diagnostic device.



WARNING

Use only a passive-type USB flash drive. Do not use USB drives powered by another external source.

CAUTIONS



CAUTION

Statement of Prescription: Federal (United States) law restricts this device to sale by or on the order of a physician.



CAUTION

Before scanning a patient, make sure that a battery is installed and properly charged. The system cannot scan while connected to external power.



CAUTION

To avoid damage to cables and accessories, do not excessively twist or bend cables associated with the system.



CAUTION

To dispose of the system or accessories at the end of their useful service life, see the section “Device Disposal”. The system and related devices may contain mineral oils, batteries, and other environmentally hazardous materials.



CAUTION

Before you perform any system upgrade, self-test, or maintenance procedure, make sure that a battery is installed and charged to a level of at least 20%. Disconnect external power before performing a system upgrade.



CAUTION

Medical electrical equipment requires special precautions regarding electromagnetic compatibility (EMC) and must be installed and operated according to the instructions in this manual. For more information, see the “Electromagnetic Compatibility” section.

This device can radiate radio frequency energy and is very unlikely to cause harmful interference with other devices in the vicinity. There is no guarantee that interference will not occur in a particular installation. Evidence of interference may include degradation of performance in this device or other devices when operated simultaneously. To correct interference, use the following measures:

- Turn devices on and off in the vicinity to determine the source of interference.
- Reorient or relocate this device or other devices.
- Increase the separation between devices.
- Connect the device to an outlet on a circuit different than the other device(s).
- Eliminate or reduce EMI with technical solutions (such as shielding).
- Purchase medical devices that comply with the IEC 60601-1-2 standard.
- Be aware that portable and mobile radio frequency communications equipment (cellular phones, etc.) may affect medical electrical equipment; take appropriate precautions during operation.



CAUTION

Failure to follow these instructions may cause device damage not covered by the warranty:

- Do not immerse any system component in cleaning or disinfectant solution or other liquids.
- Do not subject any system component to steam, ethylene oxide, radiation, or similar methods of sterilization or autoclaving.
- Do not use metal or abrasive brushes. These may scratch a component of the system, causing permanent damage.

Introduction

System Overview

BladderScan i10 is a 3D ultrasound system that measures bladder volume noninvasively. The core components of the system are a console with a touchscreen display and a probe containing the ultrasound transducer. The system also includes a rechargeable battery. Available accessories and configuration options for the system include a mobile workstation, a printer, an external battery charger, and extra rechargeable batteries. For more information, see “[Components & Accessories](#)” on page 10.

Figure 1. BladderScan i10 System (Showing Accessory Printer and Workstation)



The system includes an onboard tutorial as well as integrated help screens. The console features a variety of customizable settings and a Saved Exams function that allows you to recall, print, or transfer saved exams.

The console also features an optional live imaging pre-scan mode that enables you to locate the bladder by displaying a B-mode view of the abdomen in real time, before completing the volume measurement scan.

Components & Accessories

Table 1. Included System Components & Accessories

INCLUDED SYSTEM COMPONENTS & ACCESSORIES



Console



Probe



Battery



In-service USB flash drive



Power adapter



Power cord

Note: Plug may vary by region



Ultrasound gel packets

Table 2. Optional System Components & Accessories

OPTIONAL SYSTEM COMPONENTS & ACCESSORIES



Mobile Workstation



Battery Charger



Extra Battery



Printer

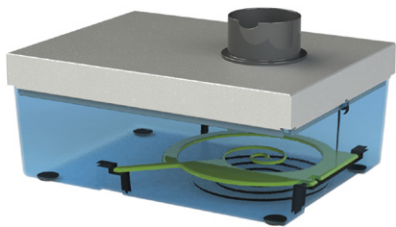

Calibration Kit



Barcode Scanner



Thermal Paper

Additionally, quick reference materials and ultrasound gel may be available for order in your region. For more information, contact Verathon Customer Care or your local representative or visit verathon.com/service-and-support.

System Features

Console Features



Read the “Warnings & Cautions” section before using the system.

The console’s primary feature is a touchscreen display that allows you to perform scans, manage scan results, and customize settings. A rechargeable battery is inserted into one side of the console, and the bottom surface includes a selection of ports for connecting system components and accessories such as external, removable media storage devices. You may also customize your console by adding an optional printer.

Figure 2. Console Features

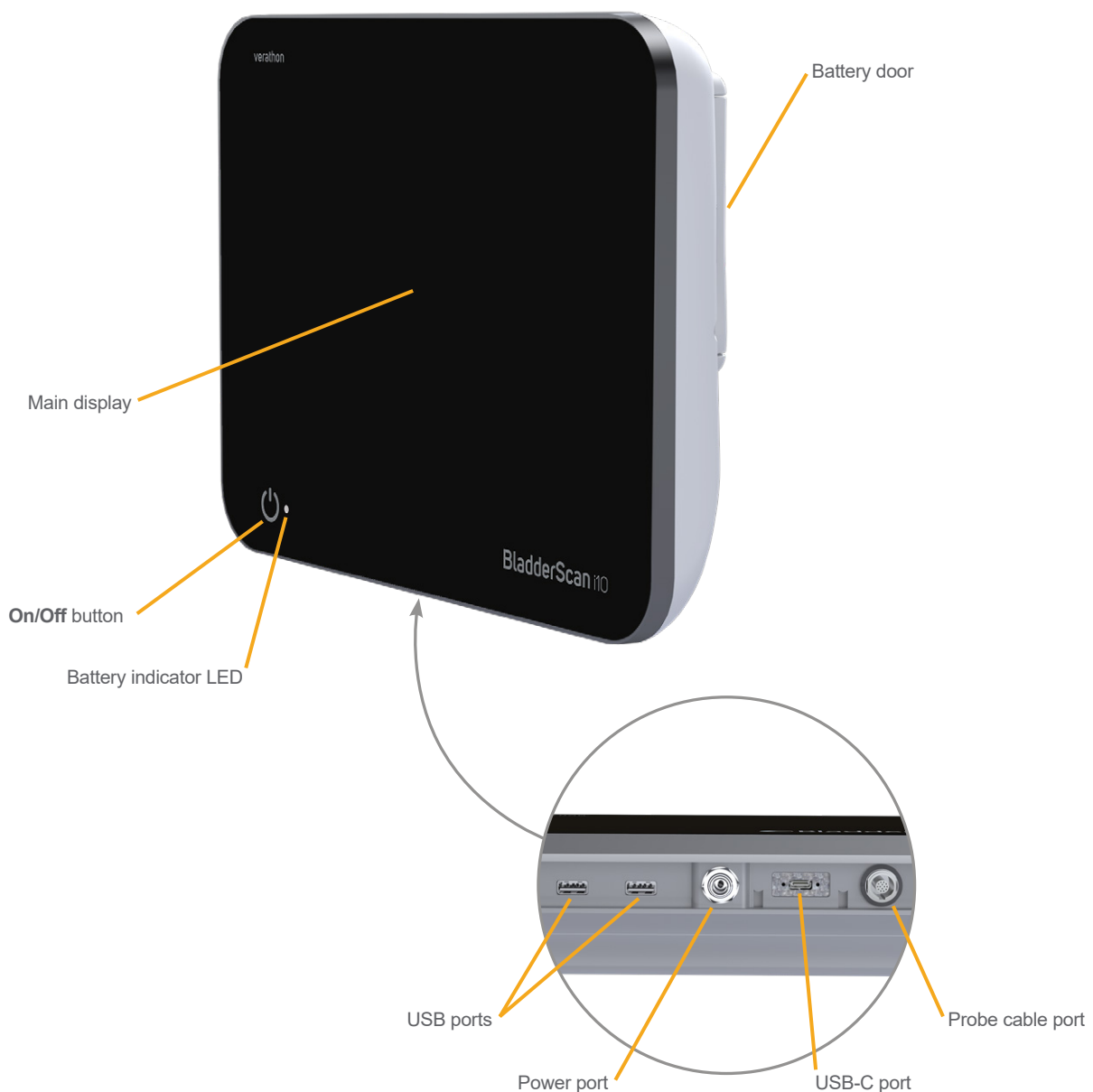

Table 3. Console Feature Descriptions

PART NAME	PURPOSE
Main display	Features touchscreen controls of the system user interface.
Battery door	Opens to access and replace the rechargeable battery.
On/Off button	Turns the system on or off. When the system is turned on or charging a battery, an LED next to the On/Off button is illuminated.
Probe cable port	Connects the probe to the console.
USB ports	Provides a connection for the optional printer and for external, removable storage media.
USB-C port	Provides a connection for external, removable storage media.
Power port	Connects the power adapter to the console.

IMPORTANT

If you press the **On/Off** button and hold it for more than two seconds, the console starts an unconditional shutdown process. Under some circumstances, this process can result in the loss of unsaved information.

Probe Features

The probe contacts the patient and transmits and receives ultrasound waves, automatically moving its internal transducer to scan twelve planes to produce a three-dimensional image of the bladder. The probe is attached to the console by a cable.

Figure 3. Probe Features

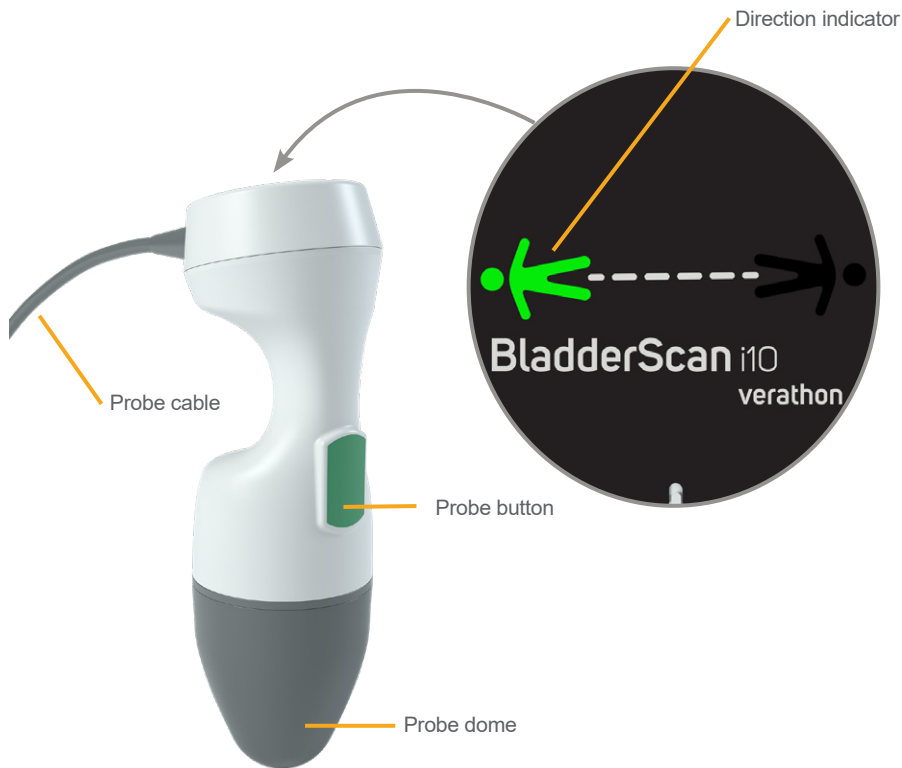

Table 4. Probe Features

PART NAME	PURPOSE
Probe button	Starts aiming or scanning when pressed.
Direction indicator	Displays the probe orientation selected for the current scan. The lighted human figure indicator should be oriented in the same direction as the patient.
Probe cable	Connects the probe to the console.
Probe dome	Contacts the patient's abdomen and transmits ultrasound.

Battery Features

The system is powered by a lithium-ion battery. Additional or replacement batteries can be ordered if needed.

The BladderScan i10 console serves as the main battery charger. To charge a battery, the console must be connected to a wall outlet using the power adapter and power cord provided. Use only the console or the optional Verathon battery charger to charge the battery; any other battery charger may damage it. To prevent incorrect connections, the battery is shaped so that it can be inserted into the console in only the correct orientation.

The console automatically detects whether or not it is connected to external power. While the console is connected, it deactivates the probe's scanning functions.

Each battery features a test button that allows you to check the charge level of the battery without inserting it into the console. If you press the **Test** button on the back of the battery, the display next to the test button illuminates to display the approximate charge level: 25%, 50%, 75%, or 100%.

Figure 4. BladderScan i10 Lithium-Ion Battery



















System Icons

















Console Touchscreen Icons

The console touchscreen displays the interface that controls the system. The icons in Table 5 may appear on the screen, and you may tap them to complete the function associated with the icon.

Table 5. Touchscreen Icons

ICON	FUNCTION
	Saved Exams —On the Home screen, view all exams that are saved to the console.
	Settings —On the Home screen, open the Settings screen.
	Tutorial —On the Home screen, view the onboard tutorial.
	Training Video —On the Home screen, view the onboard training video.



ICON	FUNCTION
	Position —On the Home screen, select which side of the patient you are located on during the exam.
	Scan —Start scanning the patient.
	B-Mode —View the ultrasound image as pairs of two-dimensional, orthogonal planes from the three-dimensional scan. The contours of detected features are overlaid on the image. <i>Note: You may disable the display of the detected contours. For more information, see “Configure Exam Settings” on page 33.</i>
	C-Mode —View the ultrasound image as a cross-section view of the three-dimensional scan. The C-Mode image consists of a circular region with a crosshair overlay. This image displays the bladder shape and, if detected, the shadow of the pubic bone.
	Aztec Code —Display a summary of the scan results as an Aztec code (with the positioning square in the center).
	Code 128 —Display a summary of the scan results as a barcode in Code 128 format.
	Data Matrix —Display a summary of the scan results as a Data Matrix.
	QR Code —Display a summary of the scan results as a QR code (with positioning squares at the corners).
	Delete —On the Results screen, delete the displayed scan and its volume. (The system retains all other scans and all patient information.) On the Saved Exams screens, delete a saved exam (either the currently displayed exam or an exam selected in a list).
	Help —Start the onboard tutorial or display screen-sensitive help text.
	Print —Print the scan, self-test, or savings calculation results. <i>Note: This function is only available if you have attached the optional printer.</i>
	Save and Exit —On the Results screen, save the scan result with the largest volume and return to the Home screen.
	Export Exams —On the Saved Exams screen, move exams from the system’s internal memory to an external USB drive. This option is only available if an external drive is connected.
	Configure Savings —Customize the values for calculating the cost savings that result from scanning rather than catheterizing patients.
	CaliScan™ —On the Self-Test screen, perform a functional test of the system’s probe mechanism and ultrasound transducer.
	Back —Return to the previous screen or the Home screen.

ICON	FUNCTION
	Exit —On the Results screen, exit the exam without saving and return to the Home screen.
	Previous —While viewing B-mode images on the Results screen, return to the previous scan plane or angle.
	Next —While viewing B-mode images on the Results screen, advance to the next scan plane or angle.
	Brightness —Adjust the brightness of the touchscreen. The icon shows the current setting.
	Volume —Adjust the volume of sounds played through the console's speaker. The icon shows the current setting.
	Increase —Turn up the brightness or volume.
	Decrease —Turn down the brightness or volume.
	Mute —Turn the speaker on or off.
	Play —While viewing the onboard tutorial or the training video, start or resume playback.
	Pause —While viewing the onboard tutorial or the training video, pause playback.
	Previous —While viewing the onboard tutorial, return to the previous frame.
	Next —While viewing the onboard tutorial, advance to the next frame.
	Skip Ahead —While viewing the onboard training video, move forward 5 seconds.
	Skip Back —While viewing the onboard training video, move back 5 seconds.
	On the Results screen, expand the history list of scans taken during the current exam.
	On the Results screen, close the history list of scans taken during the current exam.
	Close the Barcode window or a warning dialog box.

Console Information Icons

The icons in Table 6 provide information about the status of the system, but tapping them does not affect the system.

Table 6. Information Icons

ICON	FUNCTION
	The printer is charging, but it does not have enough charge left in its built-in internal battery to operate correctly.
	The printer cannot operate because of a problem with its built-in internal battery.
	Note the accompanying alert.

Battery Indicator LED Colors



WARNING

If the battery is overheating or drawing excessive current, turn the system off and disconnect external power immediately. Allowing overheating or excess current draw to continue can start a fire or cause an electrical injury. For help with battery malfunctions, contact Verathon Customer Care.







The battery indicator LED next to the **On/Off** button  shows the current condition of the console's battery. Except in cases where the battery is overheating or drawing excessive current, the LED displays the battery's current charge level.

The system charges the battery whenever it is connected to external power. If the system is on at the same time, the battery cannot quite reach full charge, so the system charges it continuously. If the system is connected to external power but is turned off, it stops charging once the battery is fully charged.

Table 7 shows how the battery indicator LED reports the condition of the battery based on whether the system is connected to external power and whether it is turned on or off.

Note: Status indicators that do not state a charge level apply at any charge level. If the system is off and not connected to external power, the LED is always unlit.

Table 7. Battery Indicator LED Colors

COLOR	CONNECTED TO EXTERNAL POWER		NOT CONNECTED TO EXTERNAL POWER
	System On	System Off	System On
Flashing red 	—	—	System may shut down soon due to excessive battery temperature
Steady red 	Less than 2%, or no battery present	—	Greater than or equal to 5%, less than 10%*
Flashing blue 	Excessive battery temperature or excessive current while charging	Excessive battery temperature, excessive current while charging, or no battery present	—
Steady blue 	—	Greater than or equal to 2%, less than 99%	—
Steady yellow 	Greater than or equal to 2%, less than 20%	—	Greater than or equal to 10%, less than 20%
Steady green 	Greater than or equal to 20%	—	Greater than or equal to 20%
Unlit 	—	Greater than or equal to 99%†	—











* Note: If the system is on but not connected to external power, and the battery level is less than 5%, the system attempts to shut itself down automatically. During the automatic shutdown, the battery indicator LED remains red.

† Note: If you insert a battery that is completely depleted and then connect external power to the console, the battery indicator LED remains unlit. In such cases, the battery is not charged enough for the console to detect it. Press the **On/Off** button to begin charging the battery.

Console Battery Level Icons

The battery level icon is displayed in the status bar at the top of the touchscreen. The icon and the percentage value next to it indicate the remaining battery power. For information about charging the battery, see the procedure “[Charge the Battery](#)” on page 26.

Table 8. Battery Level Icon

ICON	FUNCTION
	The battery is fully or almost fully charged.
	The battery is approximately 80% charged.
	The battery is approximately 60% charged.
	The battery is approximately 40% charged.
	The battery is approximately 20% charged. Replace with a fresh battery or connect external power.
	The battery is approximately 10% charged. Replace with a fresh battery or connect external power.
	The battery is less than 5% charged. Replace the battery or connect external power immediately. At this point, the system turns itself off if external power is not connected. If external power is connected, the system software may be temporarily unable to detect the battery while charging begins.
	The battery is not present, or it cannot be detected because its charge level is too low (less than 2%). If external power is connected, the LED next to the On/Off button  is red instead of yellow or green. If you turn the system off under these conditions, the LED flashes blue and the system continues to charge the battery.
	The battery is charging.

Setting Up

To help you get started, these topics explain how to assemble the system:

1. [Perform the Initial Inspection](#)
2. [Assemble the Workstation and Attach the System](#)
3. [Insert a Battery](#)
4. [Charge the Battery](#)
5. [Install the Printer \(Optional\)](#)

Once the system is assembled, you can configure user settings and add custom information:

6. [Configure General Settings](#)
7. [Configure Administrative Settings](#)
8. [Configure Exam Settings](#)
9. [Configure Printed and PDF Report Settings](#)
10. [Customize Cost Savings Calculations](#)
11. [Configure a PIN for Saved Exams](#)
12. [Configure a PIN for System Settings](#)

Assembling the System

Procedure 1. Perform the Initial Inspection

When you receive the system, Verathon recommends that an operator familiar with the system perform a full visual inspection for any physical damage that may have occurred during shipment. If the system includes any optional components, be sure to include them in this inspection.

1. Carefully open the top of the shipping box. Do not insert anything sharp through the box.
2. Remove the contents and verify that you have received the appropriate components for your system.
3. Inspect the components for damage.
4. If any of the components are missing or damaged, notify the carrier and Verathon Customer Care or your local representative.

Procedure 2. Assemble the Workstation and Attach the System

Refer to the *BladderScan i10 Workstation Assembly Quick Start Sheet* (part number 0900-5007) for instructions on how to perform these tasks:

- Assemble the workstation
- Install the power adapter in the workstation
- Install the printer (if you have purchased the printer along with the system)

For instructions on how to install an optional barcode scanner, refer to the *Barcode Scanner Kit Quick Start Sheet* (part number 0900-5161).

This procedure describes how to mount the console on an assembled workstation.

1. Position the console in front of the console mount on the workstation.
2. Insert four console mounting screws (part F in the hardware kit shipped with the workstation) through the holes at the corners of the console mount and into the corresponding holes on the workstation. Finger-tighten all four screws securely.

Note: The console mount on the workstation uses a combination of spring tension and friction to maintain the position of the console. It can be adjusted without tools at any time.

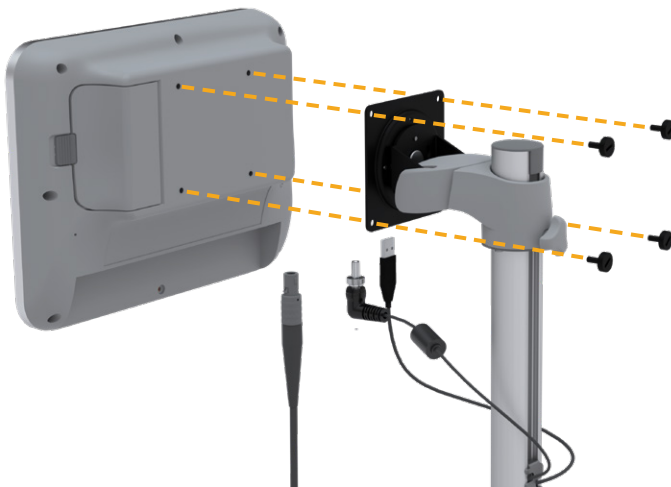

3. Connect the probe cable, the power cable, the optional USB printer cable, and the optional barcode scanner cable to the console as shown in the following figure. Make sure the power cable connector is seated securely and finger-tighten its locking collar firmly.

*Note: **Do not** use tools to attach or remove the connectors.*

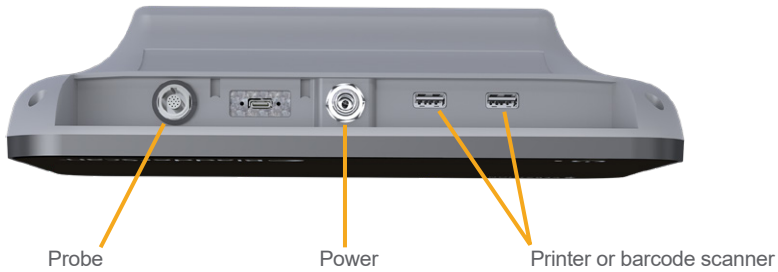

Tip: You can connect the printer to either of the USB ports indicated in the figure. However, connecting it to the USB port closest to the power port makes it easier to connect USB drives or a barcode scanner later. Do not attempt to connect the printer to the USB-C port between the probe port and the power port.

Procedure 3. Insert a Battery

1. Slide the latch away from the battery well door on the console, and then open the door.



2. Move the door away from the battery well.



3. If a battery is already in the console, remove it by pulling the strap.

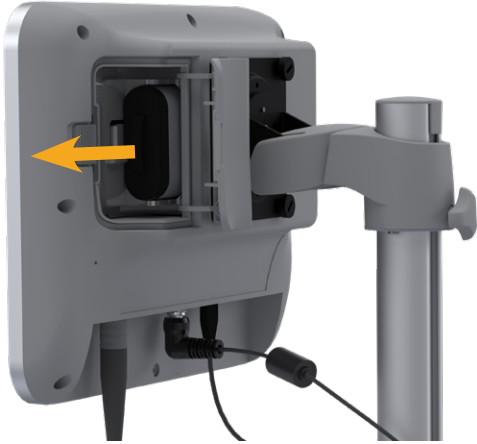

4. Slide a charged battery into the battery well with the Verathon logo facing the back of the console, and then push gently until the battery is completely seated.

Note: The battery is designed to prevent incorrect installation. If the battery does not slide into the battery well easily, remove the battery, reorient it, and try again. Do not attempt to force the battery into position.



5. Close and latch the battery well door.

Procedure 4. Charge the Battery



Read the “Warnings & Cautions” section before performing the following task.

One lithium-ion battery is included with the system. Before using the system for the first time, you must fully charge the battery.

Option 1. Charging the Battery in the Console

IMPORTANT

The probe does not operate when the system is connected to external (mains) power. To scan patients, the console must have a charged battery and the system must be unplugged from external power.

1. Before each use, inspect the battery, the power adapter, and the power cord for damage. If a component is damaged, do not use it. Contact Verathon Customer Care or your local representative.
2. Make sure the power cable is securely connected to the console.
3. Plug the power adapter into a standard wall outlet. Make sure the power cord can be easily disconnected if necessary.
4. If the battery indicator LED on the console remains unlit, press the **On/Off** button . The LED should light up to indicate that the battery is charging.
5. Allow the battery to charge completely. The first charge should take about 4 hours.

Option 2. Charging with the External Charger (Optional)

1. Before each use, inspect the battery charger, the battery or batteries, the power adapter, and the power cord for damage. If a component is damaged, do not use it. Contact Verathon Customer Care or your local representative.
2. Connect the power adapter to the power cord.



3. Connect the power adapter to the battery charger.



4. Plug the power adapter into a standard wall outlet. Make sure the power cord can be easily disconnected if necessary.
5. Insert one or two batteries into the recesses in the battery charger. If you are charging two batteries for the first time, charge both batteries at the same time for best results.

Note: To ensure that each battery is properly connected to the charger, make sure that its Verathon logo and its contacts face right as seen from the front of the charger.



6. Allow the battery to charge completely. The indicator lights on the battery charger indicate the status of each battery:
 - Green solid—Battery is fully charged
 - Green flashing—Battery is charging
 - Yellow solid—Battery charging is suspended or in standby mode
 - Red—Charging error. Contact Verathon Customer Care or your local representative.
 - Off—No battery detected

Procedure 5. Install the Printer (Optional)

An optional printer is available for BladderScan i10 systems. This printer is mounted on the base of the workstation and communicates with the console through a standard USB connection.

If your organization has purchased the printer as part of its initial BladderScan i10 system order, follow the instructions in the *BladderScan i10 Workstation Assembly Quick Start Sheet* (part number 0900-5007) to install the printer as you assemble the workstation.

If your organization purchases a printer for an existing BladderScan i10 system, follow the instructions in the *BladderScan i10 Printer Installation Quick Start Sheet* (part number 0900-5068) to add the printer to the workstation and install the USB cable between the console and the printer.

Configuring Settings

The system is configured with default settings that are appropriate for many users. This section contains instructions for modifying the settings for your facility's needs.

Procedure 1. Configure General Settings

This procedure helps you configure your regional and facility preferences, such as an asset tag for your system, the language in which the system operates, and your formatting preferences for the time, date, currency, and numbers.

1. If necessary, press the **On/Off** button . After a few seconds, the console displays the Home screen.
2. On the Home screen, tap **Settings**. The Settings screen opens to the General tab.

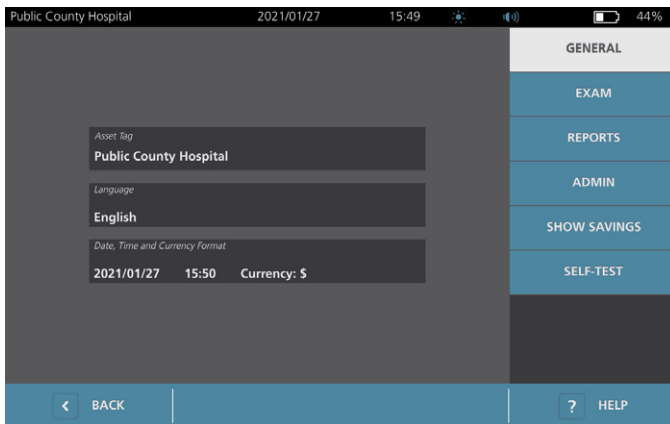

3. On the General tab, tap **Asset Tag**.
4. If a keypad appears, key in the PIN for Settings, and then tap **Enter**.
5. Use the virtual keyboard to type an identifying name or number, and then tap **Enter**. The text you entered is displayed on the status bar at the top of each screen.



6. If you would like to change the language in which the system operates and exams are saved, tap **Language**.

7. If a keypad appears, key in the PIN for Settings, and then tap **Enter**.
8. On the Language screen, select an available option. The language updates immediately.
9. Tap **Back** to return to the Settings screen, and then tap **Date, Time and Currency Format**.
10. If a keypad appears, key in the PIN for Settings, and then tap **Enter**.
11. On the Date, Time and Currency screen, in the **Time** field, tap the hour or minutes. Swipe vertically to locate a value, and then tap the value to select it.



12. In the **Time** field, tap the time format. The time format scrolls through AM, PM, and 24-hour displays. If you select a new time format, the hours and minutes values are updated as necessary.
13. In the **Date** field, tap the month, day or year, vertically swipe to view a value, and then tap the value to select it. Repeat as needed to set the desired month, day, and year.
14. In the **Date Format** field, tap the arrow, and then select the month, day, and year display order. The Date field immediately updates to display the selected format.
15. In the **Savings Currency** field, tap the arrow and then select the desired currency. This unit is used when displaying savings as a result of using the BladderScan system instead of catheterization.
16. In the **Number Format** field, tap the arrow to select the display format for numeric fields.
17. When you are finished configuring the Date, Time, and Currency settings, tap **Back** twice. This saves your settings and returns the console to the Home screen.

Procedure 2. Configure Administrative Settings



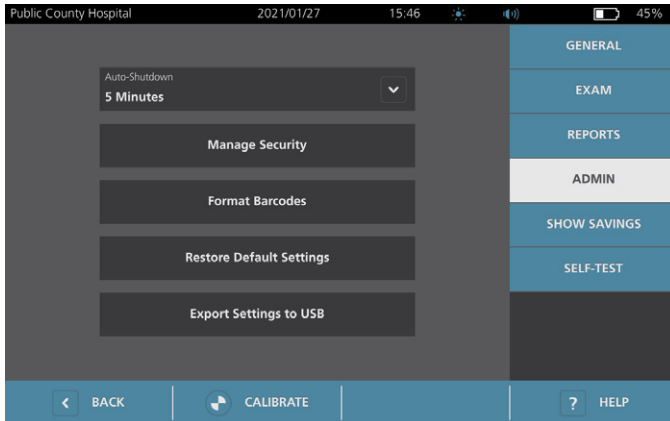

1. On the Home screen, tap **Settings**, then **Admin**.
2. If a keypad appears, key in the PIN for Settings, and then tap **Enter**.

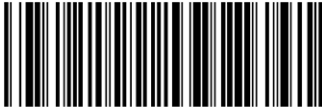

3. On the Admin tab, in the **Auto-Shutdown** field, tap the arrow and then select the number of minutes the system should remain on but inactive before it turns itself off.

Note: If an exam is in progress when automatic shutdown begins, the system saves the exam results.

4. If you want to define the type of barcode the system should use to display exam results, tap **Format Barcodes**.
5. From the Format Symbology list, select one of the following barcode types.

SYMBOL TYPE	EXAMPLE
Code 128	
Data Matrix	
QR Code	
Aztec Code	

6. From the Encoded Value list, select the amount of information to include in the barcode for each exam. Where the selection allows it, a > symbol precedes the measured volume if the bladder extends outside the scan area or if the pubic bone obstructs a portion of the bladder.

SELECTION	INFORMATION INCLUDED	EXAMPLE
Full Exam Notes	A short phrase containing the measured volume (including the > symbol if needed), the date, the time, and the identity of the system that created the scan	200 mL of urinary bladder volume recorded at 2:33 PM, 2020/04/22.
Volume & Edge/Interference	The measured volume in mL (including the > symbol if needed)	200 mL
Volume Number Only	A number representing the measured volume in mL. This selection allows numeric digits only, so the > symbol is not included.	200

Note: The Full Exam Notes option is not available if the Code 128 format is selected.

7. From the Prefix and Suffix boxes, select the control characters that the system should add before and after the information:
 - **Backslash**
 - **Carriage Return**
 - **Line Feed**
 - **Carriage Return & Line Feed**
 - **Tab**
 - **None**

If necessary, contact the administrator of your facility's EHR or EMR system to verify what control characters the system needs.

8. When you are finished configuring settings, tap **Back** twice. This saves your settings and returns the console to the Home screen.

Procedure 3. Configure Exam Settings

You may configure these exam settings:

- Display of B-Mode images
- Live B-mode aiming
- Time-out interval for the live B-mode aiming feature
- Bladder outline on B-mode images
- Display of exam results in barcode format
- Assignment of an automatically generated patient ID number at the beginning of each exam

1. On the Home screen, tap **Settings**, and then tap **Exam**.
2. If a keypad appears, key in the PIN for Settings, and then tap **Enter**.
3. On the Exam tab, tap the field to update, and then if applicable, select or type the new value:
 - **Enable Live B-Mode Aiming**—Activates a real-time, B-mode ultrasound preview of the bladder before the scan to provide aiming assistance.
 - **Inactivity Timeout**—Defines the amount of time that live B-mode aiming is active. Once the timeout period has been reached, the system returns to the Home screen. This setting is only visible if live B-mode aiming is enabled.
 - **Enable B-Mode Plane Images**—Allows the display of B-mode images in active and saved exams.
 - **Enable On-Screen Barcode**—Displays a patient’s exam results as a barcode, in addition to the readable numbers the system normally displays.
 - **Enable BladderTraq™ Outline**—On B-mode images, displays a green outline around the detected edges of the bladder.
 - **Assign Patient ID Automatically**—Automatically generates a new patient ID for each exam. You can replace this ID at the beginning of an exam, as described in the section “[Input Patient Information or Operator ID \(Optional\)](#)” on page 39.

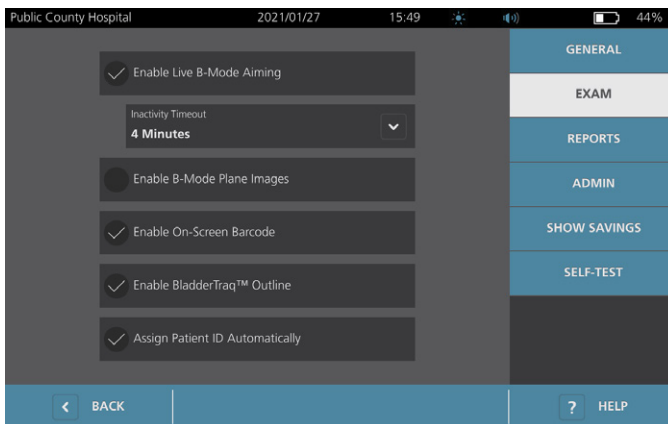

4. When you have finished, tap **Back**. This saves your settings and returns the console to the Home screen.

Procedure 4. Configure Printed and PDF Report Settings

If a printer is attached to the console, you can print scan results. Reports are printed vertically, like a receipt. Scan reports are made up of a number of sections. Some of the sections are optional.

You can also export saved exams to an external USB drive. For information on exporting exams, see “Export Saved Exams” on page 51.

You can customize which sections and B-mode images are included in reports, regardless of whether they are printed or exported in PDF format.

1. On the Home screen, tap **Settings**, and then tap **Reports**.
2. If a keypad appears, key in the PIN for Settings, and then tap **Enter**.

The Settings screen opens to the Reports tab.

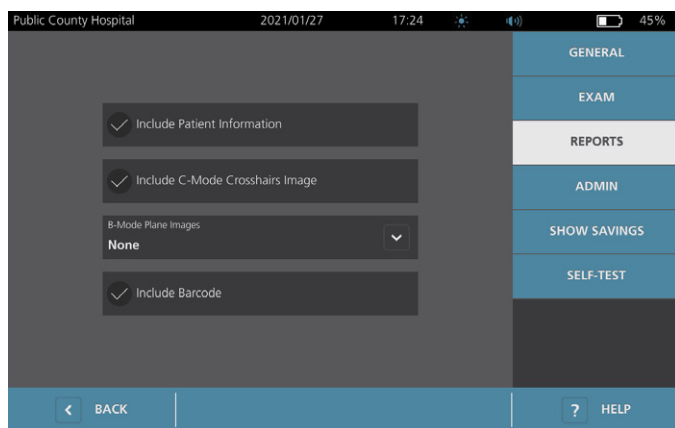

3. Tap the information to include in reports. If a check mark is displayed to the left of the information description, the following information is printed:
 - **Include Patient Information**—Select to include patient data, such as patient ID or date of birth.
 - **Include C-Mode Crosshairs Image**—Select to include the coronal view image computed by the system. The aiming circle and crosshairs are printed as black lines.
 - **B-Mode Plane Images**—Select one of the following groups of images to include in printed and exported reports:
 - **None**—Select to include no B-mode image planes.
 - **All**—Select to include all 12 B-mode image planes.
 - **Sagittal & Transverse**—Select to include the two primary B-mode image planes.
 - **Include BladderTraq™ Outline**—Select to add outlines of the bladder’s internal contours to the B-mode image.
 - **Include Barcode**—Select to include the exam’s final volume measurement as a barcode.
4. When you are finished configuring the printed report settings, tap **Back**. This saves your settings and returns the console to the Home screen.

Procedure 5. Customize Cost Savings Calculations

The system provides default values for calculating the cost savings that result from scanning rather than catheterizing patients. The default settings can be customized to reflect the rates and costs at your facility. To change the currency used for cost savings calculations, see “Configure General Settings” on page 29.

Total cost savings from using the system are based on this formula:

$$\text{Total cost savings} = (\text{Catheterizations avoided} \times \text{Catheterization costs}) + (\text{UTIs avoided} \times \text{UTI costs})$$

1. On the Home screen, tap **Settings**, and then tap **Show Savings**.
2. On the Show Savings tab, tap **Configure Savings**.

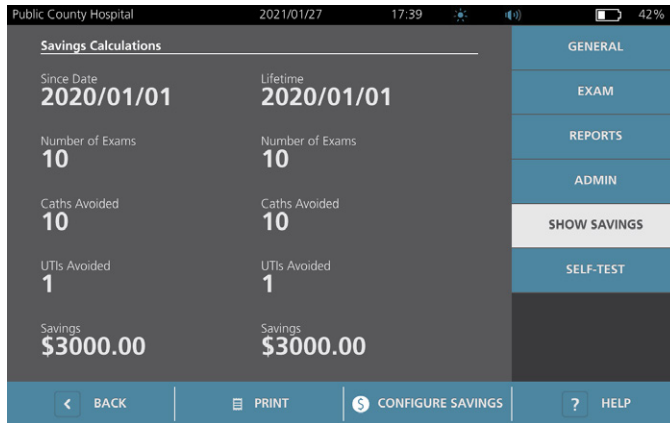

3. On the Configure Savings screen, tap a field to update, and then enter new values. Numeric fields accept decimal input but round to the nearest whole number.
 - **UTI Rate**—Select the rate of urinary tract infections (UTIs) resulting from catheterizations.
 - **UTI Cost**—Select the cost per UTI at your facility.
 - **Catheterization Cost**—Select the cost per catheterization procedure.
 - **Catheterization Volume**—Select the volume threshold for catheterization. Scans below the volume threshold are not used in cost savings calculations.

Note: The Reset Calculations button restarts savings calculations as of the date this button is selected. Tapping this button is not required to update savings values.

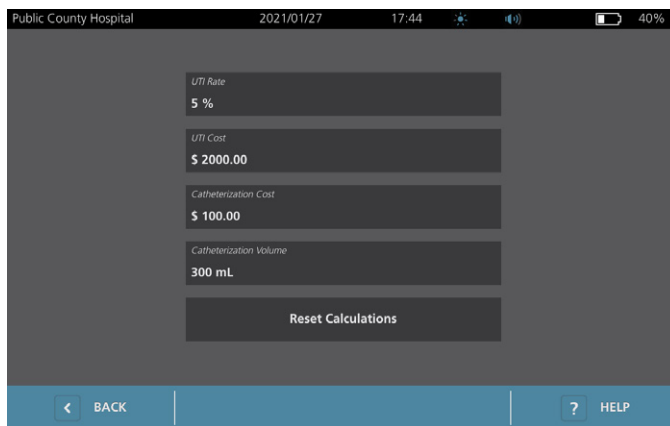

4. When you are finished, tap **Back** twice. This saves your settings and returns the console to the Home screen.

Procedure 6. Configure a PIN for Saved Exams

If it is necessary to restrict access to saved patient and exam information, you can create a PIN to protect that information. After you create the PIN, the system does not display saved exams unless the PIN is entered. Deleting the PIN deactivates this requirement.

If you need to change the PIN, you must enter the existing PIN before you create the new one.

Note: For recommendations on how to use PINs for the best possible security, see “System Security Information” on page 57.

1. At the Home screen, tap **Settings**.
2. At the Settings screen, tap the **Admin** tab.
3. If a keypad appears, key in the PIN for Settings, and then tap **Enter**.

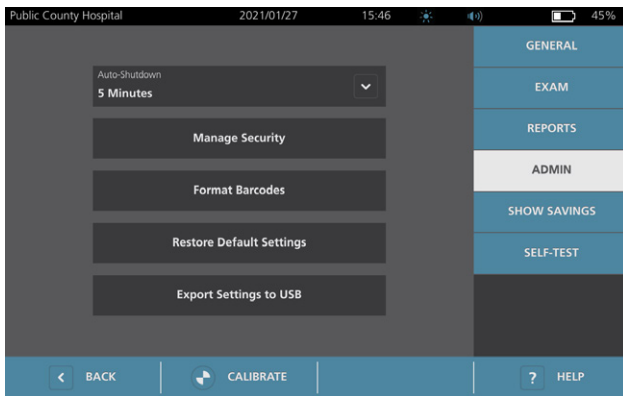

4. On the Admin tab, tap **Manage Security**.
5. In the Manage Security dialog box, tap **Change PIN for Saved Exams**.
6. Tap the **Enter New Saved Exams PIN** box. Using the keypad, key in the new 4-digit PIN required for access to saved exams on the system, and then tap **Enter**.

Alternatively, to deactivate the PIN for Saved Exams, tap **Clear** to remove any digits that have already been entered. Save the change by tapping **Enter**.

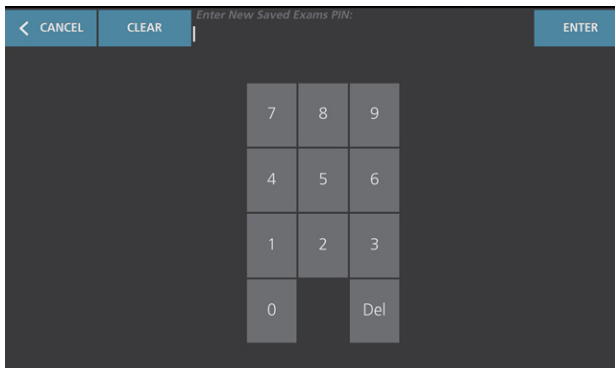

7. Tap the **Confirm New Saved Exams PIN** box, and then enter the same code you entered previously.
8. Tap **Save PIN for Saved Exams**.

Procedure 7. Configure a PIN for System Settings

If it is necessary to ensure that system configuration settings are consistent throughout your organization, you can create a PIN to restrict people from changing the settings on the Admin, Exam, and Reports tabs or resetting the system to factory defaults. Deleting the PIN for Settings makes these items available to anyone.

If you need to change the PIN for Settings, you must enter the existing PIN before you create the new one. If you have forgotten the existing PIN, contact Verathon Customer Care for assistance in clearing it.

Note: For recommendations on how to use PINs for the best possible security, see “System Security Information” on page 57.

1. At the Home screen, tap **Settings**.
2. At the Settings screen, tap the **Admin** tab.
3. If a keypad appears, key in the PIN for Settings, and then tap **Enter**.

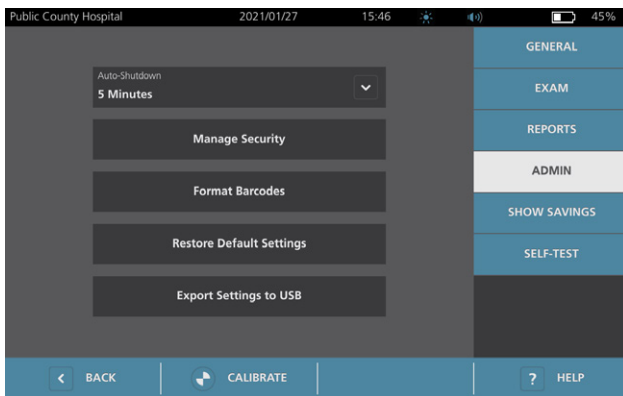

4. On the Admin tab, tap **Manage Security**.
5. In the Manage Security dialog box, tap **Change PIN for Settings**.
6. Tap the **Enter New Settings PIN** box. Using the keypad, key in the new 4-digit PIN required for access to system settings, and then tap **Enter**.

Alternatively, to deactivate the PIN for Settings, tap **Clear** to remove any digits that have already been entered. Save the change by tapping **Enter**.

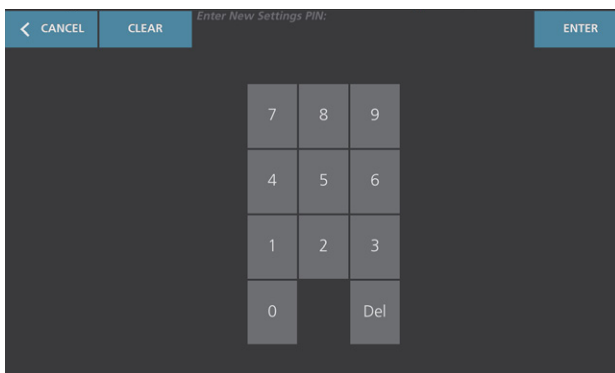

7. Tap the **Confirm New Settings PIN** box, and then enter the same code you entered previously.
8. Tap **Save PIN for Settings**.

Using the System



Read the “[Warnings & Cautions](#)” section before performing the following tasks.

Measuring Bladder Volume

Procedure 1. Prepare for the Exam

Make sure you are familiar with the console's icons and screens. For more information about the system components and user interface, see the chapter “[Introduction](#)” on page 9.

1. If a charged battery is inserted in the console and the touchscreen is blank, then the system is turned off. Press the **On/Off** button .

If the system has a discharged battery or a battery is not inserted, insert a charged battery.

*Note: Before you insert a battery into the console, press the **Test** button and make sure the battery is fully charged. If the charge level in the battery is 20% full or less, replace it with a fully charged battery before proceeding. The system cannot perform an exam while it is connected to external power.*

2. Allow the system to start. When the system has started completely, the Home screen appears as shown in the following figure.

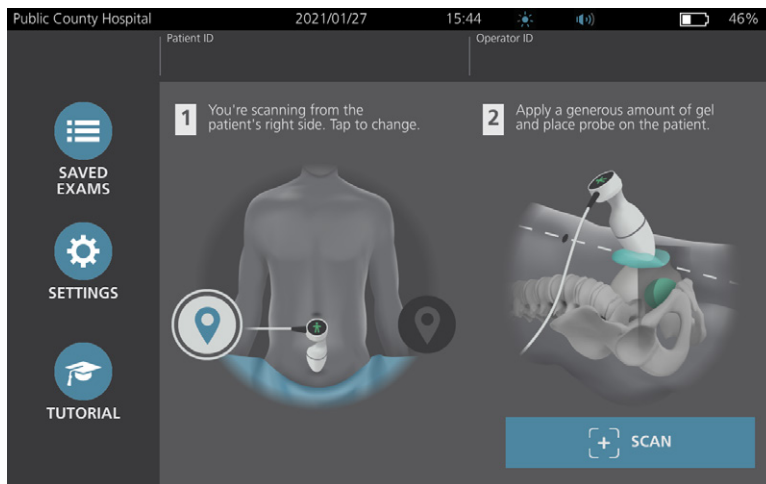

3. Check the battery icon to make sure the battery has sufficient power.
4. Make sure the system has been properly cleaned according to the instructions in the “[Reprocessing](#)” chapter on page 52. In particular, make sure that the touchscreen is not contaminated by gel, cleaner, disinfectant, or any other residue, and that it is completely dry.

Procedure 2. Input Patient Information or Operator ID (Optional)

The system lets you enter the following patient information, which will be saved with the exam and can be printed on the exam report:

- Patient ID
- First name
- Last name
- Sex
- Date of birth

The Operator ID may also be updated at this time. The Patient ID and Operator ID fields are displayed at the top of many screens. You can tap the field and update Patient or Operator ID information whenever the field is visible.

1. On the Home screen, tap **Patient ID**. The Patient and Operator ID screen appears.

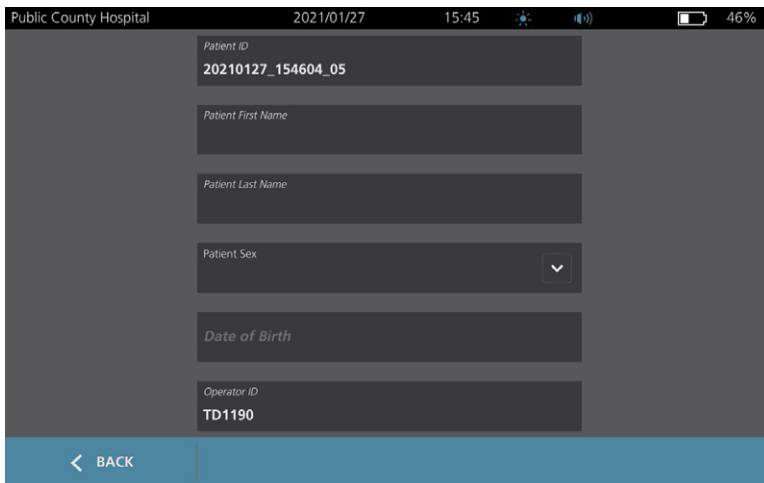

2. On the Patient Data screen, tap **Patient ID**, use the virtual keyboard to type a value, and then tap **Enter**.
3. Tap **Patient First Name**, and then enter the patient's first name.
4. Tap **Patient Last Name**, and then enter the patient's last name.
5. Tap **Patient Sex**, and then tap the sex for the patient.
6. Tap the **Date of Birth** field, vertically swipe to change a value, and then tap the new value to select it. Repeat as needed to set the desired month, day, and year.
7. Tap **Operator ID**, and then use the virtual keyboard to enter or update the operator's identifying information.
8. When you are finished inputting the patient's information, tap **Back**.

Procedure 3. Use a Barcode Scanner to Enter a Patient or Operator ID (Optional)

Using the optional barcode scanner, you can enter IDs for patients or operators by scanning them into the system from barcodes printed on ID badges, patient bracelets and wristbands, charts, and similar documents.

1. On the Home screen, tap either the **Patient ID** box or the **Operator ID** box. The Patient and Operator ID screen appears.

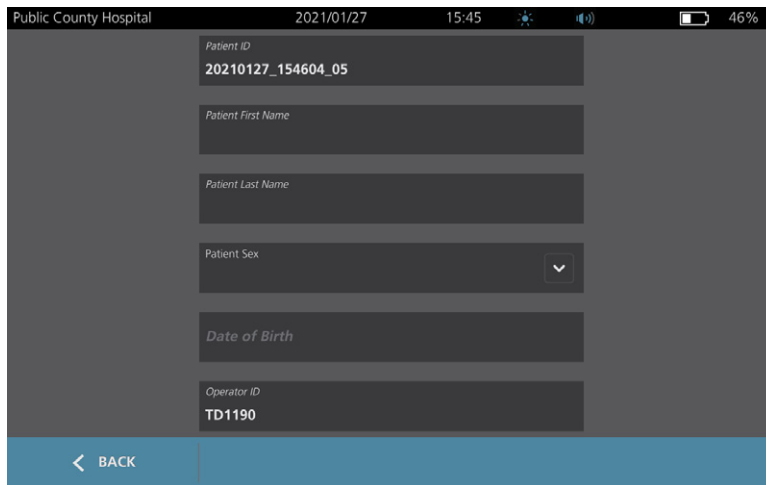

2. At the Patient and Operator ID screen, tap the **Patient ID** box.
3. When the keyboard screen appears, point the barcode scanner at a barcode containing the patient's ID. Press and hold the trigger to activate the scanner.
4. When the system returns to the Patient and Operator ID screen, verify that the patient's ID is showing there.
5. Tap the **Operator ID** box, and then follow Step 3 through Step 4 to enter the operator's ID.
6. Tap **Back** to return to the Home screen.
7. Return the barcode scanner to its holder on the workstation.

Procedure 4. Measure Bladder Volume

The system has several features designed to help with locating and identifying the bladder. These features may be enabled or disabled according to the instructions in “[Configure Exam Settings](#)” on page 33:

- **Live B-Mode Aiming**—The system displays a real-time B-mode ultrasound view of the patient’s abdomen, allowing you to aim the probe and locate the bladder before scanning.
 - **Bladder Outline (BladderTraq)**—In B-mode views, the system highlights the detected edges of the bladder by outlining the bladder area in green.
1. On the Home screen, select whether you are standing on the patient’s left or right side. You do not need to specify the patient’s age or sex to obtain an accurate result.



2. With the patient lying in a supine position and with the abdominal muscles relaxed, palpate the patient’s pubic bone.

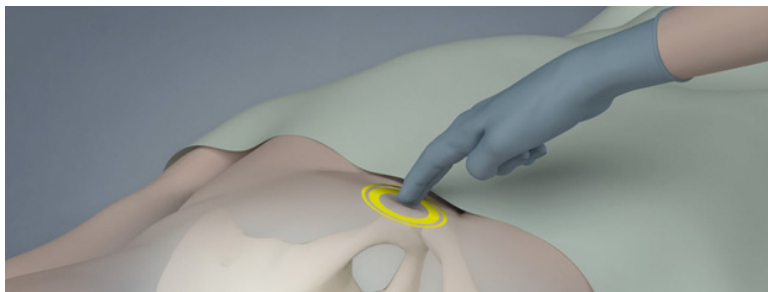

3. Place an ample quantity of ultrasound gel, with as few air bubbles as possible, midline on the patient’s abdomen, approximately 3 cm (1 inch) above the pubic bone.



4. Hold the probe by grasping it with the probe cable running up your wrist and forearm.

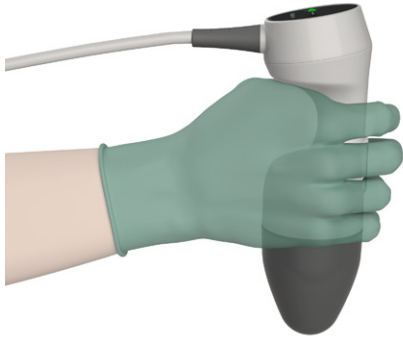

5. Gently press the probe onto the lower abdomen through the gel. The probe cable should be oriented at 90 degrees to the sagittal plane of the patient.

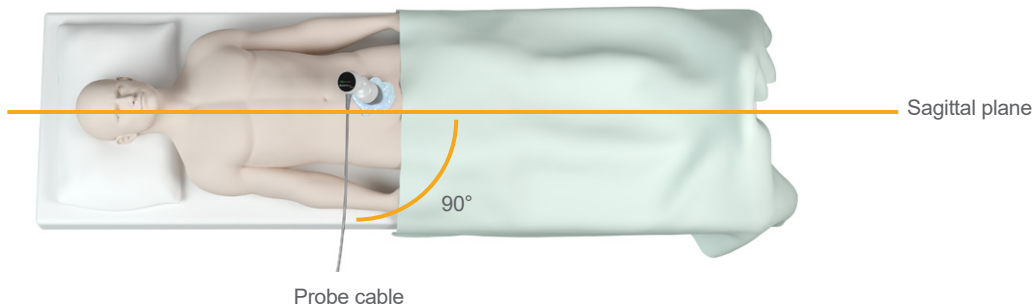

6. Look at the position indicator icons on the top of the probe. Make sure the head of the lighted direction indicator points in the same direction as the head of the patient.

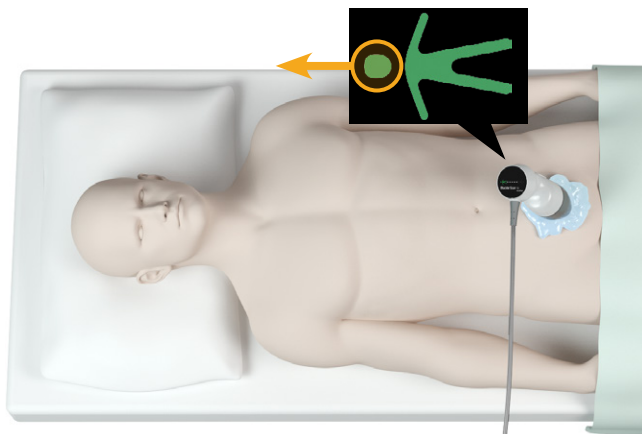

7. If you are scanning an obese patient, lift as much abdominal adipose tissue out of the way of the probe as possible. Apply more pressure to the probe to reduce the amount of adipose tissue through which the ultrasound must pass, but use no more pressure than necessary.
8. Make sure that there are no air gaps between the probe and the patient's skin, and that you are applying enough pressure to maintain adequate skin contact, until the scan is complete. If necessary, add more gel to ensure proper contact.

9. Press the probe button or tap **Scan** on the Home screen.
 - If live B-mode aiming is enabled, continue to Step 10.
 - If live B-mode aiming is disabled, hold the probe steady while the scan is in process, and then continue to the procedure “[Review Exam Results](#)”.
10. If live B-mode aiming is enabled, a real-time B-mode ultrasound image appears on the console screen. Target the bladder by doing the following:
 - Angle the probe slowly from the patient’s left to right until the dark (bladder) area is centered on the vertical green line on the aiming screen.
 - Once the bladder is centered, angle the probe slightly up or down the patient’s midline to obtain the largest possible dark area.

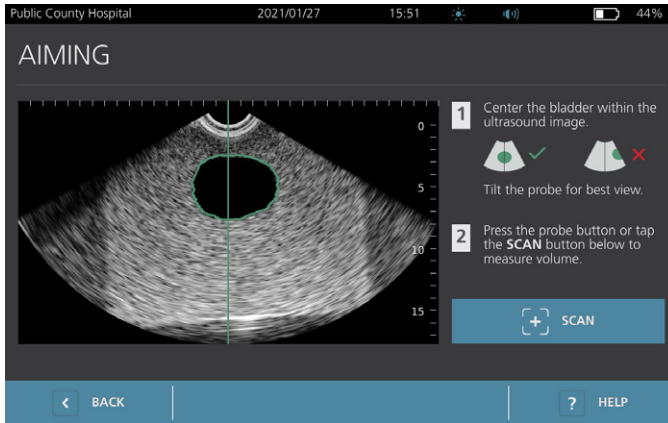

11. Once you are finished aiming the probe, press the probe button or tap **Scan** on the screen. The scanning process begins.
12. Hold the probe steady while the scan is in process. When you hear the end-scan tone, the scan is complete. Continue to the procedure “[Review Exam Results](#)”.

Procedure 5. Review Exam Results

This section describes the procedures that can occur after the scan. Perform the procedures that are applicable for your installation.

CONFIRM OR ADJUST AIM

Aiming technique can have an impact on the bladder measurement result. When the bladder is partially outside the ultrasound field of view or obstructed by the pubic bone at certain scanning angles, then the actual bladder volume may exceed the displayed result. To help ensure the highest degree of accuracy, the system has several features to assist with aiming technique and confirmation.

- When the Results screen appears, check whether a yellow greater than (>) symbol appears next to the recorded volume and the bladder is shown in yellow. If this occurs, a portion of the bladder was outside the ultrasound field of view, and the actual bladder volume may exceed the displayed result. You should aim the probe again and rescan the patient. For guidance on improving the scan results, see Table 9.

Figure 5. Greater Than (>) Symbol Displayed

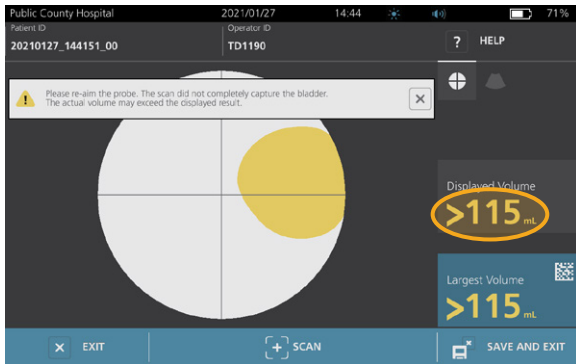

Figure 6. Greater Than (>) Symbol Not Displayed

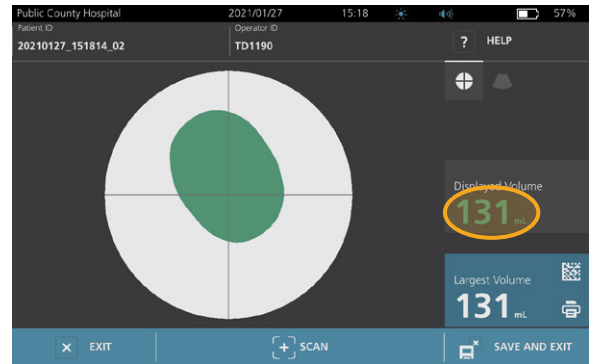



Table 9. Bladder Measurement Accuracy



RESULT	AIMING GUIDANCE	EXAMPLE
Successfully Centered	If the bladder is centered in the field of view, with all edges visible and no gray areas showing, then the scan was successful and the results are as accurate as possible.	
Not Centered	If the bladder is not centered in the field of view, you may move or angle the probe in the direction of the bladder on the display to optimize your results.	
EdgeScan	If one side of the bladder is not within the field of view, then a portion of the bladder was not included in the scan. The system displays a greater than symbol (>) before the measured result, indicating the actual bladder volume may exceed the displayed result. Move or angle the probe in the direction of the bladder on the display to optimize your results.	
Bladder larger than view	If more than one side of the bladder is not within the field of view, then multiple portions of the bladder were not included in the scan. The system displays a greater than symbol (>) before the measured result, indicating the actual bladder volume may exceed the displayed result. You may attempt to capture the entire bladder by rescanning while applying less pressure to the abdomen. However, the bladder may be larger than the field of view, and it may not be possible to capture the entire bladder within the view.	
Pubic bone interference	If a gray area appears, this indicates that the pubic bone is inside the field of view. Although the bladder may be centered and your measurement may be complete, there is a possibility the pubic bone is obscuring part of the bladder. The system displays a greater than symbol (>) before the measured result, indicating the actual bladder volume may exceed the displayed result. You may move or angle the probe to optimize your results.	

- If you want to rescan the patient, on the Results screen, tap **Scan**.
Repeat the scanning procedure as necessary to adjust your aim or confirm the initial measurement.
- When you are finished scanning, you can review the results in B or C modes. (C-mode is displayed by default.) You can save scan results, and you can print scan results if you have the printer installed.

VIEW B-MODE IMAGES

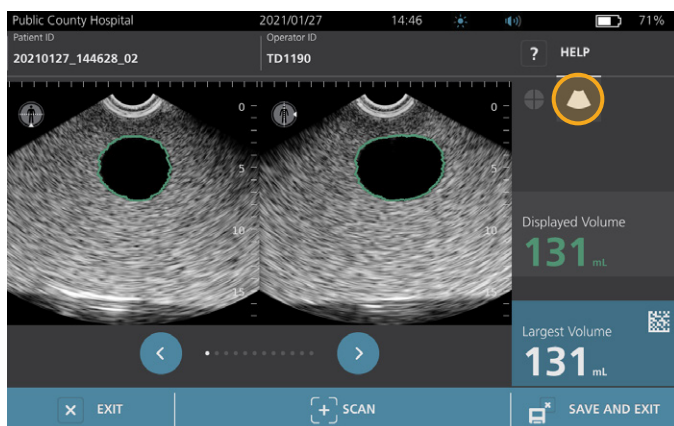
- If B-mode images are activated on your system and you want to view them, tap the **B-mode** icon . Dual-pane B-mode images of the scan appear.



- In the top-left corner of each of the B-mode images, the line through the human figure icon indicates the currently displayed plane. To navigate through the scan planes, tap the **Previous**  and **Next**  icons below the images.

VIEW MULTIPLE SCANS

When you perform more than one scan, the Results screen displays the largest volume obtained. Above the largest volume measurement, the screen indicates the most recent scan volume.

Note: If you scan the patient more than five times during a single exam, the system stores only the five latest scan volumes.

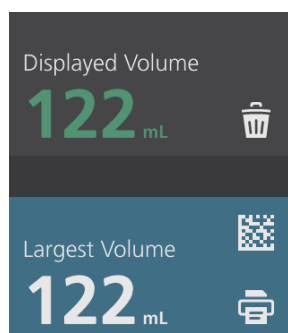

6. If you want to show individual scan measurements, tap the **Scan History** arrow.

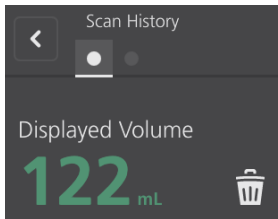

7. Tap the scan measurement number to see the scan display.

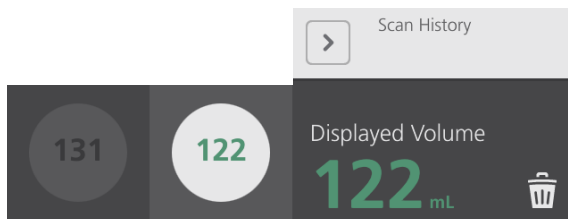

8. To discard the displayed scan, tap the **Delete**  icon.
9. If you want to transfer the scan result to an EHR or EMR system using a barcode reader, continue to the procedure [“Generate a Barcode containing an Exam Result”](#).
Otherwise, skip to the procedure [“Print, Save, or Exit an Active Exam”](#).

Procedure 6. Generate a Barcode containing an Exam Result

Once the system has been configured to generate barcodes, you can display a barcode containing the largest scan result of the current exam on the console's touchscreen. You can then use a barcode reader to collect the scan result and transfer it to your facility's medical records system (which can be either an EHR or an EMR system).

If this feature is active, a barcode icon appears next to the largest scan result stored in the exam, just above the **Print** icon. The exact appearance of the icon matches the type of barcode the system displays, which is selected during configuration.



1. On the Results screen, tap the **Barcode** icon . The barcode, and a string of text showing the exact result statement the barcode contains, appear in a dialog box on the screen.



2. On your medical records system, locate the patient's record and select the field where bladder volume should be stored.
3. Using a barcode reader connected to the medical records system, scan the displayed barcode.
4. Tap the Close  icon in the dialog box to remove the dialog box from the screen.

Procedure 7. Print, Save, or Exit an Active Exam

When the exam is complete, you can take several actions from the Results screen.

If you want to...	Tap...
Record patient information	Patient ID
Print the exam results	Print 
Save the exam results (the system stores the largest measurement)	Save and Exit 
Exit without saving the exam results	Exit 

Note: A printed exam report always contains the largest measurement and the exam date and time, but you can customize the remaining information in the report. For more information about adding and customizing information to be printed, see “Configure Printed and PDF Report Settings” on page 34.

Note: This is the last point in the scanning process where you can add or modify patient or operator information. After you save the exam, patient or operator information cannot be changed.

For information about viewing, deleting, and exporting saved exams, see the section “Managing Saved Exams” on page 49.

Procedure 8. View Cost Savings

The system calculates and displays information related to cost savings, catheterizations avoided, and UTIs avoided. The default settings can be customized to reflect the rates and costs at your facility. For more information on customizing savings preferences, see “Customize Cost Savings Calculations” on page 35.

The system calculates savings since the most recent calculation reset and for the life of the system. You can show, configure, and reset cost savings at any time.

1. On the Home screen, tap **Settings**.
2. Tap **Show Savings**. The Settings screen opens to the Show Savings tab.

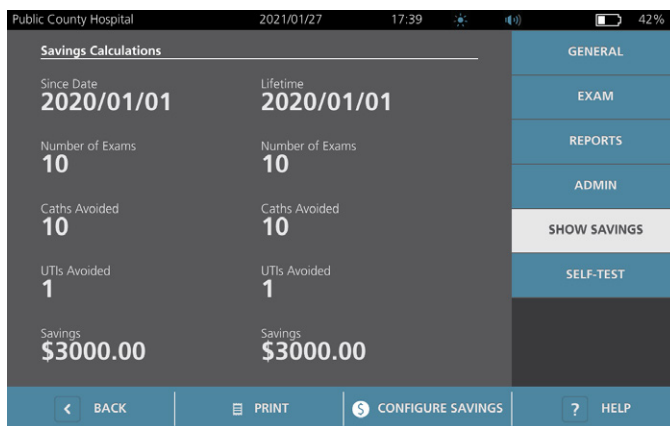

3. If you have a printer and want to print the savings calculations, tap **Print**.
4. When you are finished viewing the savings calculations, tap **Back**. The console returns to the Home screen.

Managing Saved Exams

The system can store saved exams in its internal memory or on external devices such as USB flash drives. If you scan the patient multiple times during an exam, the system saves the largest measurement.

If no external devices are attached, the system stores saved exams in its internal memory. If the system runs out of internal memory, it overwrites the oldest exams as needed to make space for new ones. The system is capable of storing 600 exams within its internal memory.

If a USB drive is attached, the system stores saved exams on the USB drive. If an attached USB drive runs low on space, the system notifies you so that you can switch drives.

You can move exams from the internal memory to an external USB drive. For more information, see the procedure “[Export Saved Exams](#)” on page 51.



Read the “[Warnings & Cautions](#)” section before performing the following tasks.

Procedure 1. Recall a Saved Exam

Once you have saved an exam, it can be recalled using the Saved Exams screen. The Saved Exams screen displays exam results saved on the system’s internal memory if no external drives are attached. If a USB drive is attached, the Saved Exams screen displays exam results saved on the attached drive.

If there are multiple scan results in an exam, the system saves only the largest measurement.

SORT OR SCROLL SCANS

1. On the Home screen, tap **Saved Exams**.
2. If a keypad appears, key in the PIN for Saved Exams, and then tap **Enter**.

The Saved Exams screen opens, displaying a list of exams saved on the default media. Each of the rows on this list corresponds to an exam.

Date/Time	Result	Patient ID	Operator ID	
2021/01/27	15:38	>140 mL	20210127_153828_04	TD2460
2021/01/27	15:36	131 mL	20210127_153634_03	TD2460
2021/01/27	15:03	131 mL	20210127_150406_00	TD1190
2021/01/27	14:46	131 mL	20210127_144628_02	TD1190
2021/01/27	14:41	>115 mL	20210127_144151_00	TD1190

- If you want to sort exams using a different value, tap a sortable field header.
The field headers let you sort the exam list using the following fields. The columns may be sorted in ascending or descending order. The currently selected sorting field is highlighted in white, and an arrow icon indicating the direction of the sort is shown next to the column label.
 - Date/Time
 - Patient ID
 - Operator ID
- If you want to scroll through the exam list, swipe the screen vertically (top to bottom or bottom to top).
- If you want to view an exam, tap anywhere along the exam's row. When an exam is selected for review, the results screen for the exam is displayed.

Procedure 2. Delete a Saved Exam

- On the Home screen, tap **Saved Exams**.
- If a keypad appears, key in the PIN for Saved Exams, and then tap **Enter**.

The Saved Exams screen opens, displaying a list of exams saved on the default media. Each of the rows on this list corresponds to an exam.

Date/Time	Result	Patient ID	Operator ID	
2021/01/27 15:38	>140 mL	20210127_153828_04	TD2460	
2021/01/27 15:36	131 mL	20210127_153634_03	TD2460	
2021/01/27 15:03	131 mL	20210127_150406_00	TD1190	
2021/01/27 14:46	131 mL	20210127_144628_02	TD1190	
2021/01/27 14:41	>115 mL	20210127_144151_00	TD1190	

- If it is not visible in the list, sort or scroll through saved exams to display the one you want. For more information on finding exams, see [“Recall a Saved Exam”](#) on page 49.
- Tap the **Delete** icon at the right end of the exam row.
- On the confirmation dialog box, tap **Yes**.

*Note: You may also delete a saved exam that is currently being viewed. To delete an opened exam, at the bottom of the screen, tap the **Delete** icon.*

Procedure 3. Export Saved Exams

Use this procedure to move exams from the system's internal memory to an external USB drive.

By default, saved exam results are retained in the system's internal memory. When you insert a USB drive into the console, the system immediately begins reading the new drive for saved exam results. If no exams have previously been saved to the external drive, the Saved Exams screen appears blank. However, exam results in the system's internal memory are not lost, and you can export them to the new drive. After exporting the exams, the system removes them from its internal memory.

Exams are saved with unique file names, so that exporting new exams does not overwrite exams already stored on the USB drive.

Exported exam information is stored in PDF format, so that it can be viewed on other devices. Each exam document is stored in a separate folder on the USB drive and includes the following information:

- Patient information
 - C-mode view of the scan (if the C-mode crosshairs image is enabled in reports)
 - B-mode views of the scan (if B-mode images are enabled in reports)
1. Insert a USB drive into an available USB port on the console. If no ports are available, disconnect a USB device such as a barcode scanner.
 2. If the system displays a message advising you to check the USB drive for damage, remove the drive from the port. Repeat Step 1 using a different USB drive.
 3. On the Home screen, tap **Saved Exams**.
 4. If a keypad appears, key in the PIN for Saved Exams, and then tap **Enter**.
 5. On the Saved Exams screen, tap **Export Exams**.

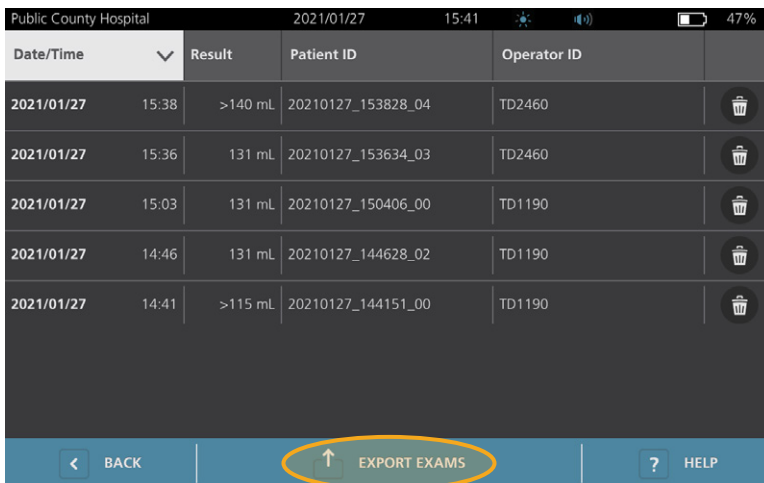

Date/Time	Result	Patient ID	Operator ID	
2021/01/27	15:38	>140 mL	20210127_153828_04	TD2460
2021/01/27	15:36	131 mL	20210127_153634_03	TD2460
2021/01/27	15:03	131 mL	20210127_150406_00	TD1190
2021/01/27	14:46	131 mL	20210127_144628_02	TD1190
2021/01/27	14:41	>115 mL	20210127_144151_00	TD1190

6. On the verification screen that appears, tap **YES** to confirm you want to move exams stored on the console to the USB drive. Do not remove the drive until export is complete.
7. If you disconnected a USB device in Step 1, remove the USB drive and reconnect the device.

Reprocessing



Read the “Warnings & Cautions” section before performing the following tasks.

Cleaning and disinfecting the BladderScan i10 system is an important part of using and maintaining it. Before each use, ensure all system components have been cleaned and disinfected according to the guidance provided in Table 10.

Note: It is understood that all items in the following table will be used as intended.

Table 10. *Reprocessing Requirements for the BladderScan i10 System*

COMPONENT	REQUIRED REPROCESSING LEVELS		
	Clean	Low	High
Console	✓		
Probe Cable	✓		
Probe		✓	
Printer	✓		
Workstation	✓		

The reprocessing levels shown in this table refer to the CDC/Spaulding classifications.

Cleaners & Disinfectants

Disinfection Efficacy

Table 11 lists the low-level disinfectant (LLD) classes that have demonstrated efficacy with the system. For information about the long-term effect of solutions on system materials, see “Compatibility”.

Table 11. *Validated Disinfectants*

ACTIVE INGREDIENT CLASS	TESTED ACTIVE INGREDIENTS
Alcohols (or alcohol with Quat)	55% isopropyl alcohol
Chlorine & chlorine compounds	0.55% sodium hypochlorite (bleach)
Quaternary ammonium (Quat)	0.5% quaternary ammonium compounds
Hydrogen peroxide	1.4% hydrogen peroxide

Compatibility

Table 12 shows the disinfectant and cleaning products that have demonstrated compatibility with system materials. Results with compatible solutions may vary based on exposure periods and system handling. These solutions have not been tested for biological efficacy. Verathon cannot guarantee the compatibility of solutions not included in Table 12. Ensure that you adhere to an inspection schedule as described in “Regular Inspections” on page 56.

Availability of cleaning and disinfection products varies by country, and Verathon is unable to test products in every market. For more information, contact Verathon Customer Care or your local representative. For contact information, visit verathon.com/service-and-support.

Table 12. Compatible Cleaning Solutions and Disinfectants

PRODUCT	ACTIVE CLASS	USE	
		Clean	Disinfect
GAMA Healthcare Clinell Universal Wipes	Quaternary ammonium	■	■
Clorox Healthcare Bleach Germicidal Wipes	Chlorine & chlorine compounds	■	■
Clorox Healthcare Hydrogen Peroxide Wipes	Hydrogen peroxide with alcohol	■	■
Diversey Oxivir TB	Accelerated Hydrogen Peroxide	■	■
Metrex CaviCide	Alcohol with quaternary ammonium	■	■
Metrex CaviCide1	Alcohol with quaternary ammonium	■	■
Metrex CaviWipes	Alcohol with quaternary ammonium	■	■
Metrex CaviWipes1	Alcohol with quaternary ammonium	■	■
Micro-Scientific Micro-Kleen3	Alcohol with quaternary ammonium	■	■
PDI Sani-Cloth Bleach	Chlorine & chlorine compounds	■	■
PDI Sani-Cloth Plus	Alcohol	■	■
PDI Super Sani-Cloth	Alcohol	■	■
Septiwipes	Quaternary ammonium	■	■
Tristel Duo for Ultrasound	Chlorine & chlorine compounds	■	■
Wip’Anios Excel	Alcohol with quaternary ammonium	■	■

Best Practices & Instructions

Cleaning is the removal of all visible soil or contaminants, and *disinfection* is the process of destroying pathogenic organisms or rendering them inert. When cleaning, make sure all foreign matter is removed. This allows the active ingredients of the disinfectant to reach all surfaces.

When cleaning and disinfecting the system or its accessories, follow these best practices:

- Do not let gel or other contaminants dry on the system. This makes removal more difficult.
- Change gloves if they become visibly soiled.
- Always wipe from a clean surface towards a dirty surface.
- As you wipe, overlap your strokes as little as possible.
- If a wipe becomes dry or soiled, replace it with a fresh one.
- Do not reuse dry or soiled wipes.

Procedure 1. Clean & Disinfect the Console, Probe, & Cable

CLEAN THE CONSOLE, PROBE, & CABLE

1. If the system is on, press the **On/Off** button . If prompted, confirm that you want the system to shut down, and then wait for it to do so.
2. Wipe any ultrasound gel completely off of the probe.
3. Using a solution or wipe listed as a cleaner in Table 12, wipe the console, probe, and probe cable according to the instructions provided by the cleaner's manufacturer. (If you are using a solution, apply it with a clean towel.) Repeat as needed to make sure that all visible contamination is removed.
4. If the console remains wet, you may use a clean soft cloth or paper towel to remove any residual cleaning solution. Allow the touchscreen to dry completely before use.



DISINFECT THE PROBE

5. Using a germicidal wipe with an active ingredient class from Table 11, wipe the probe dome according to the instructions provided by the wipe's manufacturer.

Wipe again as many times as necessary to keep the component visibly wet for the entire exposure period. You may use as many wipes as you need.

6. Allow the probe to air dry completely. Cleaning and disinfection is complete, and the system is ready for use.



Procedure 2. Clean the Printer (Optional)

1. If the system is on, press the **On/Off** button . If prompted, confirm that you want the system to shut down, and then wait for it to do so.
2. Using a wet cloth or a wipe indicated for cleaning medical devices, wipe the printer according to the instructions provided by the wipe's manufacturer. Repeat as needed to make sure that all visible contamination is removed.
3. If the printer remains wet, you may use a clean soft cloth or paper towel to remove any residual cleaning solution.



Maintenance & Safety

Regular Inspections

Verathon offers certification services through authorized BladderScan service representatives or a Verathon service center. Certification service includes comprehensive inspection and testing of the system. For more information, contact your authorized Verathon Service Center, your local BladderScan distributor, or Verathon Customer Care.

WEEKLY INSPECTIONS

Once a week, you should inspect the following system components for damage or cracks:

- Console
- Probe
- Probe cable
- Printer
- Printer cable
- Workstation
- Power adapter
- Power cable
- Power cord
- Battery or batteries
- Plugs

Cracks that allow the ingress of fluid into the console or probe may affect the performance of the system. Other than the maintenance included in this manual, all service and repairs must be completed by an authorized BladderScan service representative or Verathon Service Center. For more information, contact Verathon Customer Care or your local representative.

System Security Information

To maintain patient safety and privacy, Verathon recommends these practices:

- Allow only authorized operators to have physical access to the system.
- Set the Auto-Shutdown and Inactivity Timeout intervals to their shortest practical lengths.
- Keep the PIN for Settings and the PIN for Saved Exams set.
- Do not use the same string of digits for both the PIN for Settings and the PIN for Saved Exams.
- Do not use a PIN that is easy to guess. For example, do not set either PIN to a sequence of digits, such as 2345, or strings of a single digit, such as 1111.
- Give the PIN for Saved Exams only to people who need access to exam information.
- Give the PIN for Settings only to people who are authorized to set the PIN for Saved Exams and to configure BladderScan systems.
- After you have copied saved exams from a USB drive to a permanent storage location, delete the exams from the USB drive.
- Before you begin an exam, check to make sure that all USB drives have been disconnected from the system.
- Deactivate the USB ports if they will not be used.
- When you are finished configuring the system or reviewing saved exams, return to the Home screen.

Calibration

The system does not require routine or periodic calibration under normal use.

If your facility or regional regulations require periodic maintenance, refer to the procedure [“Complete a CaliScan Test”](#) on page 62, which can be used to confirm proper probe functionality.

System Software

Verathon may release software upgrades for the system. Software upgrades are supplied directly by Verathon or an authorized representative. For information about how to upgrade the device software, see [“Update the Software”](#) on page 61.

Do not perform any software upgrades from third-party vendors or attempt to modify the existing software. Doing so may damage the system and void the warranty.

Device Disposal

The system and accessories may contain mineral oils, batteries, and other environmentally hazardous materials. When the system has reached the end of its useful service life, return it and any related accessories to a Verathon Service Center for proper disposal. Alternatively, follow your local protocols for hazardous waste disposal.

Warranty

Information about the manufacturer’s warranty is included with the product. Extended warranties may be available for your system. For more information, contact Verathon Customer Care or your local representative.

Maintenance Procedures

Procedure 1. Load Thermal Paper into the Printer (Optional)



Read the “[Warnings & Cautions](#)” section before performing the following task.

1. Slide the printer door upward to unlock it, and then rotate the door down to open. Placing your thumb on the outside of the printer and squeezing can make it easier to open the door.
2. If this is the first time you are loading the printer, there may be a sheet of paper in the printer mechanism. Remove the paper sheet.
3. Place a roll of thermal paper inside the door as shown so that the loose end of the paper exits over the top of the roll.



4. Hold the paper end so that it protrudes from the top of the printer, and then close the printer door. Make sure the door clicks into place.



5. Tear off any excess paper protruding from the printer. For best results, pull the paper diagonally, starting the cut on one side of the paper and finishing on the other.

Procedure 2. Run a Self-Test

The BladderScan i10 self-test function completes self-diagnostic testing on the following:

- Internal memory (and external devices, if any)
 - Hardware components, including the console, installed battery, probe, and printer, if attached
 - BladderScan i10 software
1. On the Home screen, tap the **Settings** icon, and then tap **Self-Test**. The Settings screen opens to the Self-Test tab, where the system completes the self-test and displays the results.

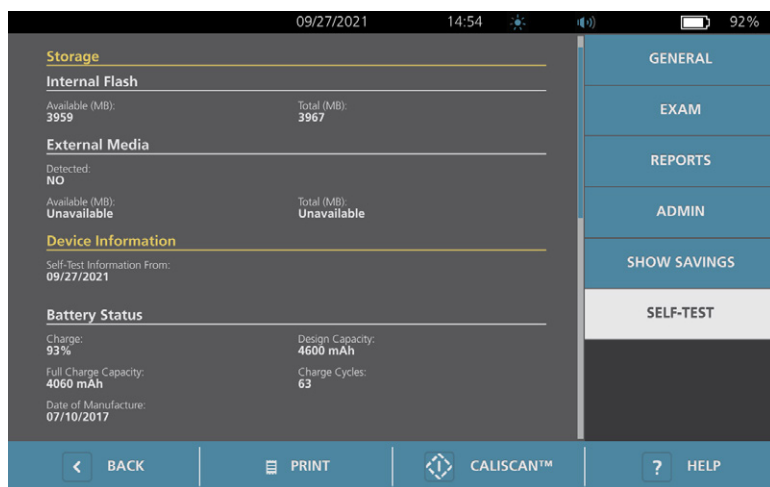

2. Scroll through the on-screen test results by vertically swiping with your finger on the touchscreen.
3. If the screen indicates any failed tests or abnormal results, contact Verathon Customer Care or your local representative.
4. If you want to print the self-test results, tap **Print**.
5. When you are finished viewing the test results, tap **Back**. The console returns to the Home screen.

Procedure 3. Update the Software

From time to time, Verathon may make software updates available for your system. To inquire about the availability of a software update, contact Customer Care or your local representative.

Note: If the system's USB ports are normally deactivated for security purposes, you will need to activate them before performing this procedure and deactivate them again after the procedure is complete. For information about activating and deactivating the USB ports, see "Turn the USB Ports On or Off" on page 67.

1. Export any exams you need to retain. For more information, see "Export Saved Exams" on page 51.
Note: Make sure the export is complete before you continue.
2. Make sure the probe is attached to the console.
3. If there are any USB drives connected to the console, remove them.
4. Make sure that the battery is at least 20% charged.
5. If the system is connected to external power, disconnect it.
6. *After the Home screen appears and the Scan icon is available*, insert a USB drive containing a valid software update package into one of the two larger USB ports on the console. If no ports are available, disconnect a USB device such as a barcode scanner.

If the system displays a message advising you to check the USB drive for damage, remove the drive from the port. Repeat Step 6 using a different USB drive.



7. If a keypad appears, key in the PIN for Settings, and then tap **Enter**.
8. When the system asks whether you want to update the software, tap **Update Now**.
The system begins updating and may restart during the update process. Do not remove the battery or the USB drive while the update is under way.
9. When you are prompted to restart the system, press the **On/Off** button (⏻) and hold it for about half a second. When you are asked if you want to turn the system off, tap **Yes**.
10. Press the **On/Off** button (⏻) to turn the system back on.
11. When the system advises you that the software has already been updated, tap **OK**. If the Home screen appears, skip to Step 13.
12. If the system prompts you to repeat steps 8 through 11, do so.
13. Disconnect the USB drive from the console. If you disconnected a USB device in Step 6, reconnect it.

Procedure 4. Complete a CaliScan Test

The BladderScan i10 system includes the *CaliScan* test, which tests the probe's mechanical components and transducer function. This test can be used for preventative maintenance or as a diagnostic tool if a probe has been dropped or in storage for an extended amount of time.

Note: The CaliScan test evaluates only the mechanical condition of the probe. The BladderScan i10 system does not require calibration as normal scheduled maintenance.

1. Make sure that the BladderScan i10 system is disconnected from external power.
2. On the Home screen, tap **Settings**, and then tap **Self-Test**.
3. Tap **CaliScan™**.



4. Review the test instructions, and then tap **Test**. The system begins to test probe components. A message and process indicator appear while the test is in process.

Note: Once the test has started, do not press the On/Off button, disconnect the probe from the console, or connect external power to the console.





5. Proceed according to the message that appears on the screen.

<i>If the message reports that ...</i>	<i>Then ...</i>
The probe passed the test	When you are finished reviewing the results, tap Back .
The probe failed the test	Restart the system and try the test again. If the test continues to fail, contact Verathon Customer Care or your local representative.

Procedure 5. Turn the System Off

1. If you are performing an exam, save the exam information.

Note: If you omit this step and attempt to turn off the system during an exam, the system prompts you to confirm that you want to continue without saving the exam results.

2. Press the **On/Off** button  and hold it for about half a second.
3. When a dialog box appears on the screen and asks if you want to turn off the system, release the **On/Off** button .
4. Tap **Yes** to confirm that you want to turn off the system.



Procedure 6. Perform an Unconditional Shutdown

If it becomes necessary for emergency or troubleshooting reasons, you can shut down the system unconditionally. The system stops all running processes and shuts down immediately. The next time you press the **On/Off** button , there will be a wait of several seconds before the Home screen appears.



IMPORTANT

If the system is displaying the results of an unsaved exam, save the exam before you continue. You can turn off the system completely while you are evaluating an unsaved exam, but if you do so, the exam information is lost.

1. Place a finger or thumb on the **On/Off** button  and hold it in place for at least 1.5 seconds. A shutdown indicator appears at the lower left corner of the screen. A progress bar within the indicator becomes progressively shorter while the system waits to begin its shutdown routine.

*Note: When you first press the **On/Off** button , the option to turn the system off normally is still available, and the system displays the dialog box asking if you want to turn it off that way. While the shutdown indicator is on the screen, removing your finger from the **On/Off** button  cancels the shutdown.*



2. Continue holding your finger or thumb in place on the **On/Off** button  until the console's touchscreen is black and the LED next to the **On/Off** button  is no longer illuminated.

IMPORTANT

If the system becomes completely unresponsive, you can still shut it down by placing a finger or thumb on the **On/Off** button  and holding it in place for 6 seconds or longer. If you shut the system down this way, however, some stored information may be lost.

Procedure 7. Copy the System's Configuration to Other Systems

After you have set up a BladderScan i10 system with the configuration you want to use throughout your facility, you can copy the configuration from the first system to all of the others.

Note: The following two procedures copy all settings except for the asset tag on the original system, if the destination system has the same software version installed. Otherwise, if the destination system is running an older software version with a different configuration structure, the procedures copy the settings that are compatible with that software version, except for the asset tag.

EXPORT A SYSTEM'S CONFIGURATION TO A USB FLASH DRIVE

1. Insert a blank USB drive into an open USB port on the console. If no ports are available, disconnect a USB device such as a barcode scanner.

If the system displays a message advising you to check the USB drive for damage, remove the drive from the port. Repeat Step 1 using a different USB drive.
2. At the Home screen, tap **Settings**.
3. At the Settings screen, tap the **Admin** tab.
4. If a keypad appears, key in the PIN for Settings, and then tap **Enter**.
5. On the Admin tab, tap **Export Settings to USB**.
6. When you are asked if you want to export the settings, tap **Yes**.
7. When the progress indicator disappears, disconnect the USB drive from the console.
8. If you disconnected a USB device in Step 1, reconnect the device.
9. Tap the **Back** button twice. This returns you to the Home screen.

IMPORT A CONFIGURATION TO ANOTHER SYSTEM

When the system detects that a USB drive has been connected, it scans the drive for a configuration file. If it finds one, it automatically proceeds to import the configuration. As a result, you can apply an exported configuration to a different system by simply connecting the USB drive that contains the configuration.

Do not begin importing a configuration if any of the following are true:

- The system is performing a scan, or an exam has not been saved.
 - The system is busy.
 - Another USB drive is already connected.
 - The system's battery is less than 20% charged.
1. Insert a blank USB drive into an open USB port in the console. If no ports are available, disconnect a USB device such as a barcode scanner.
 2. If necessary, turn on the system.

3. Watch to see whether one of the following messages appears:
- The settings configuration in the USB drive is identical to the one in the system and does not need to be modified.
 - The settings configuration in the USB drive is not compatible with the system.

<i>If ...</i>	<i>Then ...</i>
One of these messages appears	Tap OK , and then remove the USB drive from the console.
Neither of these messages appears	Continue to Step 4.

4. If you are advised that the settings configuration in the USB drive is from a different software version than the one in the system, select whether or not to continue importing the settings by tapping **Yes** or **No**.

<i>If you tap ...</i>	<i>Then ...</i>
Yes	Wait for the system to finish importing the compatible settings.
No	Remove the USB drive from the console. If you disconnected a USB device in Step 1, reconnect the device.

5. Remove the USB drive immediately after it has imported the new settings and restarted. If you disconnected a USB device in Step 1, reconnect the device.

Procedure 8. Turn the USB Ports On or Off

IMPORTANT

If a printer is connected, it cannot operate unless the USB ports are active.

If necessary, you can deactivate or reactivate the USB ports by following this procedure.

1. At the Home screen, tap **Settings**.
2. At the Settings screen, tap the **Admin** tab.
3. If a keypad appears, key in the PIN for Settings, and then tap **Enter**.

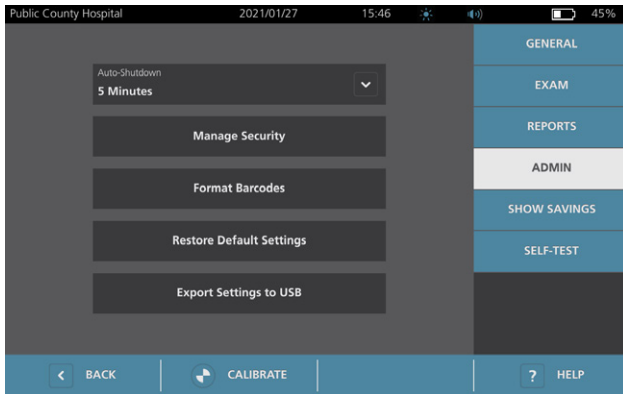

4. On the Admin tab, tap **Manage Security**.
5. In the Manage Security dialog box, tap the **Enable USB Ports** check box to select or clear it.
6. Tap the **Back** button twice. This returns you to the Home screen.

Help & Troubleshooting

Help Resources

Procedure 1. Watch the Onboard Tutorial

The BladderScan i10 system includes an onboard tutorial with instructions on how to scan and manage exams. It is recommended that you watch the tutorial before using the system. The tutorial does not include an audio track.

*Note: The setting and configuration screens include access to screen-specific help text. To see help text on any setting or configuration screen, tap **Help**.*

1. Tap the appropriate button on the screen that is currently displayed. The Tutorial Control screen opens and the tutorial begins to play.

<i>On...</i>	<i>Tap...</i>	<i>The tutorial starts at...</i>
The Home screen	Tutorial	The beginning
The Results screen	Help	The section on viewing and saving results
The Saved Exams screen	Help	The section on reviewing saved exams

While the tutorial is playing, you can take these actions:

- View the previous frame of the tutorial (tap **Previous**)
 - View the next frame of the tutorial (tap **Next**)
 - Pause the tutorial (tap **Pause**) or continue the tutorial when paused (tap **Play**)
2. When you are finished viewing the tutorial, tap **Exit**.

Procedure 2. Watch the Onboard Training Video

The BladderScan i10 system includes a training video in some languages. This video demonstrates how to begin using the system and how to perform a typical exam.

*Note: If the onboard training video is not available in the selected language, the **Video** icon does not appear on the Home screen.*

1. If necessary, return to the Home screen.
2. Tap **Video**.

While the video is playing, you can take these actions:

- Move forward 5 seconds (tap **Skip Ahead**)
 - Move backward 5 seconds (tap **Skip Back**)
 - Adjust the playback position (tap the display and then drag the button on the position bar)
 - Pause the video (tap **Pause**) or continue the video when paused (tap **Play**)
3. When you are finished viewing the training video, tap **Exit**.

Customer Services Resources

Verathon provides several customer service resources, as described in Table 13.

Table 13. Customer Service Resources for BladderScan i10 Systems

RESOURCE	DESCRIPTION
In-service USB	USB drive included with your system that includes instructions on using it.
Onboard training video	A short video clip on how to use the system is available in some languages by tapping Video from the Home screen.
Onboard help tutorial	A training module installed on your BladderScan is available by pressing Help from the Home, Aiming, and Results screens.
Onboard help text	Screen-specific online help text is available by pressing Help from the setting and configuration screens.
Phone support	Refer to the list of Verathon Customer Care resources available at verathon.com/service-and-support

Device Repair

The system components are not user-serviceable. Verathon does not make available any circuit diagrams, component parts lists, descriptions, or other information that would be required for repairing the device and related accessories. All service must be performed by a qualified technician. If you have any questions, contact Verathon Customer Care or your local representative.



Read the “[Warnings & Cautions](#)” section.

Troubleshooting Procedures

Procedure 1. Troubleshoot Console Battery Issues

1. If the system does not turn on, the battery may be dead or simply discharged. To determine the battery's condition, attempt to recharge it according to the instructions in the procedure "[Charge the Battery](#)" on page 26.
2. If you cannot recharge the battery but a second battery is available, remove the first battery and insert the second battery. If necessary, charge the second battery according to the instructions in the procedure "[Charge the Battery](#)" on page 26, and then verify that the system operates normally.
3. If the system does not respond to these troubleshooting steps, contact Verathon Customer Care.

Procedure 2. Troubleshoot Probe Connection Issues

If the probe is not functioning, or if the console displays an error message indicating that the probe is not attached, use this procedure to troubleshoot the issue.

1. Check to see if external power is connected. If it is, disconnect it. If this does not resolve the problem, continue to Step 2.
2. If necessary, press the **On/Off** button (⏻). When prompted, confirm that you want the system to turn off, and then wait for it to do so.
3. Press the **On/Off** button (⏻) again to activate the system.
4. If the message appears again and you have an extra battery, repeat Step 2. Replace the battery according to the instructions in the procedure “[Insert a Battery](#)” on page 24, and then repeat Step 3.
5. If the message still appears, contact Verathon Customer Care.

Procedure 3. Troubleshoot Probe Aiming Issues

Use this procedure to troubleshoot the following problems:

- The initial aiming scan is not successful.
 - The aiming image is off center, but moving the probe in the expected direction of the bladder moves the image further off center.
1. On the Home screen, verify that the selected position reflects your position in relation to the patient.

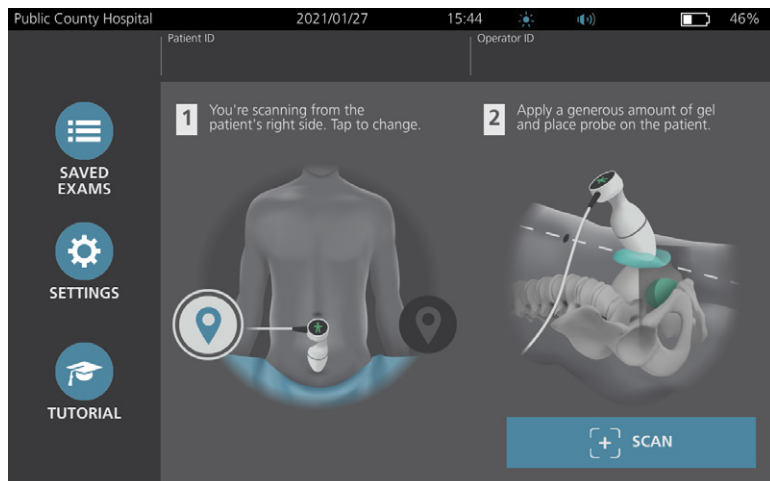

2. Hold the probe by grasping it with the probe cable running up your wrist and forearm.

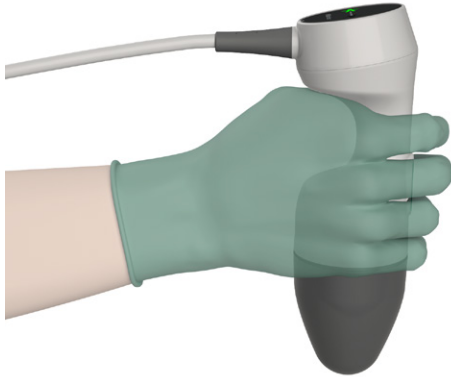

3. With the probe midline on the patient, make sure the probe cable is oriented at 90 degrees to the sagittal plane.

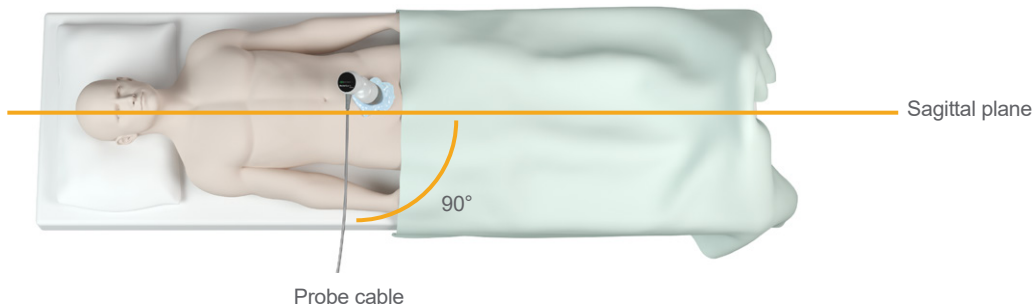

4. Look at the position indicator icons on the top of the probe. Make sure the head of the lighted direction indicator points in the same direction as the head of the patient.

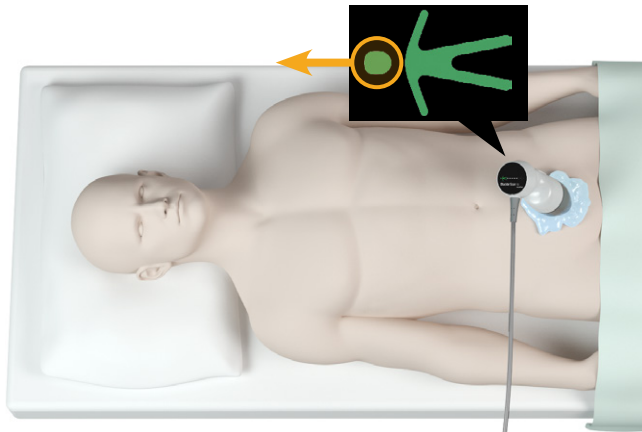

5. After verifying the selected orientation, probe placement, and probe display, rescan the patient. Hold the probe steady while the scan is in process. For detailed scanning instructions, see [“Measure Bladder Volume”](#) on page 41.

Procedure 4. Restore Factory Defaults

Use this procedure to restore the original settings for the system. Running this procedure removes all user information—including customized system settings, cost savings calculations, and saved exams—from the system. Do not restore factory defaults if you want to retain this information.

1. On the Home screen, tap **Settings**, and then tap **Admin**.
2. If a keypad appears, key in the PIN for Settings, and then tap **Enter**.
3. Tap **Restore Default Settings**.
4. If you want to restore the system defaults, tap **Yes**. The system restores factory settings and then restarts.

Procedure 5. Troubleshoot Irregular Printouts (Optional)



Read the “Warnings & Cautions” section before performing the following task.

If the printer is producing irregular printouts, you may need to clean the print head.

1. If necessary, press the **On/Off** button . When prompted, confirm that you want the system to turn off, and then wait for it to do so.
2. Slide the printer door upward to unlock it, and then rotate the door down to open. Placing your thumb on the outside of the printer and squeezing can make it easier to open the door.
3. If a thermal paper roll is in the printer, remove it.

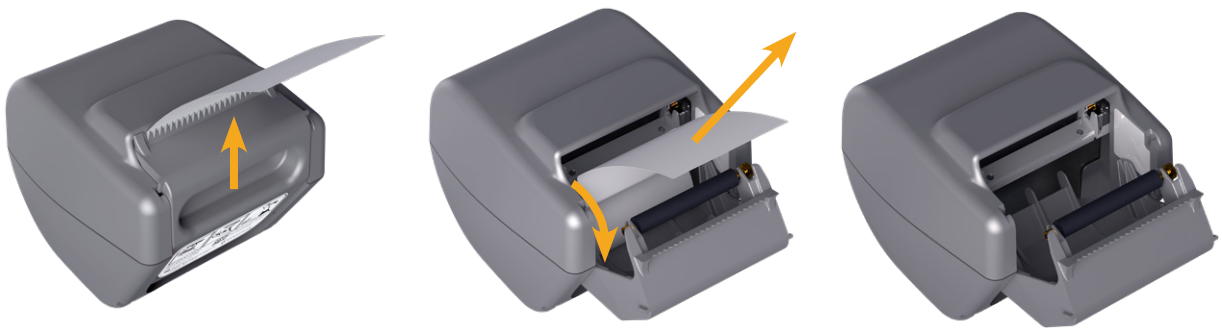

4. Using a cotton swab dipped in isopropyl alcohol (IPA), wipe along the length of the print head. Do not use your fingers or any hard or abrasive surfaces to clean the print head.

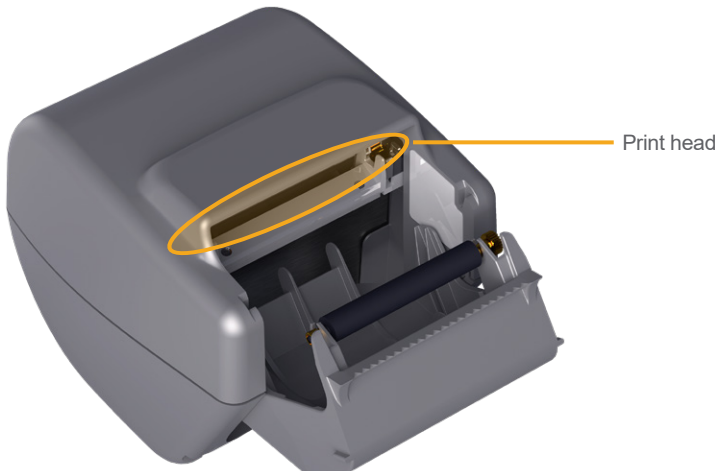

5. Allow the print head to dry completely.
6. Make sure there is no lint or visible debris on the print head.

7. Verify the position of the printer driver roller in the printer door:
 - The printer drive roller's plastic bushings should rest inside the light gray plastic clips in the printer door as shown. The gear should be outside the clip.
 - If the printer drive roller has fallen out of the gray clips, replace it according to the instructions in the procedure [“Replace the Printer Drive Roller \(Optional\)”](#) on page 77.



8. Load the thermal paper and close the printer door according to the instructions in the procedure [“Load Thermal Paper into the Printer \(Optional\)”](#) on page 59.
9. If the printer continues to produce irregular printouts, contact Verathon Customer Care.

Procedure 6. Clear a Paper Jam (Optional)

If the printer is jammed, follow this procedure to remove the paper jam.

1. If necessary, press the **On/Off** button (⏻). When prompted, confirm that you want the system to turn off, and then wait for it to do so.
2. Slide the printer door upward to unlock it, and then rotate the door down to open. Placing your thumb on the outside of the printer and squeezing can make it easier to open the door.

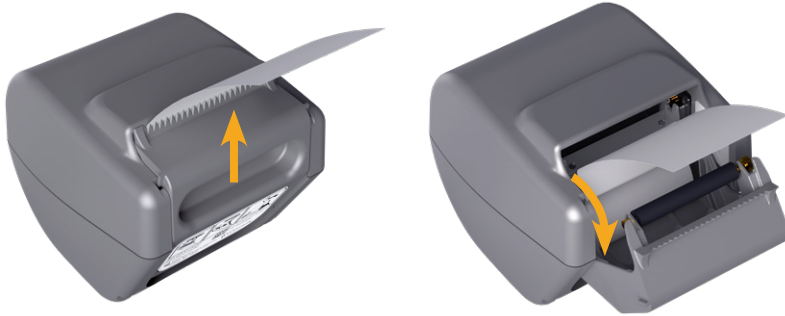

3. Pull the paper gently to clear the paper jam. If necessary, pull any ripped or folded paper out of the printer and remove any bits of paper that have become separated from the roll.
4. Verify the position of the printer drive roller in the printer door:
 - The printer drive roller's plastic bushings should rest inside the light gray plastic clips in the printer door as shown. The gear should be outside the clip.
 - If the printer drive roller has fallen out of the gray clips, replace it according to the instructions in the procedure "[Replace the Printer Drive Roller \(Optional\)](#)" on page 77.



5. Load the thermal paper and close the printer door according to the instructions in the procedure "[Load Thermal Paper into the Printer \(Optional\)](#)" on page 59.
6. If the paper on the outside of the printer is ripped or torn, tear it off, pulling to one side to aid in cutting.
7. If you cannot clear the paper jam or the printer continues to jam, contact Verathon Customer Care.

Procedure 7. Replace the Printer Drive Roller (Optional)

The printer drive roller can fall out if the printer is dropped. If the roller has fallen out, printing may be irregular or not occur at all. You may be unable to close the printer door.

1. If necessary, press the **On/Off** button (⏻). When prompted, confirm that you want the system to turn off, and then wait for it to do so.
2. Slide the printer door upward to unlock it, rotate the door down to open, and then remove the paper roll.

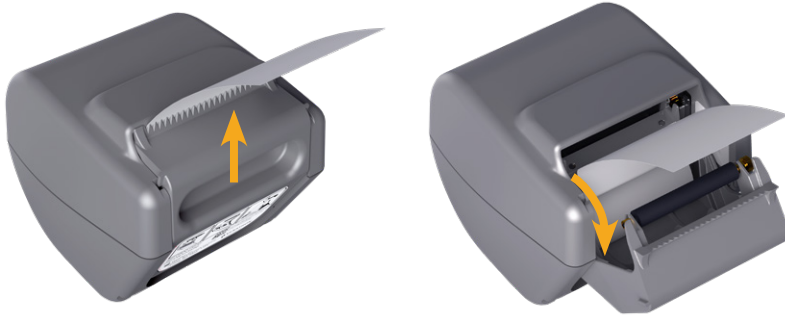

3. Look for the printer drive roller inside the light gray plastic clips in the printer door.
4. If the printer drive roller has fallen out, put it back into place as shown. The gear should be on the right when viewed from the front of the printer, and the plastic bushings should be centered between the light gray clips in the printer door.



5. Push down on the printer drive roller to seat it. Make sure that it snaps into the light gray clips in the printer door and is held in place on both sides.



6. Load the thermal paper and close the printer door according to the instructions in the procedure [“Load Thermal Paper into the Printer \(Optional\)”](#) on page 59.
7. If the printer continues to malfunction, contact Verathon Customer Care.

Procedure 8. Evaluate Console Error Messages

Table 14 lists the initial actions you should take if one of the error messages in the table appears on the system's main display. If you are not able to correct the error, contact Verathon Customer Care for additional instructions.

Table 14. Common Console Error Messages

MESSAGE TEXT	TROUBLESHOOTING STEPS
The console is too hot. Turn off the system and allow the battery to cool.	Turn off the system, disconnect external power, and wait for the battery to return to a normal temperature.
The console is too hot and may turn off if the temperature increases.	Turn off the system and wait until the battery returns to a normal temperature.
Overcharged battery. Turn off the system and contact Verathon.	Turn off the system and contact Verathon Customer Care.
Incompatible software versions. Contact Verathon.	Make sure you are using the system with its original probe.
	If the probe has been sent in for service and returned with a software update USB drive, install the software update.
Please unplug the system from the power outlet to begin scanning.	Disconnect external power from the system before you start scanning. The probe does not function while external power is connected.
Please unplug the system from the power outlet to resume scanning.	Disconnect external power from the system until you have saved and completed the exam. The probe does not function while external power is connected.
No probe detected. Please connect a probe to begin scanning.	Check the connection between the probe and the console to make sure it is secure.
No probe detected. Please connect a probe to resume scanning.	
Loss of ultrasound data.	Contact Verathon Customer Care.
Data stream error. The scan is missing some ultrasound data.	
Transducer error. The probe may not capture ultrasound data.	

Probe motor error. The scan may not completely measure the bladder.	Attempt to scan again and confirm that the error continues to appear.
	Contact Verathon Customer Care.
The scan did not identify a bladder.	Make sure the probe is securely in contact with the patient, that you are using enough gel, and that the probe is positioned correctly.
External storage device removed. Internal storage will be used.	Check the connection between the USB flash drive and the console. Alternatively, use a different USB flash drive.
Insufficient storage space. Please delete exams or insert storage device.	Transfer older files from the USB flash drive to a computer, and then delete those files from the USB flash drive, before you connect the drive to the console. Alternatively, use a different USB flash drive.

Product Specifications

System Specifications

Overall System Specifications

Table 15. General System Specifications

ITEM	SPECIFICATION	
General Specifications		
Classification	Internally powered, Type BF	
Expected product life	7 years	
Ingress protection (IP) against water	Console	IPX2
	Probe	IPX4
	Printer	IPX0
	Power adapter	IP22
	Battery	IPX0
Operating Conditions		
Use	Indoor	
Temperature	+10 to +40°C (50 to 104°F)	
Relative humidity	20 to 75%	
Ambient air pressure	+700 hPa to 1060 hPa	
Storage Conditions		
Use	Indoor	
Temperature	-10 to +60°C (14 to 140°F)	
Relative humidity	15 to 85%	
Ambient air pressure	+600 hPa to 1060 hPa	

Table 16. Ultrasound Acoustic Output Parameters (IEC Standard)

INDEX LABEL		MI	TIS		TIB		TIC
			AT SURFACE	BELOW SURFACE	AT SURFACE	BELOW SURFACE	
Maximum index value [*]		0.433	2.21×10 ⁻³		—	—	—
Index component value			2.21×10 ⁻³	2.21×10 ⁻³	—	—	
Acoustic Parameters	$p_{r,\alpha}$ at z_{MI}	(MPa)	0.652				
	P	(mW)		0.854	—	—	—
	$P_{1 \times 1}$	(mW)		0.205	—	—	
	z_s	(cm)				3.3	
	z_b	(cm)				—	
	z_{MI}	(cm)	3.3				
	$Z_{pii,\alpha}$	(cm)	3.3				
	f_{awf}	(MHz)	2.27	2.27		—	—
Other Information	pr_r	(Hz)	408				
	sr_r	(Hz)	5.1				
	n_{pps}		1				
	$I_{pa,\alpha}$ at $z_{pii,\alpha}$	(W/cm ²)	11.3				
	$I_{spta,\alpha}$ at $z_{pii,\alpha}$ or $z_{sii,\alpha}$	(mW/cm ²)	0.165				
	I_{spta} at z_{pii} or z_{sii}	(mW/cm ²)	0.277				
	p_r at Z_{pii}	(MPa)	0.844				
Operating Control Conditions	2.6 MHz pulse	●	●	●			

* MI and TI values are both below 1.0.

Table 17. Ultrasound Acoustic Output Parameters (FDA Format)

The data in each column corresponds to the highest measured global maximum value for each of the parameters in the column title (MI, $I_{SPTA.3}$, $I_{SPPA.3}$), measured for three probes.

ACOUSTIC OUTPUT			MI	$I_{SPTA.3}$ (mW/cm ²)	$I_{SPPA.3}$ (W/cm ²)
Global Maximum Value*			0.455	0.181	12.2
Associated Acoustic Parameter	$p_{r,3}$	(MPa)	0.682		
	P_0	(mW)		0.863	0.863
	f_c	(MHz)	2.29	2.29	2.29
	Z_{sp}	(cm)	3.40		3.40
	Beam dimensions	x_{-6} (cm)			0.401
		y_{-6} (cm)			0.401
	PD	(µsec)	0.753		0.753
	PRF	(Hz)	408		408
	EDS	Az. (cm)			5.25
Ele. (cm)				1.28	

* MI and TI values are both below 1.0.

Accuracy Specifications

Table 18. Accuracy Specifications

SPECIFICATION	DESCRIPTION	
Bladder volume range	0 to 999 mL	
Volume accuracy	greater than 100 mL	± 7.5%
	0–100 mL	± 7.5 mL

The following examples show how the accuracy ranges shown in Table 18 may affect reported volume measurements.

- If the measurement is greater than 100 mL, the accuracy range is ± 7.5% and is calculated as follows:
 $240 \text{ mL} \times 7.5\% = 18 \text{ mL}$
 $240 \pm 18 \text{ mL} = \mathbf{222\text{--}258 \text{ mL}}$
- If the measurement is 0–100 mL, the accuracy range is ± 7.5 mL and is calculated as follows:
 $80 \text{ mL} \pm 7.5 \text{ mL} = \mathbf{73\text{--}88 \text{ mL}}$ (rounded to the nearest whole number)

The accuracy specifications assume the system is being used according to the instructions provided by Verathon while scanning a tissue-equivalent phantom.

While the upper threshold of the accuracy range is 999 mL, the system is capable of detecting and displaying bladder volumes above 999 mL. Verathon cannot guarantee the accuracy of measurements outside of the stated specifications.

Component Specifications

Table 19. *BladderScan i10 Console (0570-0412)*

ITEM	SPECIFICATION
General Specifications	
Height	206 mm (8.10 in)
Width	269 mm (10.59 in)
Depth	69 mm (2.70 in)
Weight	1800 g (3.97 lbs)
Display	1280 x 800 pixels
Electrical Specifications	
Input	Verathon Supplied Battery, 10.95 V DC
Output	USB Ports, 5 V DC at 100 mA maximum from each port
Insulation	Type BF

Table 20. *BladderScan i10 Power Adapter (0400-0156)*

SPECIFICATION	DESCRIPTION
Electrical Specifications	
Input voltage	100–240 V AC, single phase
Input frequency	50–60 Hz
Input current	1.5 A max
Input connection	IEC C13 connection, line cord plug NEMA 5-15 (North America), AS 3112 (Australia), CEE 7/4 (Europe), BS 1363 (United Kingdom)
Output	19 V DC / 3.15 A / 60 W max
Approvals	IEC 60601-1

Table 21. *BladderScan i10 Probe (0570-0413)*

ITEM	SPECIFICATION
General Specifications	
Height	194 mm (7.64 in)
Width	61 mm (2.40 in)
Depth	89 mm (3.50 in)
Weight	470 g (1.04 lbs)
Cable	1.88 m (6.17 ft)
Mechanical Specifications	
Functional shock resistance	Passes a probe drop test that meets or exceeds a drop of 1.2 m (4 ft) to a steel surface using the MIL-STD 810H standard.

Table 22. *BladderScan i10 Printer (0800-0640)*

SPECIFICATION	DESCRIPTION
General Specifications	
Height	106 mm (4.17 in)
Width	103 mm (4.06 in)
Depth	122 mm (4.80 in)
Weight (without paper)	460 g (1.01 lbs)
Resolution	8 dots/mm (203 dots/in)
Dot size	0.125 mm by 0.12 mm (0.005 in by 0.005 in)
Printing width	48 mm (1.89 in), or 384 dots/line

Battery Specifications

The system includes a lithium-ion battery. A battery symbol on the touchscreen display is always present, indicating how much power remains and when the battery needs to be recharged or changed. If you have purchased additional batteries and the optional battery charger, you can change the battery whenever necessary.

Adhere to the following recommendations and guidance:

- Use only the console itself or the optional Verathon battery charger. Any other battery charger may damage the batteries.
- Use only the battery models described in this section.
- Consider replacement of the battery if the time between battery charges is significantly reduced and is affecting your use of the BladderScan i10 system. Contact Verathon Customer Care or your local representative to order replacement batteries.

Table 23. Battery (0400-0164)

CONDITION	DESCRIPTION	
General Specifications		
Battery type	Lithium Ion (Li-Ion)	
Height	23 mm (0.89 in)	
Width	151 mm (5.94 in)	
Depth	59 mm (2.32 in)	
Weight	326 g (0.72 lbs)	
Electrical Specifications		
Battery life	A fully charged battery will typically provide more than 24 hours of normal operating use between charges	
Charging time (typical)	Initial charge (15%–99%)	less than 5 hours
	Minimal charge (ready for first use, 5%–20%)	less than 30 minutes
	Typical recharge (5%–80%)	less than 3 hours
Rated capacity	7.0 Ah, 77 Wh	
Nominal voltage	10.95 V	
Max charging voltage	12.6 V	

Note: If you have one or more of the earlier 6.4 Ah / 70 Wh batteries (part number 0400-0155) or the 4.6 Ah / 51 Wh batteries (part number 0400-0126), you can use them with your BladderScan i10 systems as well. Be aware, however, that you will need to recharge them more frequently because of their lower storage capacities.

Battery Charger Specifications

Note: The battery charger is an optional accessory.

Table 24. Battery Charger (0400-0157)

SPECIFICATION	DESCRIPTION
General Specifications	
Height	58 mm (2.30 in)
Width	124 mm (4.89 in)
Depth	175 mm (6.89 in)
Weight	385 g (0.85 lbs)
Electrical Specifications	
Input voltage	24 V DC
Input frequency	DC
Input current	2.5 A
Input connection	2.5 mm (0.1 in), center positive
Output	18 V DC max, 4 A max
Insulation	Protection Class III
Fuses	No user replaceable fuses

Note: The BladderScan Prime Plus battery charger (part number 0400-0130) meets the same specifications as the optional battery charger available for BladderScan i10. It can be used to charge BladderScan i10 batteries.

Table 25. Battery Charger Power Adapter

SPECIFICATION	DESCRIPTION
Electrical Specifications	
Input voltage	100–240 V AC, single phase
Input frequency	50–60 Hz
Input current	1.4 A max
Input connection	IEC C13 connection, line cord plug NEMA 5-15 (North America), AS 3112 (Australia), CEE 7/4 (Europe), BS 1363 (United Kingdom)
Output	24 V DC / 0–2.71 A
Insulation	10 Megaohm for 500 V DC
Fuses	Automatic Over Voltage Protection (OVP), Short Circuit Protection (SCP), Over Current Protection (OCP)

Workstation Specifications

In Table 26, the maximum working loads for each component must be added together, and the sum of both loads must be less than or equal to the maximum total working load for the workstation as a whole.

LOAD ON TRAY	LOAD IN BIN	TOTAL LOAD	ACCEPTABLE
2.0 kg (4.41 lbs)	2.5 kg (5.51 lbs)	4.5 kg (9.92 lbs)	✓
4.5 kg (9.92 lbs)	None	4.5 kg (9.92 lbs)	✓
None	4.5 kg (9.92 lbs)	4.5 kg (9.92 lbs)	✓
2.5 kg (5.51 lbs)	2.5 kg (5.51 lbs)	5 kg (11.02 lbs)	✗

Note: The workstation is an optional accessory.

Table 26. BladderScan i10 Workstation (0800-0631)

SPECIFICATION	DESCRIPTION	
General Specifications		
Height	1556 mm (61.26 in)	
Pedestal diameter	627 mm (24.67 in)	
Weight (workstation, console, probe, printer, power adapter, and maximum total working load)	23 kg (50.7 lbs)	
Maximum total working load	4.5 kg (9.92 lbs)	
Maximum working load by component	Tray	4.5 kg (9.92 lbs)
	Accessory bin	4.5 kg (9.92 lbs)

Electromagnetic Compatibility

The system is designed to be in compliance with IEC 60601-1-2, which contains electromagnetic compatibility (EMC) requirements for medical electrical equipment. The limits for emissions and immunity specified in this standard are designed to provide reasonable protection against harmful interference in a typical facility.

The system complies with the applicable essential performance requirements specified in IEC 60601-1 and 60601-2-37. Results of immunity testing show that the essential performance of the system is not affected under the test conditions described in the following tables. For more information about the essential performance of the system, see “[Essential Performance](#)” on page 1.

Electromagnetic Emissions

Table 27. Guidance and Manufacturer’s Declaration—Electromagnetic Emissions

The system is intended for use in the electromagnetic environment specified below. The customer or the user of the system should ensure that it is used in such an environment.

EMISSIONS TEST	COMPLIANCE	ELECTROMAGNETIC ENVIRONMENT – GUIDANCE
RF emissions CISPR 11	Group 1	The system uses RF energy only for its internal function. Therefore, its RF emissions are very low and are not likely to cause any interference in nearby electronic equipment.
RF emissions CISPR 11	Class A	The system is suitable for use in all establishments other than domestic and those directly connected to the public low-voltage power supply network that supplies buildings used for domestic purposes.
Harmonic emissions IEC 61000-3-2	Class A	
Voltage fluctuations/ flicker emissions IEC 61000-3-3	In compliance	

Electromagnetic Immunity

Table 28. Guidance and Manufacturer's Declaration—Electromagnetic Immunity

The system is intended for use in the electromagnetic environment specified below. The customer or the user of the system should ensure that it is used in such an environment.

IMMUNITY TESTS	IEC 60601 TEST LEVEL	COMPLIANCE LEVEL	ELECTROMAGNETIC ENVIRONMENT – GUIDANCE
Electrostatic discharge (ESD) IEC 61000-4-2	± 8 kV contact ± 15 kV air	In compliance	Floors should be wood, concrete, or ceramic tile. If floors are covered with synthetic material, the relative humidity should be at least 30%.
Electrical fast transient/burst IEC 61000-4-4	± 2 kV for power supply lines 100 kHz repetition frequency	In compliance	Mains power quality should be that of a typical commercial or hospital environment.
Surge IEC 61000-4-5	± 1 kV line(s) to line(s) ± 2 kV line(s) to earth	In compliance	Mains power quality should be that of a typical commercial or hospital environment.
Voltage dips, short interruptions and voltage variations on power supply input lines IEC 61000-4-11	0% U_T ; 0.5 cycle At 0°, 45°, 90°, 135°, 180°, 225°, 270°, and 315° 0% U_T ; 1 cycle and 70% U_T ; 25/30 cycles Single Phase: at 0°	In compliance	Mains power quality should be that of a typical commercial or hospital environment. If the user of the system requires continued operation during power mains interruptions, it is recommended that the system be powered from an uninterruptible power supply or a battery.
Rated power frequency magnetic fields IEC 61000-4-8	30 A/m Frequency: 50/60 Hz	In compliance	Power frequency magnetic fields should be at levels characteristic of a typical location in a typical commercial or hospital environment.
Conducted RF IEC 61000-4-6	3 Vrms 150 kHz to 80 MHz 6 Vrms in ISM bands 150 kHz to 80 MHz 80% AM at 1 kHz	In compliance	Portable and mobile RF communications equipment should be used no closer to any part of the system, including cables, than the recommended separation distance calculated from the equation applicable to the frequency of the transmitter. Recommended separation distance d (m) $d=1.2 \sqrt{P}$

Table 28. Guidance and Manufacturer’s Declaration—Electromagnetic Immunity

The system is intended for use in the electromagnetic environment specified below. The customer or the user of the system should ensure that it is used in such an environment.

IMMUNITY TESTS	IEC 60601 TEST LEVEL	COMPLIANCE LEVEL	ELECTROMAGNETIC ENVIRONMENT – GUIDANCE
Radiated RF IEC 61000-4-3	3 V/m 80 MHz to 2.7 GHz 80% AM at 1 kHz	In compliance	Interference may occur in the vicinity of equipment marked with the following symbol: 

Note: U_T is the AC mains voltage prior to application of the test level.

These guidelines may not apply in all situations. Electromagnetic propagation is affected by absorption and reflection from structures, objects and people.

Recommended Separation Distances

Table 29. Recommended Separation Distances between Portable and Mobile RF Communications Equipment and the System

The system is intended for use in an electromagnetic environment in which radiated RF disturbances are controlled. The customer or the user of the system can help prevent electromagnetic interference by maintaining a minimum distance between portable and mobile RF communications equipment (transmitters) and the system as recommended below, according to the maximum output power of the communications equipment.

RATED MAXIMUM OUTPUT POWER OF TRANSMITTER (W)	SEPARATION DISTANCE ACCORDING TO FREQUENCY OF TRANSMITTER (m)		
	150 kHz to 80 MHz $d=1.2 \sqrt{P}$	80 MHz to 800 MHz $d=1.2 \sqrt{P}$	800 MHz to 2.5 GHz $d=2.3 \sqrt{P}$
0.01	0.12	0.12	0.23
0.1	0.38	0.38	0.73
1	1.2	1.2	2.3
10	3.8	3.8	7.3
100	12	12	23

For transmitters rated at a maximum output power not listed above, the recommended separation distance d in meters (m) can be estimated using the equation applicable to the frequency of the transmitter, where P is the maximum output power rating of the transmitter in watts (W) according to the transmitter manufacturer.

Note: At 80 MHz and 800 MHz, the separation distance for the higher frequency range applies.

These guidelines may not apply in all situations. Electromagnetic propagation is affected by absorption and reflection from structures, objects, and people.

Accessory Conformance to Standards

To maintain electromagnetic interference (EMI) within certified limits, the system must be used with the cables, components, and accessories specified or supplied by Verathon. For additional information, see the [Components & Accessories](#) section on page 10 and the [Product Specifications](#) section on page 80.

The use of accessories or cables other than those specified or supplied may result in increased emissions or decreased immunity of the system.

Table 30. EMC Standards for Accessories

ACCESSORY	LENGTH
Probe cable	1.8 m (6.0 ft)
USB printer cable	1.7 m (5.6 ft)
AC power cord	4.5 m (15.0 ft)
Power adapter cable	1.5 m (4.9 ft)

Glossary

This table provides definitions for specialized terms used in this manual or on the product itself. For a full list of caution, warning, and informational symbols used on this and other Verathon products, refer to the *Verathon Symbol Glossary* at verathon.com/symbols.

TERM	DEFINITION
A	Ampere
A_{APRT}	Active aperture area
Ah	Ampere hour
ALARA	As low as reasonably achievable
Anatomical features	Organs or structures of the body
Ascites	A buildup of excess fluid in the peritoneal cavity of the abdomen
B-mode	Display mode showing the target of a current or saved scan as an ultrasound image.
C	Celsius
C-mode	Display mode showing the target of a current or saved scan as crosshairs over an area of color.
cm	Centimeter
DC	Direct current
EDS	Entrance dimensions of the scan
EHR	Electronic Health Record
EMR	Electronic Medical Record
EMC	Electromagnetic compatibility
EMI	Electromagnetic interference
Essential performance	The system performance necessary to achieve freedom from unacceptable risk
ESD	Electrostatic discharge
F	Fahrenheit
f_{awf}	Acoustic working frequency (definition 3.4, IEC 62359:2010)
f_c	Center frequency
FDA	Food and Drug Administration (federal agency in U.S.)
Fetal patient	A fetus in the uterus of a pregnant patient
g	Gram
GHz	Gigahertz
hPa	Hectopascal
Hz	Hertz
IEC	International Electrotechnical Commission
in	Inch
kHz	Kilohertz
I_{sppa}	Spatial-peak, pulse-average intensity

TERM	DEFINITION
I_{spta}	Spatial-peak, temporal-average intensity
m	Meter
MHz	Megahertz
MI	Mechanical index
mL	Milliliter
mm	Millimeter
MPa	Megapascal
mW	Milliwatt
μ sec	Microsecond
OCP	Over current protection
OVP	Automatic over voltage protection
P_o	Ultrasonic power
PD	Pulse duration
$P_{r,3}$	Derated peak rarefactional pressure
PRF	Pulse repetition frequency
RF	Radio frequency
SCP	Short circuit protection
TI	Thermal index (definition 3.56, IEC 62359:2010)
TIB	Bone thermal index (definition 3.17, IEC 62359:2010)
TIC	Cranial bone thermal index (definition 3.21, IEC 62359:2010)
TIS	Soft tissue thermal index (definition 3.52, IEC 62359:2010)
UTI	Urinary tract infection
V	Volt
W	Watt
Wh	Watt hour
WEEE	Waste Electrical and Electronic Equipment
Z_{sp}	Axial distance at which the reported parameter is measured

verathon