



GlideScope® Video Laryngoscopes

Operations & Maintenance Manual

GlideScope

Video Laryngoscopes

Operations & Maintenance Manual

Effective: January 21, 2025

Caution: Federal (United States) law restricts this device to sale by or on the order of a physician.

Contact Information

To obtain additional information regarding your GlideScope system, please contact Verathon Customer Care or visit verathon.com/service-and-support.

Verathon Inc.

20001 North Creek Parkway
Bothell, WA 98011 U.S.A.
Tel: +1 800 331 2313 (US and Canada only)
Tel: +1 425 867 1348
Fax: +1 425 883 2896
verathon.com



Verathon Medical (Canada) ULC

2227 Douglas Road
Burnaby, BC V5C 5A9
Canada
Tel: +1 604 439 3009
Fax: +1 604 439 3039



Verathon Medical (Europe) B.V.

Willem Fenengastraat 13
1096 BL Amsterdam
The Netherlands
Tel: +31 (0) 20 210 30 91
Fax : +31 (0) 20 210 30 92

Verathon Medical (Australia) Pty Limited

Unit 9, 39 Herbert Street
St Leonards NSW 2065
Australia
Within Australia: 1800 613 603 Tel / 1800 657 970 Fax
International: +61 2 9431 2000 Tel /
+61 2 9475 1201 Fax



MDSS CH GmbH

Laurenzenvorstadt 61
5000 Aarau
Switzerland



Anandic Medical Systems AG

Stadtweg 24
8245 Feuerthalen
Switzerland



MDSS-UK RP Ltd.

6 Wilmslow Road, Rusholme
Manchester M14 5TP
United Kingdom
Tel: +44 (0)7898 375115



Copyright © 2025 by Verathon Inc. All rights reserved. No part of this manual may be copied or transmitted by any method without the express written consent of Verathon Inc.

GlideScope, the GlideScope symbol, GVL, Core, Spectrum, Spectrum QC eco, Reveal, and Verathon, are trademarks of Verathon Inc. All other brand and product names are trademarks or registered trademarks of their respective owners.

Not all Verathon Inc. products shown or described in this manual are available for commercial sale in all countries.

Information in this manual may change at any time without notice. For the most up-to-date information, see the documentation available at verathon.com/service-and-support.

Table of Contents

- IMPORTANT INFORMATION 1**
 - Product Information 1
 - Statement of Intended Use 1
 - Essential Performance 1
 - Environments of Intended Use 1
 - Statement of Prescription 1
 - Notice to All Users 1
 - Warnings & Cautions 2

- BLADES, BATONS, & CABLES 8**
 - Video Laryngoscopes 8
 - Video Cables 11
 - Compatibility 12

- COMPONENTS 14**
 - Video Laryngoscopes 14
 - Batons 15
 - Video Cables 15

- SETTING UP 16**
 - Procedure 1. Perform Initial Inspection* 16
 - Procedure 2. Attach the Video Cable to the Monitor* 17
 - Procedure 3. Attach the Scope to the Video Cable* 18
 - Procedure 4. Perform a Functional Check* 19

- USING THE DEVICE 20**
 - Procedure 1. Prepare the Scope* 20
 - Procedure 2. Intubate the Patient* 22
 - Procedure 3. Prepare a Component for Cleaning* 23

REPROCESSING24

MAINTENANCE & SAFETY25

 Periodic Inspections25

 Elution Compatibility25

 Device Repair25

 Device Disposal25

LIMITED WARRANTY26

PRODUCT SPECIFICATIONS28

 Component Specifications28

 Electromagnetic Compatibility49

GLOSSARY52

Important Information

This manual details how to use video laryngoscopes that are compatible with the GlideScope Video Monitor (GVM), GlideScope Core monitors, and the GlideScope Go 2 monitor.

Product Information

GlideScope video laryngoscopes combine innovative designs in reusable and single-use options to enable intubations across a wide range of patient types, weights, and clinical settings. GlideScope video laryngoscopes are designed to deliver high-resolution airway views when used with compatible GlideScope video monitors.

For manuals specific to your video monitor, please visit [verathon.com/service-and-support](https://www.verathon.com/service-and-support), or contact Verathon Customer Care. For information on monitor, cable, and scope compatibility, see [Compatibility](#) on page 12.

Statement of Intended Use

These components are intended for use by qualified professionals to obtain a clear, unobstructed view of the airway and vocal cords for medical procedures.

Essential Performance

Essential performance is the system performance necessary to achieve freedom from unacceptable risk. When connected with an appropriate monitor, the essential performance of these components is to provide a clear view of the vocal cords.

Environments of Intended Use

GlideScope systems are intended to be used in professional healthcare environments such as hospitals.

With the exception of the Video Baton QC Large, GlideScope video laryngoscopes compatible with the GlideScope Go 2 monitor may additionally be used in Emergency Medical Services (EMS) environments, and have been tested to work in the following ambulance types: van, pickup truck, bus, and aircraft (helicopter and fixed wing).

Statement of Prescription

Caution: Federal (United States) law restricts this device to sale by or on the order of a physician.

These components should be used only by individuals who have been trained and authorized by a physician or used by healthcare providers who have been trained and authorized by the institution providing patient care.

Notice to All Users

Verathon recommends that all users read this manual before using these components. Failure to do so may result in injury to the patient, may compromise the performance of the system, and may void the system warranty. Verathon recommends that new GlideScope users:

- Obtain instruction from a qualified individual
- Practice using the system on a mannequin before clinical use
- Acquire clinical experience on patients without airway abnormalities

Warnings & Cautions

Warnings indicate that injury, death, or other serious adverse reactions may result from use or misuse of the device. *Cautions* indicate that use or misuse of the device may cause a problem, such as a malfunction, failure, or damage to the product. Throughout the manual, pay attention to sections labeled *Important*, as these contain reminders or summaries of the following cautions as they apply to a specific component or use situation. Please heed the following warnings and cautions.

Warnings: Use



WARNING

Before every use, ensure that the instrument is operating correctly and has no sign of damage. Do not use this product if the device appears damaged. Refer servicing to qualified personnel.

Always ensure that alternative airway management methods and equipment are readily available.

Report any suspected defects to Verathon Customer Care. For contact information, visit verathon.com/service-and-support.



WARNING

Portable radio frequency communications equipment (including peripherals such as antenna cables and external antennas) may not be used within 30 cm (12 inches) of any part of the system, including cables that Verathon specifies or provides for use with the system. If this distance is not maintained, performance of the system may be degraded and image display may be compromised.



WARNING

When you are guiding the endotracheal tube to the distal tip of the video laryngoscope, ensure that you are looking in the patient's mouth, not at the screen. Failure to do so may result in injury, such as to the tonsils or soft palate.



WARNING

Do not place the video baton in the cradle if any of the components are contaminated.



WARNING

The area surrounding the camera in the video laryngoscope can contact the patient and can exceed 41°C (106°F) as part of normal operation. Patient contact with this area of the blade during intubation is unlikely, as it would cause an obstruction of the camera view. Do not maintain continuous contact with this area of the blade for longer than 1 minute; it is possible to cause thermal damage such as a burn to the mucosal tissue.

Warnings: Reprocessing



WARNING

Reusable video laryngoscopes and video cables are delivered nonsterile and require cleaning and disinfection prior to initial use.



WARNING

Cleaning is critical to ensuring a component is ready for disinfection or sterilization. Failure to properly clean the device may result in a contaminated instrument after completing the disinfection or sterilization procedure.

When cleaning, ensure all foreign matter is removed from the surface of the device. This allows the active ingredients of the chosen disinfection method to reach all the surfaces.



WARNING

This product may only be cleaned, disinfected, or sterilized by using the approved processes provided in the GlideScope and GlideRite Products Reprocessing Manual (part number 0900-5032). Cleaning, disinfection, and sterilization methods listed are recommended by Verathon based on efficacy or compatibility with component materials.



WARNING

Availability of cleaning, disinfection, and sterilization products varies by country, and Verathon is unable to test products in every market. For more information, please contact Verathon Customer Care. For contact information, visit verathon.com/service-and-support.



WARNING

The reusable Titanium video laryngoscope is considered a semi-critical device intended to contact the airway. It must be thoroughly cleaned and undergo high-level disinfection after each use.



WARNING

Because the product may be contaminated with human blood or body fluids capable of transmitting pathogens, all cleaning facilities must be in compliance with (U.S.) OSHA Standard 29 CFR 1910.1030 “Bloodborne Pathogens” or an equivalent standard.



WARNING

Do not reuse, reprocess, or resterilize single-use components. Reuse, reprocessing, or resterilization can contaminate the component or the GlideScope system.



WARNING

For information on the handling and disposing of recommended reprocessing solutions, please refer to the solution manufacturer’s instructions.



WARNING

Make sure each component is completely clean before you disinfect or sterilize it. If it is not, the disinfection or sterilization procedure may not remove all contamination. This increases the risk of infection.



WARNING

Do not reuse, reprocess, or resterilize single-use components. Reuse, reprocessing, or resterilization may create a risk of contamination of the device.

Warnings: Product Safety



WARNING

To reduce the risk of electrical shock, use only the accessories and peripherals recommended by Verathon.



WARNING

Electric shock hazard. Do not attempt to open the system components. This may cause serious injury to the operator or damage to the instrument and voids the warranty. Contact Verathon Customer Care for all servicing needs.



WARNING

Use of accessories and cables other than those specified or provided by Verathon may cause this system to experience electromagnetic malfunctions, including increased emissions or decreased immunity. This may cause improper operation, procedure delays, or both.



WARNING

No modification of this equipment is allowed.

Cautions



CAUTION

The system contains electronics that may be damaged by ultrasonic and automated washing equipment. Do not use an ultrasonic device or automated washing equipment, other than Verathon-approved systems, to clean this product.



CAUTION

When cleaning video laryngoscopes, do not use metal brushes, abrasive brushes, scrub pads, or rigid tools. They will scratch the surface of the unit or the window protecting the camera and light, which may permanently damage the device.



CAUTION

Bleach may be used on the video batons, but pay special attention to stainless steel components, as bleach can corrode stainless steel.



CAUTION

Do not use a knife or other sharp instrument to open packaging containing single-use video laryngoscopes, and do not use such components if their packaging is damaged.



CAUTION

European Union only: If any serious incident occurs during use of this product, you must immediately notify Verathon (or its authorized representative), the Competent Authority of the Member State where the incident occurred, or both.



CAUTION

Medical electrical equipment requires special precautions regarding electromagnetic compatibility (EMC) and must be installed and operated according to the instructions in this manual. For more information, see the Electromagnetic Compatibility section.

Avoid using the GlideScope system adjacent to or stacked with other equipment. If adjacent or stacked use is necessary, observe the system to verify normal operation in the configuration in which it will be used.

This device can radiate radio frequency energy and is highly unlikely to cause harmful interference with other devices in the vicinity. There is no guarantee that interference will not occur in a particular installation. Evidence of interference may include degradation of performance in this device or other devices when operated simultaneously. If this occurs, try to correct the interference by using the following measures:

- Turn devices on and off in the vicinity to determine the source of interference
- Reorient or relocate this device or other devices
- Increase the separation between devices
- Connect the device to an outlet on a circuit different than the other device(s)
- Eliminate or reduce EMI with technical solutions (such as shielding)
- Purchase medical devices that comply with IEC 60601-1-2 EMC standards

Be aware that portable and mobile radio frequency communications equipment (cellular phones, etc.) may affect medical electrical equipment; take appropriate precautions during operation.

Cautions: Reprocessing



CAUTION

Do not return GlideScope system components to their storage locations until they have been thoroughly cleaned, and disinfected or sterilized if appropriate. Returning contaminated components to these locations increases the risk of infection.



CAUTION

For recommendations on the handling and disposal of a reprocessing agent, refer to the manufacturer's instructions for the reprocessing agent.



CAUTION

The reusable components of GlideScope systems are not shipped in sterile condition. Clean them, and disinfect or sterilize them if appropriate, before their first use. Failure to do so increases the risk of infection.

**CAUTION**

Do not use abrasive brushes, pads, or tools when cleaning cameras or screens. These items can scratch transparent plastic parts and permanently damage the device.

**CAUTION**

Do not use an ultrasonic device or automated washing equipment to clean a Verathon product, except when using Verathon-approved systems to clean products compatible with those systems. Using ultrasonic or automated washing equipment to clean any other Verathon product, or using automated cleaning systems not listed as compatible, could damage the product.

**CAUTION**

Risk of permanent equipment damage. This product is sensitive to heat, which causes damage to the electronics. Do not expose the system to temperatures above 60°C (140°F), and do not use autoclaves or pasteurizers. Use of such methods to clean, disinfect, or sterilize the system causes permanent device damage and voids the warranty. For a list of approved cleaning procedures and products, see the GlideScope and GlideRite Products Reprocessing Manual (part number 0900-5032).

Blades, Batons, & Cables

GlideScope video laryngoscopes are available in the following formats:

- GlideScope Titanium Reusable video laryngoscopes
- GlideScope Spectrum Single-Use video laryngoscopes
- GlideScope Spectrum QC Single-Use video laryngoscopes
- GlideScope AVL Video Batons for use with Single-Use GVL Stats (blades)
- GlideScope Video Baton 2.0 for use with Single-Use GVL Stats (blades)
- GlideScope Video Baton QC for use with Single-Use GVL Stats (blades)

Note: For information on approximate weight ranges for reusable video laryngoscopes, single-use video laryngoscopes, and GVL Stats, see the procedure [Prepare the Scope](#) on page 20.

Video Laryngoscopes

Titanium Reusable Video Laryngoscopes

GlideScope Titanium reusable video laryngoscopes are made from durable/lightweight titanium, which enable low-profile blade designs for optimized maneuverability and working space. The video laryngoscope is connected to the video monitor via a reusable video cable. Titanium reusable video laryngoscopes are available in a uniquely angulated LoPro style, and in Mac style as well.

Figure 1. GlideScope Titanium Reusable Video Laryngoscopes





Spectrum Single-Use Video Laryngoscopes

The Spectrum and Spectrum QC single-use video laryngoscopes are fully disposable video laryngoscopes that integrate the latest advancements in lighting technology to optimize image brightness and clarity throughout the intubation process. These single-use video laryngoscopes are connected to cart-based video monitors via a Smart Cable or QuickConnect cable and are available in uniquely angulated LoPro (Spectrum) and Hyperangulated (Spectrum QC) styles, and in Miller and Mac styles as well.

Spectrum LoPro S3, LoPro S4, Hyperangle S3, Hyperangle S4, DirectView MAC S3, DirectView MAC S4 are compatible with the Dynamic Light Control feature available on GlideScope Core monitors.





Spectrum QC and Spectrum QC eco are equivalent in terms of functionality, operations, and maintenance.

Table 1. GlideScope Monitor and Connector Compatibility

CONNECTOR TYPE	COMPATIBILITY			
	GlideScope Core	GlideScope Video Monitor	GlideScope Go	GlideScope Go 2
 QuickConnect (Spectrum QC)	●			●
 HDMI (Spectrum Single-Use)	●	●	●	

Note: For information on which cables to use when connecting these video laryngoscopes to the GlideScope Core Monitor or the GlideScope Video Monitor, refer to the [Compatibility](#) section.

Figure 2. Single-Use Video Laryngoscopes

						
Connector	Size	LoPro	Hyperangle	MAC	DirectView MAC	Miller
 Spectrum Single-Use	S00					
	S0					●
	S1	●				●
	S2	●				
	S2.5	●				
	S3	●				●
	S4	●				●
	S5					
 Spectrum QC	S00					●
	S0					●
	S1		●	●		●
	S2		●	●		●*
	S2.5		●			
	S3		●*	●*		
	S4		●	●		
	S5					

* Example image

Video Batons & Stats

Reusable video batons combine a high-resolution, full-color digital camera with an integrated LED light source and Reveal anti-fog feature. Video batons are connected to cart-based video monitors via a permanently-integrated video cable (AVL Video Batons), or a separate Smart Cable (Video Baton 2.0). Video batons are available with a choice of two sizes and are designed to be used with single-use GVL Stats. GVL Stats are offered in a comprehensive range of sizes, allowing clinicians to meet the particular requirements of a wide range of patients.

Each GVL Stat size is designed for a specific video baton size, as shown in Table 2.

Table 2. AVL Video Baton and GVL Stat Compatibility

VIDEO BATON SIZE	COMPATIBLE GVL STAT SIZES					
	0	1	2	2.5	3	4
1-2	●	●	●	●		
3-4 (Large)					●	●

Figure 3. Video Batons



Figure 4. Single-Use Stats

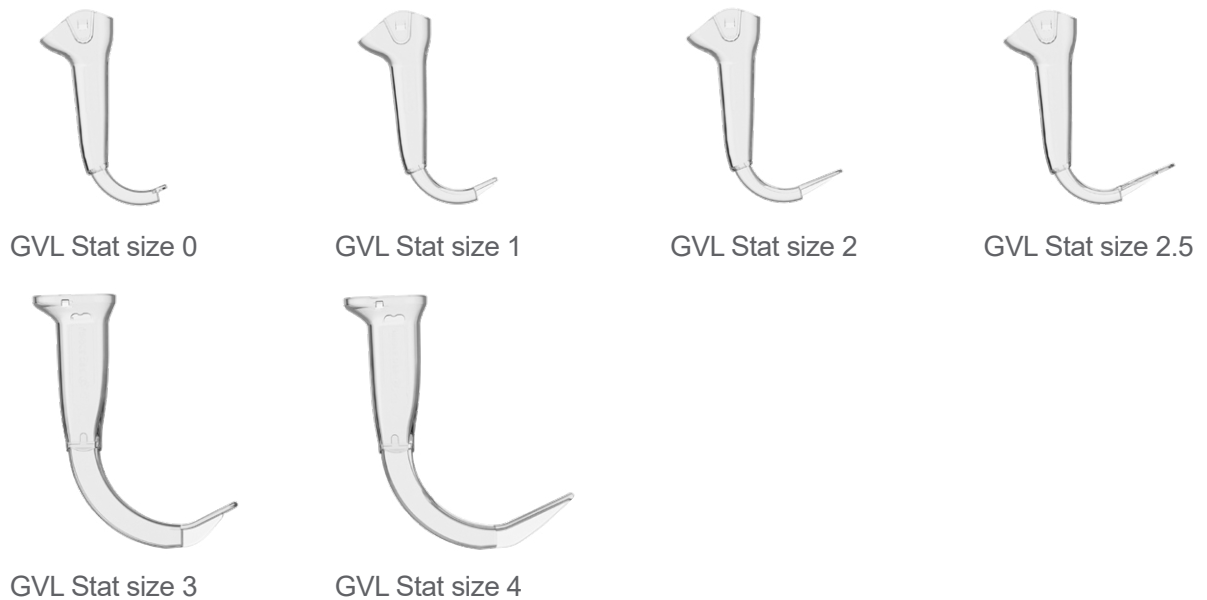

Video Cables

IMPORTANT

When using a Core 2m QuickConnect Cable, ensure the Core 15 monitor software is updated to the following versions or later:

- Version 1.8—Core 15 FHD (0570-0437)
- Version 1.10—Core 15 (0570-0404)

The video laryngoscopes in this manual require a video cable to connect to cart-based monitors. In this document, unless otherwise noted, the term *video cable* describes both Smart Cables and video cables. For information on compatibility between video laryngoscopes, batons, cables, and monitors, see [Compatibility](#) on page 12.

Figure 5. *GlideScope Cables**

Spectrum Smart Cable



Titanium Video Cable



GlideScope Core Video Cable



GlideScope Core Smart Cable



GlideScope Core QuickConnect Cable



GlideScope Core 2m QuickConnect Cable



* Cables have been shortened for illustrative purposes. For cable dimensions, see [Component Specifications](#) on page 28

Compatibility

GlideScope components may be compatible with other GlideScope product lines. The following tables show the component compatibility between monitors, video cables, and scopes. For information specific to your monitor, see verathon.com/service-and-support, or contact Verathon Customer Care.

Table 3. *GlideScope Core Compatibility*











MONITOR	VIDEO CABLE		SCOPE
<p data-bbox="277 884 488 915">GlideScope Core</p> 	<p data-bbox="613 464 756 491">To Monitor</p> <p data-bbox="883 464 1003 491">To Scope</p> <p data-bbox="631 495 992 522">GlideScope Core Video Cable</p>		<p data-bbox="1138 474 1442 504">Titanium reusable blades</p> 
	<p data-bbox="613 672 756 699">To Monitor</p> <p data-bbox="883 672 1003 699">To Scope</p> <p data-bbox="631 703 992 730">GlideScope Core Smart Cable</p>		<p data-bbox="1114 686 1450 716">Video Baton 2.0 Large (3-4)</p>  <p data-bbox="1117 846 1463 875">Spectrum Single-Use blades</p> 
	<p data-bbox="613 1029 756 1056">To Monitor</p> <p data-bbox="883 1029 1003 1056">To Scope</p> <p data-bbox="586 1068 1040 1136">GlideScope Core QuickConnect cable and Core 2m QuickConnect cable</p>		<p data-bbox="1149 1165 1425 1194">Video Baton QC Large</p>  <p data-bbox="1092 1325 1487 1354">Spectrum QC Single-Use blades</p> 

Table 4. *GlideScope Video Monitor (GVM) Compatibility*

MONITOR	VIDEO CABLE		SCOPE
	To Monitor	To Scope	
<p>GlideScope Video Monitor</p> 	<p>Titanium Video Cable</p> 		<p>Titanium Reusable</p> 
	<p>Spectrum Smart Cable</p> 		<p>Video Baton 2.0 Large (3-4)</p>  <p>Spectrum Single-Use blades</p> 
			<p>Video Baton 3-4</p> 
			<p>Video Baton 1-2</p> 

Table 5. *GlideScope Go 2 Compatibility*

MONITOR	VIDEO CABLE		SCOPE
	To Monitor	To Scope	
	<p>No cable. Direct connection.</p> 		<p>Video Baton QC Large</p>  <p>Spectrum QC Single-Use blades</p> 

Components

Video Laryngoscopes

Figure 6. Titanium & Spectrum Video Laryngoscope Components

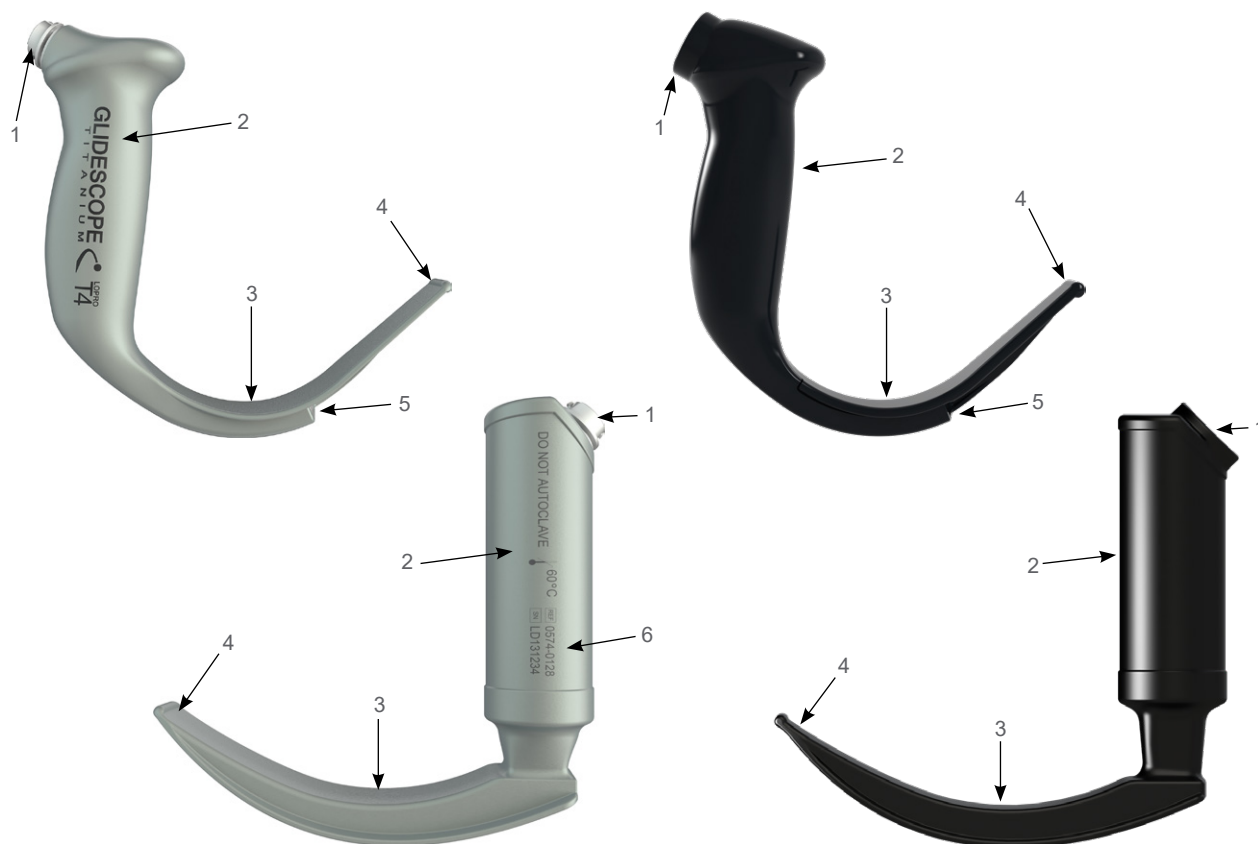

Table 6. Video Laryngoscope Components

FIGURE KEY	COMPONENT	NOTES
1	Connector	—
2	Handle	—
3	Blade	Various styles, sizes, and construction.
4	Distal tip	—
5	Camera and light	High-resolution, full-color camera with integrated LED light source
6	Product number and serial number	On the left side of the handle of reusable video laryngoscopes.

Batons

Figure 7. Video Baton Components

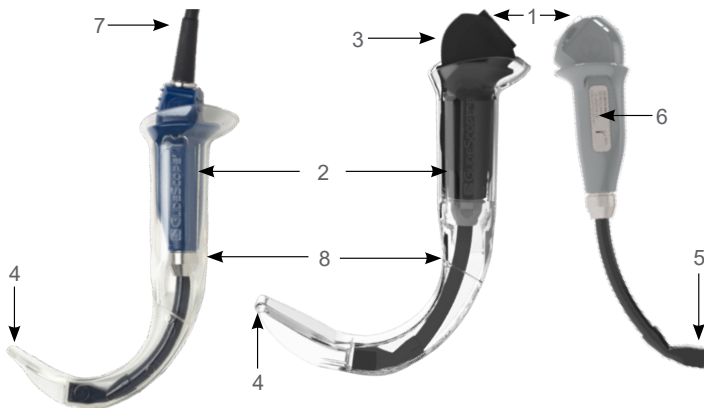

Table 7. Video Baton Components

FIGURE KEY	COMPONENT	NOTES
1	Connector	—
2	Handle	—
3	Baton	Reusable camera compatible with Single-Use GVL Stats.
4	Distal tip	—
5	Camera and light	High-resolution, full-color camera with integrated LED light source.
6	Label	Product number and serial number. Located the right side of the video baton handle.
7	Video cable	—
8	Single-Use GVL Stat	—

Video Cables

Figure 8. Video Cable Components



Table 8. Video Cable Components

FIGURE KEY	COMPONENT	NOTES
1	Connector	Cables are available with several connector configurations. For more information, see Compatibility on page 12.
2	Cable*	—
3	Electronics	Smart cables only.

* Cable have been shortened for illustrative purposes.

Setting Up



Please read the [Warnings & Cautions](#) section before performing the following tasks.

This chapter contains information on connecting a video monitor, video cable, and scope. The video cable attaches the scope to the monitor, supplying power to the component and transmitting video data from the scope's camera to the monitor.

Before you can use the system for the first time, you must inspect the components, set up the system, and perform a functional test as recommended by Verathon. Complete the following procedures:

1. **Perform Initial Inspection**—Inspect components for any obvious physical damage that may have occurred during shipment.
2. **Attach the Video Cable to the Monitor**—Attach the video cable that provides power to the scope, and transmits the video signal to the monitor.
3. **Attach the Scope to the Video Cable**—Attach the scope that houses the camera and light.
4. **Perform a Functional Check**—Before you use the device for the first time, perform a functional check to ensure that the system is working properly.

Procedure 1. Perform Initial Inspection

When you receive a component, Verathon recommends that an operator familiar with it perform a full visual inspection for any obvious physical damage that may have occurred during shipment.

1. Verify that you have received the appropriate components for your system by referring to the packing list included with the system.
2. Inspect the components for damage.
3. If any of the components are missing or damaged, notify the carrier and Verathon Customer Care or your local representative. For contact information, visit verathon.com/service-and-support.

Procedure 2. Attach the Video Cable to the Monitor

This procedure provides basic instruction on connecting video cables to a monitor. For detailed information about compatible monitors, see [Compatibility](#) on page 12. For information on a specific monitor, please refer to its Operations & Maintenance Manual, or contact Verathon Customer Care.

Option 1. GlideScope Video Monitor

1. Ensure the video monitor is turned off prior to connecting or disconnecting the video cable or Smart Cable.
2. Align the arrow on the video cable and the arrow on the video cable port, and then insert the cable into the port. You will hear a click when the cable is successfully connected.

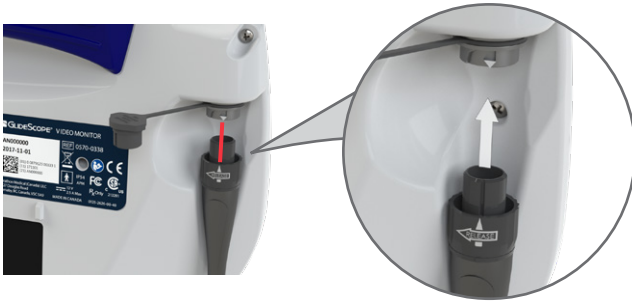

3. To disconnect the video cable from the monitor, rotate the connector ring in the direction of the release arrow, and then remove the connector from the port.



Option 2. Core Video Monitor

1. Align the dot on the cable connector to the dot on one of the monitor's video connectors, and then fully insert the cable. The connector attaches to the monitor with magnets.

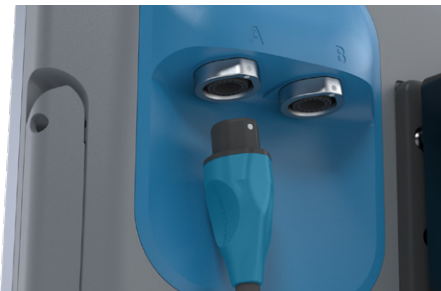

2. To disconnect the video cable, hold the cable connector in one hand and support the monitor with the other, and then pull. The cable disconnects from the monitor.

Option 3. Go 2 Video Monitor

1. Align the mark on the monitor with the mark on the baton or single-use blade, and then insert the blade/baton connector fully into the connector port on the blade or baton.

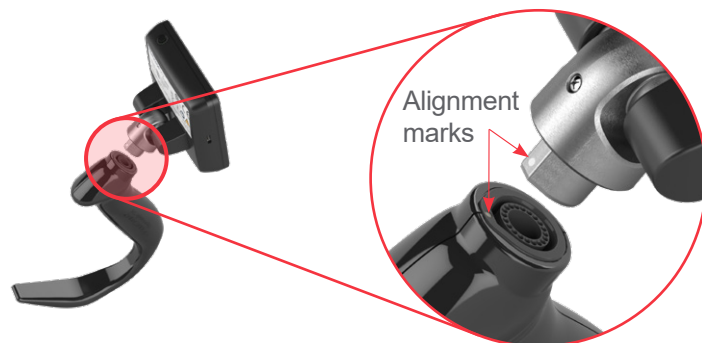

2. To disconnect the scope from the monitor, hold the scope in one hand the monitor with the other, and then pull. The scope disconnects from the monitor.

Procedure 3. Attach the Scope to the Video Cable

Option 1. Video Cables for Reusable Video Laryngoscopes

1. Bring into line the alignment marks on the video cable and scope connectors, and then fully insert the video cable into the scope connector port. You will hear a click when the cable is successfully connected.

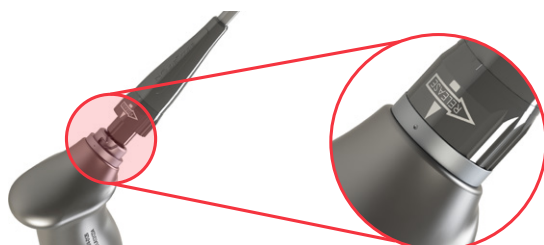

2. To disconnect the scope from the video cable, hold the scope in one hand, twist the cable's locking collar in the direction specified by the arrow on the collar, and then pull. The scope disconnects from the cable.

Option 2. Smart and QuickConnect Cables

It is recommended that you leave single-use accessories in their packaging while connecting the cable and that you do not remove it until you are ready to perform the procedure. This helps ensure that the blade remains as clean as possible until you are ready to use it.

1. Bring into line the alignment marks on the video cable and scope connectors, and then fully insert the video cable into the scope connector port.



2. To disconnect the scope from the video cable, hold the cable connector in one hand and the scope's body in the other, and then pull. The video component disconnects from the cable.

Procedure 4. Perform a Functional Check

Before you use the device for the first time, perform the following functional check to ensure that the system is working properly. Please contact your local Verathon representative or Verathon Customer Care if your system does not function as described below. For contact information, visit verathon.com/service-and-support.

1. Fully charge the monitor battery (this may take up to approximately 6 hours).
2. Attach a video cable and scope to the monitor. For information on cable and scope configurations that are compatible with your monitor, see [Setting Up](#) on page 16.
3. Press the **Power** button. The monitor turns on.
4. Verify the scope's LED is on.



5. Look at the monitor screen, and verify that the image displayed is being received from the scope.

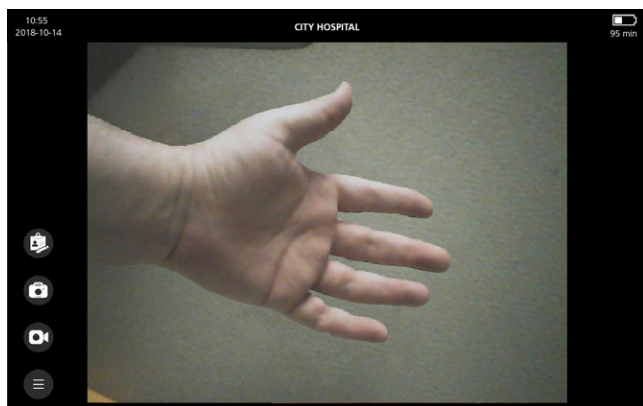

Note: There may be a slight blade intrusion in the upper-left corner of the monitor, and a thin line may appear along the top. These blade edges are captured in the view because of the wide-angle camera lens used in the video laryngoscope. This image acts as a frame of reference during the intubation process and ensures that the orientation of the image is correct in the monitor.

6. To complete a functional check on the monitor, see the **Perform a Functional Check** procedure in your monitor's operations and maintenance manual.

Using the Device



Please read the [Warnings & Cautions](#) section before performing the following tasks.

Prior to using the device, set up the device according to the instructions in the chapter [Setting Up](#), and then verify the setup by completing the procedure [Perform a Functional Check](#).

Video batons and Reusable Titanium video laryngoscopes are equipped with the Reveal anti-fog feature, which reduces camera fogging during the intubation procedure. To fully optimize the feature, you must allow the video laryngoscope to warm up for 30-120 seconds prior to use, depending on the ambient temperature and humidity of the clinical environment. Full optimization of the anti-fog feature is not necessary in order to use the device; if desired, you may begin the intubation procedure immediately.

Note: If the video laryngoscope is stored in cold conditions, additional warming time may be required for optimal performance of the anti-fog feature.

This chapter consists of the following procedures:

- [Prepare the Scope](#)
 - [Option 1: Video Batons](#)
 - [Option 2: Reusable & Single-Use Video Laryngoscopes](#)
- [Intubate the Patient](#)
 - [Option 1: LoPro Blade or GVL Stat](#)
 - [Option 2: Mac-Style or Miller-Style Blade](#)

Procedure 1. Prepare the Scope

IMPORTANT

Ensure that each component has been properly cleaned, disinfected, or sterilized according to the guidance provided in the [Reprocessing](#) chapter.

Option 1. Video Batons

Ensure that the video monitor is turned off prior to connecting or disconnecting the video cable.

1. Based on a clinical assessment of the patient and the experience and judgment of the clinician, select the video baton and GVL Stat combination that is appropriate for the patient.
2. Attach the video cable and video laryngoscope to the monitor, according to the instructions in [Attach the Video Cable to the Monitor](#) on page 17.
3. If you are using a Video Baton 2.0 Large (3-4), attach the baton to the cable, according to the instructions in [Attach the Scope to the Video Cable](#) on page 17.
4. Turn on the video monitor.
5. Ensure that the battery is sufficiently charged. If necessary, connect the monitor directly to power.

Insert the Video Baton into the GVL Stat

6. Open the GVL Stat pouch, but do not remove the Stat from the packaging.
7. Ensure that the logo on the side of the baton and the logo on the side of the Stat are aligned.
8. Slide the video baton into the GVL Stat until it clicks into place. Do not remove the Stat from the pouch until you are ready to begin the intubation. This ensures that the Stat remains as clean as possible.

Note: Ensure that you do not insert the video baton backwards.

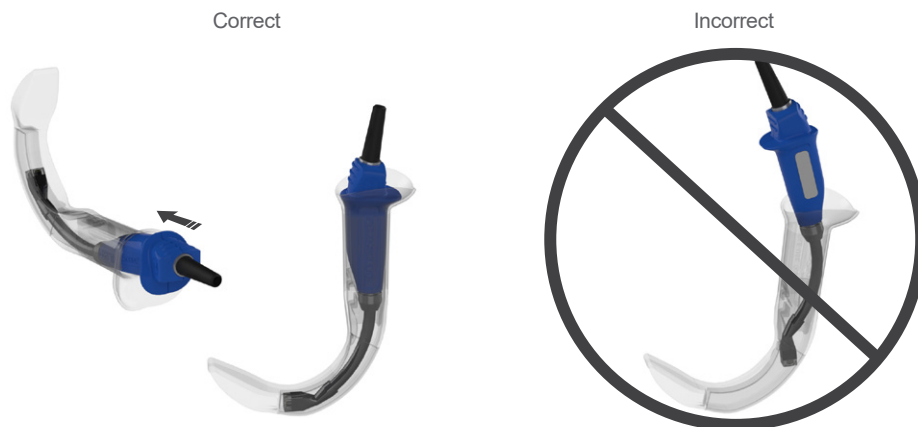

9. When you remove the GVL Stat from the packaging, visually inspect the Stat to ensure that all exterior surfaces are free of unintended rough areas, sharp edges, protrusions, or cracks.

Option 2. Reusable & Single-Use Video Laryngoscopes

1. Based on a clinical assessment of the patient and the experience and judgment of the clinician, select the GlideScope video laryngoscope that is appropriate for the patient.
2. Attach the video cable and video laryngoscope to the monitor, according to the instructions in [Attach the Video Cable to the Monitor](#) on page 17.
3. Turn on the video monitor.
4. Ensure that the battery is sufficiently charged. If necessary, connect the monitor directly to power.
5. On the monitor screen, verify that the image displayed is from the video laryngoscope camera. A small portion of the blade may be visible on the upper-left corner or top of the monitor screen.
6. If needed, allow the anti-fog feature to warm up for 30–120 seconds.

Note: The time required for the anti-fog feature to be fully optimized varies according to the ambient temperature and humidity where the equipment is being stored or used. If the video laryngoscope is stored in cold conditions, additional warming time may be required for optimal performance of the anti-fog feature.

7. If desired to provide additional anti-fog benefits, you may apply Dexide Fred or Dexide Fred Lite to the camera window on the reusable blade.* Use the solution according to the manufacturer's instructions.

* Compatibility has been demonstrated for up to 100 cycles on reusable video laryngoscopes.

Procedure 2. Intubate the Patient



Please read the [Warnings & Cautions](#) section before performing the following tasks.

To perform an intubation, Verathon recommends using one of the following techniques appropriate for the style laryngoscope being used. Prior to beginning this procedure, verify that the monitor is receiving an accurate image from the video laryngoscope.

Option 1. LoPro Blade or GVL Stat

If you are using a Mac-style or Miller-style blade, skip to the next option, Mac-Style or Miller-Style Blade.

1. Stabilize the patient's head.
2. Look in the mouth, insert the blade midline, and then advance the tip into the vallecula.
3. Look at the screen, and then lift the epiglottis for a view of the larynx.
4. Look in the mouth, and then introduce an endotracheal tube alongside the blade.
5. Look at the screen, and then complete the intubation.
6. If using a GlideRite Rigid Stylet, remove it by pulling toward the patient's feet.

Option 2. Mac-Style or Miller-Style Blade

1. If the patient's condition allows, place the head in a sniffing position.
2. Look in the mouth, insert the blade into the right side, and then sweep the tongue left.
3. Lift the blade for the best view of the larynx.
4. Look in the mouth, and then introduce an endotracheal tube alongside the blade.
5. Complete the intubation.

Procedure 3. Prepare a Component for Cleaning

1. Make sure the video monitor has been turned off.
2. Detach the video cable or scope from the monitor by doing one of the following:
 - GlideScope Video Monitor—Turn the connector ring in the direction of the release arrow, and then pull.
 - Core monitor—Hold the cable connector in one hand and support the monitor with the other, and then pull.
 - Go 2 monitor— hold the monitor in one hand and the scope's body in the other, and then pull.

If you are cleaning a video laryngoscope or baton with a detachable video cable, make sure to also detach the cable from the scope.

Figure 9. GlideScope Video Monitor



Figure 10. Core Monitor



3. Prior to cleaning or disinfecting AVL video batons, ensure that the protective cap is properly fitted on the cable connector. The arrow on the connector plug should line up with the dot on the protective cap. Video Baton 2.0, Titanium reusable video laryngoscopes, GlideScope Video Cables, GlideScope Smart Cables, Core Video Cables, and Core Smart Cables do not require a protective cap.



Correct fitting



Incorrect fitting

4. Optionally, to prevent contaminants from drying onto the surface of the device, apply a pre-cleaner to the component. Bodily contaminants tend to become securely attached to solid surfaces when dried, making removal more difficult.

Reprocessing

Some of the components in this manual may require cleaning, low-level disinfection, high-level disinfection, or sterilization between uses or under specific circumstances. For information about the cleaning, disinfection, and sterilization requirements for these components, refer to the GlideScope and GlideRite Products Reprocessing Manual, which is available at [verathon.com/service-and-support/glidescope-reprocessing-products](https://www.verathon.com/service-and-support/glidescope-reprocessing-products).

Maintenance & Safety



Please read the [Warnings & Cautions](#) section before performing the following tasks.

Periodic Inspections

No periodic inspections, maintenance, or calibrations are required by Verathon.

Report any suspected defects to Verathon Customer Care or your local representative. For contact information, visit verathon.com/service-and-support.

Elution Compatibility

For use with GlideScope Titanium reusable video laryngoscopes, Verathon has completed testing of compatibility with a 1% sodium dodecyl sulphate (SDS) solution with pH 11.0.

The SDS solution is commonly utilized in Europe as an eluting solution to collect residual protein samples from medical tools or devices that are cleaned after contacting patient tissue. The protein sample solution is then examined as a verification of the hospital cleaning process.

The testing concluded that 1% SDS solution with pH 11.0 is chemically compatible with the reusable video laryngoscopes and gives no adverse results when performing repeated 30-minute soaking for 100 cycles.

Device Repair

The system components are not user-serviceable. Verathon does not make available any type of circuit diagrams, component parts lists, descriptions, or other information that would be required for repairing the device and related accessories. All service must be performed by a qualified technician.

If you have any questions, contact your local Verathon representative or Verathon Customer Care.

Device Disposal

Disposal of this device in accordance with WEEE requirements can be coordinated through your Verathon Service Center. Alternatively, follow your local protocols for hazardous waste disposal.

Limited Warranty

ORIGINAL TOTAL CUSTOMER CARE WARRANTY

This Limited Warranty (“Warranty”) is provided by Verathon Inc. (“Verathon”) to its customer, distributor, original equipment manufacturer, end-user, or other purchaser (“Buyer”) on the terms and conditions stated herein, for the GlideScope product (“Product”). The terms of this Warranty are subject to the standard Terms and Conditions of Sale or any other separate negotiated agreement between the parties.

SCOPE OF COVERAGE: This Warranty covers service and repair of all malfunctions (mechanical, electrical, and other defects) associated with the Product purchased by Buyer from Verathon, including coverage for accidental drops or mishandling of Product (subject to Buyer’s payment of a deductible charge for Product replacement), for a period of one (1) year (unless otherwise noted under “COVERED COMPONENTS” below) from Product shipment date (“Term”), and applies only to the original Buyer. Replacement parts will be new, rebuilt or non-original manufacturer’s parts that perform to the factory specifications of the Product at Verathon’s sole option.

Verathon will perform repair and replacement services (“Service”) only on Products purchased from an authorized dealer. If the Product or component is purchased from an unauthorized dealer, or if the original factory serial number has been removed, defaced or altered, this Warranty is void.

If a Product purchased by Buyer requires Service, Verathon will, at its discretion, either repair or replace the Product and may provide a loaner unit, at Buyer’s request. If Buyer requests a loaner unit, Buyer shall send the defective Product to Verathon (cleaned and disinfected as appropriate) immediately upon receiving the loaner unit from Verathon. Buyer shall return the loaner unit within two (2) business days of receipt of the repaired Product. All exchanged parts become property of Verathon.

EXCLUSIONS: This Warranty excludes problems caused by the Buyer’s acts (or failure to act), the acts of others, or events beyond Verathon’s reasonable control including:

- Accident, theft, misuse, abuse, extraordinary wear and tear, or neglect.
- Misapplication, improper use, or other failure to follow Verathon’s product instructions and safety precautions contained in the Operations and Maintenance Manual. This warranty does not apply if there is evidence of the equipment being exposed to temperatures in excess of 60°C (140°F).
- Use of the system in conjunction with hardware, software, components, services, accessories, attachments, interfaces, or consumables, other than those supplied or specified by Verathon.
- Products that have been repaired or maintained by anyone other than a Verathon authorized service provider.
- Modification, disassembly, rewiring, re-engineering, recalibration, and/or reprogramming of Products other than as specifically authorized by Verathon in writing.

COVERED COMPONENTS: Warranty coverage applies to the following components:

- GlideScope AVL Video Batons
- GlideScope Titanium Reusable video laryngoscopes
- GlideScope Spectrum Smart Cable
- GlideScope Titanium Video Cable
- GlideScope Core Video Cable
- GlideScope Core QuickConnect Cables
- GlideScope Core Smart Cable (two-year factory warranty)
- GlideScope Video Baton 2.0 Large (two-year factory warranty)
- GlideScope Video Baton QC Large (two-year factory warranty)

Additional reusable components purchased either singularly or as a part of a system, including GlideScope Workstations and the GlideScope Video Cable, are limited to a one-year factory warranty unless stated otherwise. Consumable items are not covered under this warranty.

EXTENDED WARRANTIES: Buyer may purchase a Premium Total Customer Care warranty that extends this Limited Warranty. For more information, contact Verathon's Customer Care Department or your local representative.

LIMITED REMEDY: This Warranty gives Buyer specific legal rights which may vary based on local law. When, under applicable law, implied warranties are not allowed to be excluded in their entirety, such warranties will be limited to the duration of the applicable written warranty and, for European Customers, any terms herein limiting Verathon's liability shall not apply insofar as they conflict with mandatory statutory provisions of the Product Liability Act.

TO THE FULL EXTENT ALLOWED BY LAW, THE FOREGOING LIMITED WARRANTIES AND REMEDIES ARE EXCLUSIVE AND EXPRESSLY IN LIEU OF ALL OTHER WARRANTIES, REPRESENTATIONS, TERMS, OR CONDITIONS, WRITTEN OR ORAL, EXPRESS OR IMPLIED, STATUTORY OR OTHERWISE, INCLUDING BUT NOT LIMITED TO ANY WARRANTIES, TERMS OR CONDITIONS OF MERCHANTABILITY OR FITNESS FOR A PARTICULAR PURPOSE, SATISFACTORY QUALITY, CORRESPONDENCE WITH DESCRIPTION, AND NON-INFRINGEMENT, ALL OF WHICH ARE HEREBY EXPRESSLY DISCLAIMED.

TRANSFER OF SERVICE: This Warranty extends only to Buyer, and may not be transferred to third parties by operation of law or otherwise.

Product Specifications

Component Specifications

Reusable Video Laryngoscope Specifications

Table 9. Titanium LoPro T2 (0574-0196)

GENERAL SPECIFICATIONS		
Ingress protection:	IPX8	
Expected product life:	3 years or 3000 cycles	
ENVIRONMENTAL CONDITIONS		
	Operating Conditions	Shipping & Storage Conditions
Temperature:	10–35°C (50–95°F)	-20–45°C (-4–113°F)
Relative humidity:	10–95%	10–95%
Atmospheric pressure:	700–1060 hPa	440–1060 hPa
COMPONENT SPECIFICATIONS		
Height at handle (A)	8.5 mm	
Height at camera (B)	9.5 mm	
Blade tip to handle (C)	44.0 mm	
Width at camera (D)	13.9 mm	

Table 10. Titanium LoPro T3 (0574-0126)

GENERAL SPECIFICATIONS		
Ingress protection:	IPX8	
Expected product life:	3 years or 3000 cycles	
ENVIRONMENTAL CONDITIONS		
	Operating Conditions	Shipping & Storage Conditions
Temperature:	10–35°C (50–95°F)	-20–45°C (-4–113°F)
Relative humidity:	10–95%	10–95%
Atmospheric pressure:	700–1060 hPa	440–1060 hPa
COMPONENT SPECIFICATIONS		
Height at handle (A)	10.8 mm	
Height at camera (B)	10.5 mm	
Blade tip to handle (C)	72.0 mm	
Width at camera (D)	20.0 mm	

Table 11. Titanium LoPro T4 (0574-0127)

GENERAL SPECIFICATIONS		
Ingress protection:	IPX8	
Expected product life:	3 years or 3000 cycles	
ENVIRONMENTAL CONDITIONS		
	Operating Conditions	Shipping & Storage Conditions
Temperature:	10–35°C (50–95°F)	-20–45°C (-4–113°F)
Relative humidity:	10–95%	10–95%
Atmospheric pressure:	700–1060 hPa	440–1060 hPa
COMPONENT SPECIFICATIONS		
Height at handle (A)	11.0 mm	
Height at camera (B)	10.0 mm	
Blade tip to handle (C)	91.0 mm	
Width at camera (D)	25.0 mm	

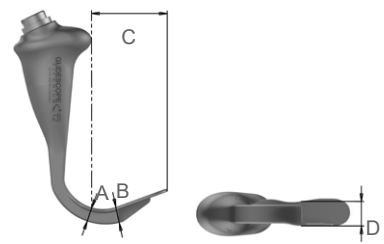
Table 12. Titanium MAC T3 (0574-0128)

GENERAL SPECIFICATIONS		
Ingress protection:	IPX8	
Expected product life:	3 years or 3000 cycles	
ENVIRONMENTAL CONDITIONS		
	Operating Conditions	Shipping & Storage Conditions
Temperature:	10–35°C (50–95°F)	-20–45°C (-4–113°F)
Relative humidity:	10–95%	10–95%
Atmospheric pressure:	700–1060 hPa	440–1060 hPa
COMPONENT SPECIFICATIONS		
Height at handle (A)	10.8 mm	
Height at camera (B)	10.5 mm	
Blade tip to handle (C)	72.0 mm	
Width at camera (D)	20.0 mm	

Table 13. Titanium MAC T4 (0574-0129)

GENERAL SPECIFICATIONS		
Ingress protection:	IPX8	
Expected product life:	3 years or 3000 cycles	
ENVIRONMENTAL CONDITIONS		
	Operating Conditions	Shipping & Storage Conditions
Temperature:	10–35°C (50–95°F)	-20–45°C (-4–113°F)
Relative humidity:	10–95%	10–95%
Atmospheric pressure:	700–1060 hPa	440–1060 hPa
COMPONENT SPECIFICATIONS		
Height at handle (A)	13.4 mm	
Height at camera (B)	9.6 mm	
Blade tip to handle (C)	128.0 mm	
Width at camera (D)	22.0 mm	

Single-use Video Laryngoscope Specifications

Table 14. Spectrum Miller S0 (Sterile 0574-0202, Non-Sterile 0574-0216)

GENERAL SPECIFICATIONS			
Ingress protection:	IPX4		
Expected product life:	Refer to the “use by” date indicated by the ⏳ symbol on the package label.		
ENVIRONMENTAL CONDITIONS			
	Operating Conditions	Shipping Conditions	Storage Conditions
Temperature:	10–40°C (50–104°F)	-20–45°C (-4–113°F)	18–28°C (64–82°F)
Relative humidity:	10–95%	10–95%	40–60%
Atmospheric pressure:	700–1060 hPa	440–1060 hPa	1013 hPa
COMPONENT SPECIFICATIONS			
Height at handle (A)	12.1 mm		
Height at camera (B)	12.2 mm		
Blade tip to handle (C)	55.5 mm		
Width at camera (D)	15.3 mm		

Table 15. Spectrum Miller S1 (Sterile 0574-0203, Non-Sterile 0574-0217)

GENERAL SPECIFICATIONS			
Ingress protection:	IPX4		
Expected product life:	Refer to the “use by” date indicated by the ⏳ symbol on the package label.		
ENVIRONMENTAL CONDITIONS			
	Operating Conditions	Shipping Conditions	Storage Conditions
Temperature:	10–40°C (50–104°F)	-20–45°C (-4–113°F)	18–28°C (64–82°F)
Relative humidity:	10–95%	10–95%	40–60%
Atmospheric pressure:	700–1060 hPa	440–1060 hPa	1013 hPa
COMPONENT SPECIFICATIONS			
Height at handle (A)	12.1 mm		
Height at camera (B)	12.2 mm		
Blade tip to handle (C)	81.5 mm		
Width at camera (D)	15.3 mm		

Table 16. Spectrum LoPro S1 (Sterile 0574-0165, Non-Sterile 0574-0218)

GENERAL SPECIFICATIONS			
Ingress protection:	IPX4		
Expected product life:	Refer to the “use by” date indicated by the ⏰ symbol on the package label.		
ENVIRONMENTAL CONDITIONS			
	Operating Conditions	Shipping Conditions	Storage Conditions
Temperature:	10–40°C (50–104°F)	-20–45°C (-4–113°F)	18–28°C (64–82°F)
Relative humidity:	10–95%	10–95%	40–60%
Atmospheric pressure:	700–1060 hPa	440–1060 hPa	1013 hPa
COMPONENT SPECIFICATIONS			
Height at handle (A)	8.7 mm		
Height at camera (B)	9.6 mm		
Blade tip to handle (C)	29.0 mm		
Width at camera (D)	12.2 mm		

Table 17. Spectrum LoPro S2 (Sterile 0574-0166, Non-Sterile 0574-0219)

GENERAL SPECIFICATIONS			
Ingress protection:	IPX4		
Expected product life:	Refer to the “use by” date indicated by the ⏰ symbol on the package label.		
ENVIRONMENTAL CONDITIONS			
	Operating Conditions	Shipping Conditions	Storage Conditions
Temperature:	10–40°C (50–104°F)	-20–45°C (-4–113°F)	18–28°C (64–82°F)
Relative humidity:	10–95%	10–95%	40–60%
Atmospheric pressure:	700–1060 hPa	440–1060 hPa	1013 hPa
COMPONENT SPECIFICATIONS			
Height at handle (A)	8.7 mm		
Height at camera (B)	9.6 mm		
Blade tip to handle (C)	44.0 mm		
Width at camera (D)	13.0 mm		

Table 18. Spectrum LoPro S2.5 (Sterile 0574-0201, Non-Sterile 0574-0220)

GENERAL SPECIFICATIONS			
Ingress protection:	IPX4		
Expected product life:	Refer to the “use by” date indicated by the  symbol on the package label.		
ENVIRONMENTAL CONDITIONS			
	Operating Conditions	Shipping Conditions	Storage Conditions
Temperature:	10–40°C (50–104°F)	-20–45°C (-4–113°F)	18–28°C (64–82°F)
Relative humidity:	10–95%	10–95%	40–60%
Atmospheric pressure:	700–1060 hPa	440–1060 hPa	1013 hPa
COMPONENT SPECIFICATIONS			
Height at handle (A)	10.3 mm		
Height at camera (B)	9.6 mm		
Blade tip to handle (C)	57.0 mm		
Width at camera (D)	16.0 mm		

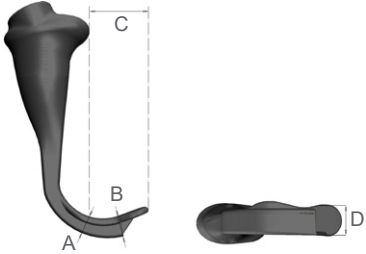
Table 19. Spectrum LoPro S3 (Sterile 0574-0194, Non-Sterile 0574-0221)

GENERAL SPECIFICATIONS			
Ingress protection:	IPX4		
Expected product life:	Refer to the “use by” date indicated by the  symbol on the package label.		
ENVIRONMENTAL CONDITIONS			
	Operating Conditions	Shipping Conditions	Storage Conditions
Temperature:	10–40°C (50–104°F)	-20–45°C (-4–113°F)	18–28°C (64–82°F)
Relative humidity:	10–95%	10–95%	40–60%
Atmospheric pressure:	700–1060 hPa	440–1060 hPa	1013 hPa
COMPONENT SPECIFICATIONS			
Height at handle (A)	11.0 mm		
Height at camera (B)	11.0 mm		
Blade tip to handle (C)	74.0 mm		
Width at camera (D)	20.0 mm		

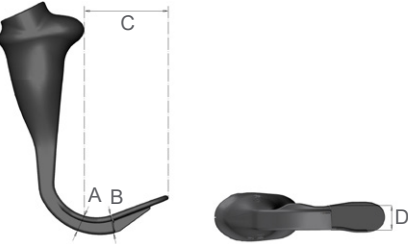
Table 20. Spectrum LoPro S4 (Sterile 0574-0195, Non-Sterile 0574-0222)

GENERAL SPECIFICATIONS			
Ingress protection:	IPX4		
Expected product life:	Refer to the “use by” date indicated by the ⏰ symbol on the package label.		
ENVIRONMENTAL CONDITIONS			
	Operating Conditions	Shipping Conditions	Storage Conditions
Temperature:	10–40°C (50–104°F)	-20–45°C (-4–113°F)	18–28°C (64–82°F)
Relative humidity:	10–95%	10–95%	40–60%
Atmospheric pressure:	700–1060 hPa	440–1060 hPa	1013 hPa
COMPONENT SPECIFICATIONS			
Height at handle (A)	12.0 mm		
Height at camera (B)	11.3 mm		
Blade tip to handle (C)	91.0 mm		
Width at camera (D)	25.0 mm		

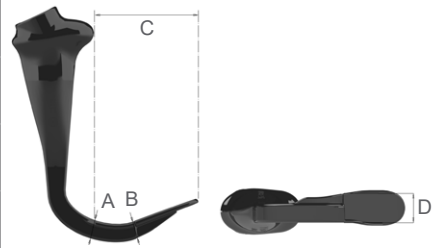
Table 21. Spectrum MAC S3 (Sterile 0574-0187, Non-Sterile 0574-0223)

GENERAL SPECIFICATIONS			
Ingress protection:	IPX4		
Expected product life:	Refer to the “use by” date indicated by the ⏰ symbol on the package label.		
ENVIRONMENTAL CONDITIONS			
	Operating Conditions	Shipping Conditions	Storage Conditions
Temperature:	10–40°C (50–104°F)	-20–45°C (-4–113°F)	18–28°C (64–82°F)
Relative humidity:	10–95%	10–95%	40–60%
Atmospheric pressure:	700–1060 hPa	440–1060 hPa	1013 hPa
COMPONENT SPECIFICATIONS			
Height at handle (A)	14.6 mm		
Height at camera (B)	11.7 mm		
Blade tip to handle (C)	107.5 mm		
Width at camera (D)	26.6 mm		

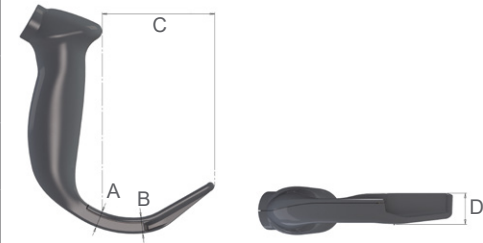
Table 22. Spectrum MAC S4 (Sterile 0574-0188, Non-Sterile 0574-0224)

GENERAL SPECIFICATIONS			
Ingress protection:	IPX4		
Expected product life:	Refer to the “use by” date indicated by the ⏰ symbol on the package label.		
ENVIRONMENTAL CONDITIONS			
	Operating Conditions	Shipping Conditions	Storage Conditions
Temperature:	10–40°C (50–104°F)	-20–45°C (-4–113°F)	18–28°C (64–82°F)
Relative humidity:	10–95%	10–95%	40–60%
Atmospheric pressure:	700–1060 hPa	440–1060 hPa	1013 hPa
COMPONENT SPECIFICATIONS			
Height at handle (A)	14.3 mm		
Height at camera (B)	11.4 mm		
Blade tip to handle (C)	128.0 mm		
Width at camera (D)	26.4 mm		

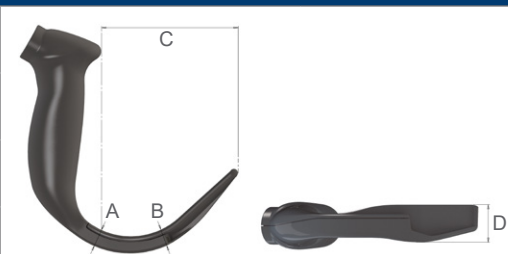
Table 23. Spectrum QC Hyperangle S1 (Sterile 0574-0232, Non-Sterile 0574-0264)

GENERAL SPECIFICATIONS				
Ingress protection:	IP34: Protected against solid foreign objects of 2.5 mm and greater. Protected against water splashing the enclosure from any direction.			
Expected product life:	Refer to the “use by” date indicated by the ⏰ symbol on the package label.			
ENVIRONMENTAL CONDITIONS				
	Operating Conditions	Shipping Conditions	Transient Operating Conditions	Storage Conditions
Temperature:	0–40°C (32–104°F)	-20–45°C (-4–113°F)	-20–50°C (-4–122°F)	18–28°C (64–82°F)
Relative humidity:	10–95%	10–95%	15–90%	40–60%
Atmospheric pressure:	700–1060 hPa	540–1060 hPa	—	1013 hPa
COMPONENT SPECIFICATIONS				
Height at handle (A)	8.7 mm			
Height at camera (B)	9.6 mm			
Blade tip to handle (C)	29.0 mm			
Width at camera (D)	12.2 mm			

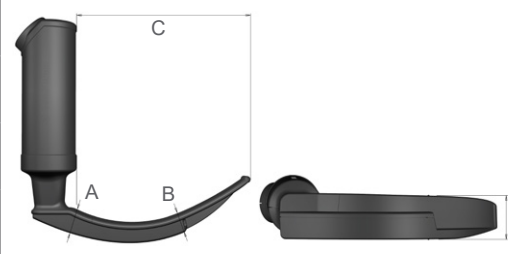
Table 24. Spectrum QC Hyperangle S2 (Sterile 0574-0233, Non-Sterile 0574-0265)

GENERAL SPECIFICATIONS				
Ingress protection:	IP34: Protected against solid foreign objects of 2.5 mm and greater. Protected against water splashing the enclosure from any direction.			
Expected product life:	Refer to the “use by” date indicated by the ⏳ symbol on the package label.			
ENVIRONMENTAL CONDITIONS				
	Operating Conditions	Shipping Conditions	Transient Operating Conditions	Storage Conditions
Temperature:	0–40°C (32–104°F)	-20–45°C (-4–113°F)	-20–50°C (-4–122°F)	18–28°C (64–82°F)
Relative humidity:	10–95%	10–95%	15–90%	40–60%
Atmospheric pressure:	700–1060 hPa	540–1060 hPa	—	1013 hPa
COMPONENT SPECIFICATIONS				
Height at handle (A)	8.7 mm			
Height at camera (B)	9.6 mm			
Blade tip to handle (C)	44.0 mm			
Width at camera (D)	13.0 mm			

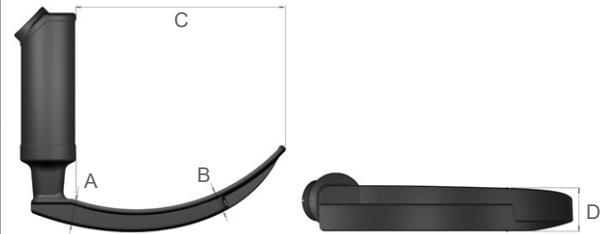
Table 25. Spectrum QC Hyperangle S2.5 (Sterile 0574-0234, Non-Sterile 0574-0266)

GENERAL SPECIFICATIONS				
Ingress protection:	IP34: Protected against solid foreign objects of 2.5 mm and greater. Protected against water splashing the enclosure from any direction.			
Expected product life:	Refer to the “use by” date indicated by the ⏳ symbol on the package label.			
ENVIRONMENTAL CONDITIONS				
	Operating Conditions	Shipping Conditions	Transient Operating Conditions	Storage Conditions
Temperature:	0–40°C (32–104°F)	-20–45°C (-4–113°F)	-20–50°C (-4–122°F)	18–28°C (64–82°F)
Relative humidity:	10–95%	10–95%	15–90%	40–60%
Atmospheric pressure:	700–1060 hPa	540–1060 hPa	—	1013 hPa
COMPONENT SPECIFICATIONS				
Height at handle (A)	10.3 mm			
Height at camera (B)	9.6 mm			
Blade tip to handle (C)	57.0 mm			
Width at camera (D)	16.0 mm			

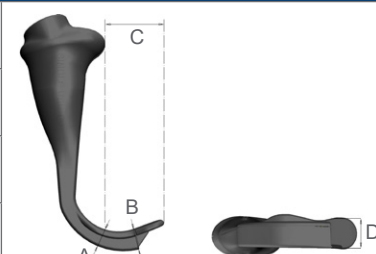
Table 26. Spectrum QC Hyperangle S3 (Sterile 0574-0225, Non-Sterile 0574-0267)

GENERAL SPECIFICATIONS				
Ingress protection:	IP34: Protected against solid foreign objects of 2.5 mm and greater. Protected against water splashing the enclosure from any direction.			
Expected product life:	Refer to the “use by” date indicated by the  symbol on the package label.			
ENVIRONMENTAL CONDITIONS				
	Operating Conditions	Shipping Conditions	Transient Operating Conditions	Storage Conditions
Temperature:	0–40°C (32–104°F)	-20–45°C (-4–113°F)	-20–50°C (-4–122°F)	18–28°C (64–82°F)
Relative humidity:	10–95%	10–95%	15–90%	40–60%
Atmospheric pressure:	700–1060 hPa	540–1060 hPa	—	1013 hPa
COMPONENT SPECIFICATIONS				
Height at handle (A)	11.0 mm			
Height at camera (B)	11.0 mm			
Blade tip to handle (C)	74.0 mm			
Width at camera (D)	20.0 mm			

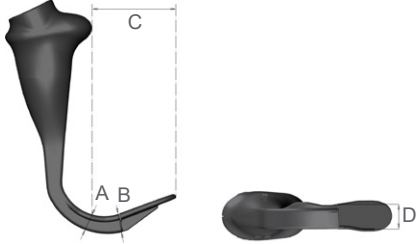
Table 27. Spectrum QC Hyperangle S4 (Sterile 0574-0226, Non-Sterile 0574-0268)

GENERAL SPECIFICATIONS				
Ingress protection:	IP34: Protected against solid foreign objects of 2.5 mm and greater. Protected against water splashing the enclosure from any direction.			
Expected product life:	Refer to the “use by” date indicated by the  symbol on the package label.			
ENVIRONMENTAL CONDITIONS				
	Operating Conditions	Shipping Conditions	Transient Operating Conditions	Storage Conditions
Temperature:	0–40°C (32–104°F)	-20–45°C (-4–113°F)	-20–50°C (-4–122°F)	18–28°C (64–82°F)
Relative humidity:	10–95%	10–95%	15–90%	40–60%
Atmospheric pressure:	700–1060 hPa	540–1060 hPa	—	1013 hPa
COMPONENT SPECIFICATIONS				
Height at handle (A)	12.0 mm			
Height at camera (B)	11.3 mm			
Blade tip to handle (C)	91.0 mm			
Width at camera (D)	25.0 mm			

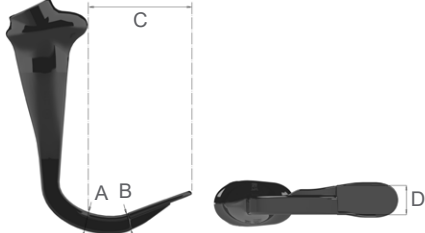
Table 28. Spectrum QC Miller S00 (Non-Sterile 0574-0275)

GENERAL SPECIFICATIONS				
Ingress protection:	IP34: Protected against solid foreign objects of 2.5 mm and greater. Protected against water splashing the enclosure from any direction.			
Expected product life:	Refer to the “use by” date indicated by the ☞ symbol on the package label.			
ENVIRONMENTAL CONDITIONS				
	Operating Conditions	Shipping Conditions	Transient Operating Conditions	Storage Conditions
Temperature:	0–40°C (50–104°F)	-20–45°C (-4–113°F)	-20–50°C (-4–122°F)	18–28°C (64–82°F)
Relative humidity:	10–95%	10–95%	15–90%	40–60%
Atmospheric pressure:	700–1060 hPa	540–1060 hPa	—	1013 hPa
COMPONENT SPECIFICATIONS				
Height at handle (A)	10.5 mm			
Height at camera (B)	10.6 mm			
Blade tip to handle (C)	38.8 mm			
Width at camera (D)	12.5 mm			
Field of view (diagonal)	71.9°			
Direction of view	8°			
Insertion portion width	18.00 mm			

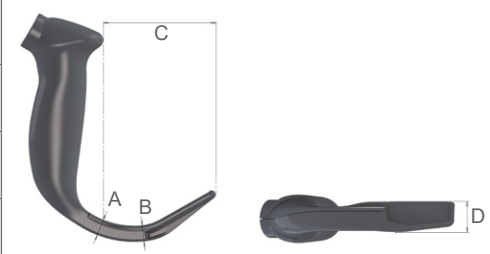
Table 29. Spectrum QC Miller S0 (Sterile 0574-0230, Non-Sterile 0574-0271)

GENERAL SPECIFICATIONS				
Ingress protection:	IP34: Protected against solid foreign objects of 2.5 mm and greater. Protected against water splashing the enclosure from any direction.			
Expected product life:	Refer to the “use by” date indicated by the ☞ symbol on the package label.			
ENVIRONMENTAL CONDITIONS				
	Operating Conditions	Shipping Conditions	Transient Operating Conditions	Storage Conditions
Temperature:	0–40°C (32–104°F)	-20–45°C (-4–113°F)	-20–50°C (-4–122°F)	18–28°C (64–82°F)
Relative humidity:	10–95%	10–95%	15–90%	40–60%
Atmospheric pressure:	700–1060 hPa	540–1060 hPa	—	1013 hPa
COMPONENT SPECIFICATIONS				
Height at handle (A)	12.1 mm			
Height at camera (B)	12.2 mm			
Blade tip to handle (C)	55.5 mm			
Width at camera (D)	15.3 mm			

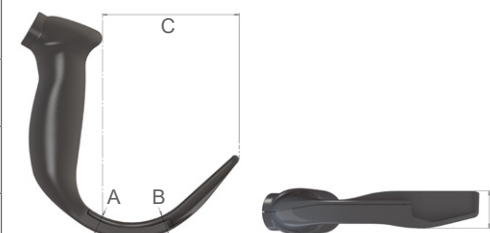
Table 30. Spectrum QC Miller S1 (Sterile 0574-0231, Non-Sterile 0574-0272)

GENERAL SPECIFICATIONS				
Ingress protection:	IP34: Protected against solid foreign objects of 2.5 mm and greater. Protected against water splashing the enclosure from any direction.			
Expected product life:	Refer to the “use by” date indicated by the  symbol on the package label.			
ENVIRONMENTAL CONDITIONS				
	Operating Conditions	Shipping Conditions	Transient Operating Conditions	Storage Conditions
Temperature:	0–40°C (32–104°F)	-20–45°C (-4–113°F)	-20–50°C (-4–122°F)	18–28°C (64–82°F)
Relative humidity:	10–95%	10–95%	15–90%	40–60%
Atmospheric pressure:	700–1060 hPa	540–1060 hPa	—	1013 hPa
COMPONENT SPECIFICATIONS				
Height at handle (A)	12.1 mm			
Height at camera (B)	12.2 mm			
Blade tip to handle (C)	81.5 mm			
Width at camera (D)	15.3 mm			

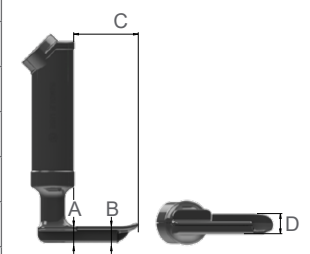
Table 31. Spectrum QC Miller S2 (Non-Sterile 0574-0267)

GENERAL SPECIFICATIONS				
Ingress protection:	IP34: Protected against solid foreign objects of 2.5 mm and greater. Protected against water splashing the enclosure from any direction.			
Expected product life:	Refer to the “use by” date indicated by the  symbol on the package label.			
ENVIRONMENTAL CONDITIONS				
	Operating Conditions	Shipping Conditions	Transient Operating Conditions	Storage Conditions
Temperature:	0–40°C (50–104°F)	-20–45°C (-4–113°F)	-20–50°C (-4–122°F)	18–28°C (64–82°F)
Relative humidity:	10–95%	10–95%	15–90%	40–60%
Atmospheric pressure:	700–1060 hPa	540–1060 hPa	—	1013 hPa
COMPONENT SPECIFICATIONS				
Height at handle (A)	13.8 mm			
Height at camera (B)	13.9 mm			
Blade tip to handle (C)	129.5 mm			
Width at camera (D)	16.2 mm			
Field of view (diagonal)	71.9°			
Direction of view	11°			
Insertion portion width	24.00 mm			

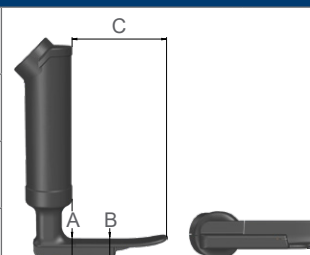
Table 32. Spectrum QC MAC S1 (Non-Sterile 0574-0274)

GENERAL SPECIFICATIONS				
Ingress protection:	IP34: Protected against solid foreign objects of 2.5 mm and greater. Protected against water splashing the enclosure from any direction.			
Expected product life:	Refer to the “use by” date indicated by the  symbol on the package label.			
ENVIRONMENTAL CONDITIONS				
	Operating Conditions	Shipping Conditions	Transient Operating Conditions	Storage Conditions
Temperature:	0–40°C (50–104°F)	-20–45°C (-4–113°F)	-20–50°C (-4–122°F)	18–28°C (64–82°F)
Relative humidity:	10–95%	10–95%	15–90%	40–60%
Atmospheric pressure:	700–1060 hPa	540–1060 hPa	—	1013 hPa
COMPONENT SPECIFICATIONS				
Height at handle (A)	15.6 mm			
Height at camera (B)	11.9 mm			
Blade tip to handle (C)	73.3 mm			
Width at camera (D)	14.6 mm			
Field of view (diagonal)	71.9°			
Direction of view	12°			
Insertion portion width	26.00 mm			

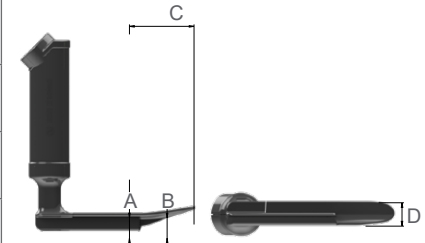
Table 33. Spectrum QC MAC S2 (Non-Sterile 0574-0273)

GENERAL SPECIFICATIONS				
Ingress protection:	IP34: Protected against solid foreign objects of 2.5 mm and greater. Protected against water splashing the enclosure from any direction.			
Expected product life:	Refer to the “use by” date indicated by the  symbol on the package label.			
ENVIRONMENTAL CONDITIONS				
	Operating Conditions	Shipping Conditions	Transient Operating Conditions	Storage Conditions
Temperature:	0–40°C (50–104°F)	-20–45°C (-4–113°F)	-20–50°C (-4–122°F)	18–28°C (64–82°F)
Relative humidity:	10–95%	10–95%	15–90%	40–60%
Atmospheric pressure:	700–1060 hPa	540–1060 hPa	—	1013 hPa
COMPONENT SPECIFICATIONS				
Height at handle (A)	15.1 mm			
Height at camera (B)	10.4 mm			
Blade tip to handle (C)	88.3 mm			
Width at camera (D)	22.8 mm			
Field of view (diagonal)	71.9°			
Direction of view	12°			
Insertion portion width	33.00 mm			

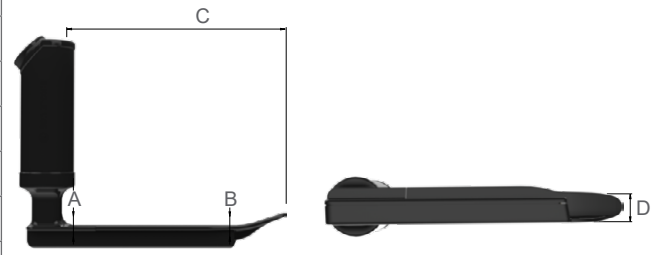
Table 34. Spectrum QC MAC S3 (Sterile 0574-0227, Non-Sterile 0574-0269)

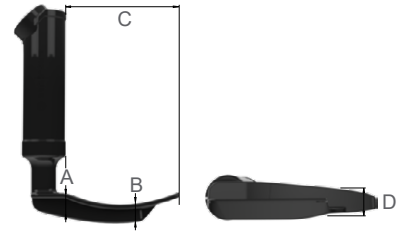

GENERAL SPECIFICATIONS				
Ingress protection:	IP34: Protected against solid foreign objects of 2.5 mm and greater. Protected against water splashing the enclosure from any direction.			
Expected product life:	Refer to the “use by” date indicated by the  symbol on the package label.			
ENVIRONMENTAL CONDITIONS				
	Operating Conditions	Shipping Conditions	Transient Operating Conditions	Storage Conditions
Temperature:	0–40°C (32–104°F)	-20–45°C (-4–113°F)	-20–50°C (-4–122°F)	18–28°C (64–82°F)
Relative humidity:	10–95%	10–95%	15–90%	40–60%
Atmospheric pressure:	700–1060 hPa	540–1060 hPa	—	1013 hPa
COMPONENT SPECIFICATIONS				
Height at handle (A)	14.6 mm			
Height at camera (B)	11.7 mm			
Blade tip to handle (C)	107.5 mm			
Width at camera (D)	26.6 mm			

Table 35. Spectrum QC MAC S4 (Sterile 0574-0228, Non-Sterile 0574-0270)

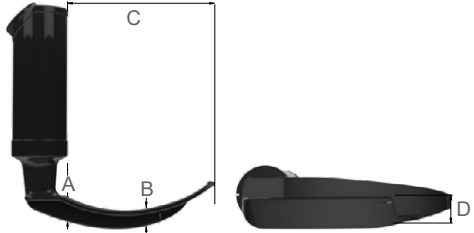
GENERAL SPECIFICATIONS				
Ingress protection:	IP34: Protected against solid foreign objects of 2.5 mm and greater. Protected against water splashing the enclosure from any direction.			
Expected product life:	Refer to the “use by” date indicated by the  symbol on the package label.			
ENVIRONMENTAL CONDITIONS				
	Operating Conditions	Shipping Conditions	Transient Operating Conditions	Storage Conditions
Temperature:	0–40°C (32–104°F)	-20–45°C (-4–113°F)	-20–50°C (-4–122°F)	18–28°C (64–82°F)
Relative humidity:	10–95%	10–95%	15–90%	40–60%
Atmospheric pressure:	700–1060 hPa	540–1060 hPa	—	1013 hPa
COMPONENT SPECIFICATIONS				
Height at handle (A)	14.3 mm			
Height at camera (B)	11.4 mm			
Blade tip to handle (C)	128.0 mm			
Width at camera (D)	26.4 mm			

Video Baton Specifications

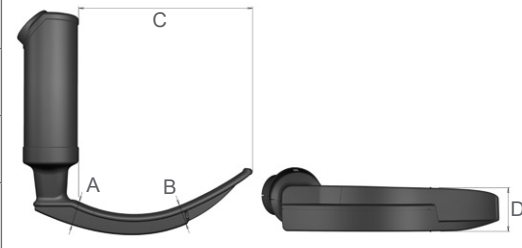
Table 36. Video Baton 1-2 (0570-0306)

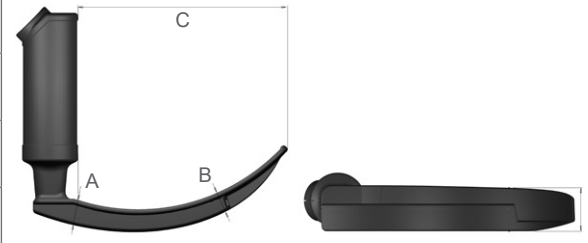
GENERAL SPECIFICATIONS		
Ingress protection:	IPX8	
Expected product life:	2 years or 1000 cycles	
ENVIRONMENTAL CONDITIONS		
	Operating Conditions	Shipping & Storage Conditions
Temperature:	10–40°C (50–104°F)	-20–45°C (-4–113°F)
Relative humidity:	10–95%	10–95%
Atmospheric pressure:	700–1060 hPa	440–1060 hPa
COMPONENT SPECIFICATIONS		
Length of flexible portion of baton (A)	66.0 mm	 <p>Cable shortened for illustrative purposes</p>
Height at camera (B)	6.0 mm	
Width at camera (C)	7.0 mm	
Video cable length (D)	2041 ± 50 mm	
Field of view (E)	41°	
Direction of view	0°	

Table 37. Video Baton 3-4 (0570-0307)

GENERAL SPECIFICATIONS		
Ingress protection:	IPX8	
Expected product life:	2 years or 1000 cycles	
ENVIRONMENTAL CONDITIONS		
	Operating Conditions	Shipping & Storage Conditions
Temperature:	10–40°C (50–104°F)	-20–45°C (-4–113°F)
Relative humidity:	10–95%	10–95%
Atmospheric pressure:	700–1060 hPa	440–1060 hPa
COMPONENT SPECIFICATIONS		
Length of flexible portion of baton (A)	105.0 mm	 <p>Cable shortened for illustrative purposes</p>
Height at camera (B)	11 mm	
Width at camera (C)	11 mm	
Video cable length (D)	1540 ± 50 mm	
Field of view (E)	49°	
Direction of view	0°	

Table 38. Video Baton 2.0 Large (3-4; 0570-0382)

GENERAL SPECIFICATIONS		
Ingress protection:	IPX8	
Expected product life:	2 years or 2000 cycles	
ENVIRONMENTAL CONDITIONS		
	Operating Conditions	Shipping & Storage Conditions
Temperature:	10–40°C (50–104°F)	-20–45°C (-4–113°F)
Relative humidity:	10–95%	10–95%
Atmospheric pressure:	700–1060 hPa	440–1060 hPa
COMPONENT SPECIFICATIONS		
Length of flexible portion of baton (A)	105.0 mm	
Height at camera (B)	11 mm	
Width at camera (C)	11 mm	
Field of view (E)	49°	
Direction of view	0°	

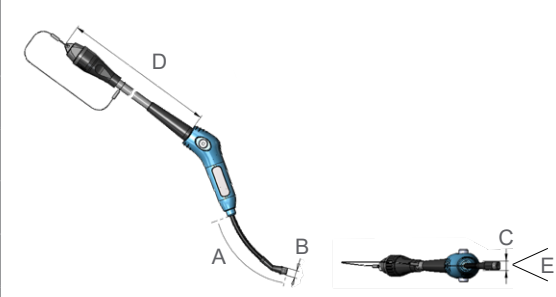
Table 39. Video Baton QC Large (0570-0417)

GENERAL SPECIFICATIONS		
Ingress protection:	IPX8	
Expected product life:	2 years or 2000 cycles	
ENVIRONMENTAL CONDITIONS		
	Operating Conditions	Shipping & Storage Conditions
Temperature:	10–35°C (50–95°F)	-20–45°C (-4–113°F)
Relative humidity:	10–95%	10–95%
Atmospheric pressure:	700–1060 hPa	440–1060 hPa
COMPONENT SPECIFICATIONS		
Length of flexible portion of baton (A)	105.0 mm	
Height at camera (B)	11 mm	
Width at camera (C)	11 mm	
Field of view (E)	49°	
Direction of view	0°	

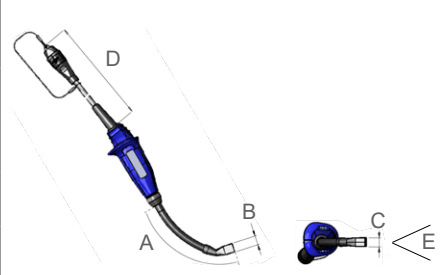
GVL Stat Specifications

Table 40. GVL Stat 0 (Sterile 0574-0104, Non-Sterile 0574-0236)

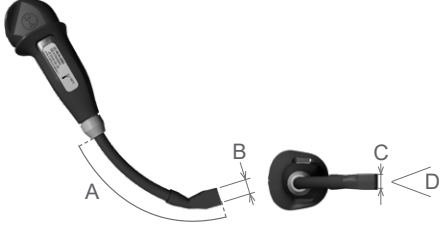
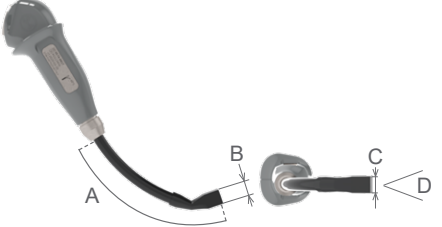
GENERAL SPECIFICATIONS			
Expected product life:	Refer to the “use by” date indicated by the ☞ symbol on the package label.		
ENVIRONMENTAL CONDITIONS			
	Operating Conditions	Shipping Conditions	Storage Conditions
Temperature:	10–40°C (50–104°F)	0–45°C (32–113°F)	18–28°C (64–82°F)
Relative humidity:	10–95%	10–95%	40–60%
Atmospheric pressure:	700–1060 hPa	800–1060 hPa	1013 hPa
COMPONENT SPECIFICATIONS			
Height at camera (A)	8.6 mm		
Blade tip to handle (B)	36.2 mm		
Width at camera (C)	11.0 mm		
Blade length in front of camera (D)	6.5 mm		
Max blade width in front of camera (E)	11.0 mm		

Table 41. GVL Stat 1 (Sterile 0574-0026, Non-Sterile 0574-0237)

GENERAL SPECIFICATIONS			
Expected product life:	Refer to the “use by” date indicated by the ☞ symbol on the package label.		
ENVIRONMENTAL CONDITIONS			
	Operating Conditions	Shipping Conditions	Storage Conditions
Temperature:	10–40°C (50–104°F)	0–45°C (32–113°F)	18–28°C (64–82°F)
Relative humidity:	10–95%	10–95%	40–60%
Atmospheric pressure:	700–1060 hPa	800–1060 hPa	1013 hPa
COMPONENT SPECIFICATIONS			
Height at camera (A)	8.6 mm		
Blade tip to handle (B)	43.5 mm		
Width at camera (C)	10.1 mm		
Blade length in front of camera (D)	15.0 mm		
Max blade width in front of camera (E)	12.7 mm		

Table 42. GVL Stat 2 (Sterile 0574-0027, Non-Sterile 0574-0238)

GENERAL SPECIFICATIONS			
Expected product life:	Refer to the “use by” date indicated by the  symbol on the package label.		
ENVIRONMENTAL CONDITIONS			
	Operating Conditions	Shipping Conditions	Storage Conditions
Temperature:	10–40°C (50–104°F)	0–45°C (32–113°F)	18–28°C (64–82°F)
Relative humidity:	10–95%	10–95%	40–60%
Atmospheric pressure:	700–1060 hPa	800–1060 hPa	1013 hPa
COMPONENT SPECIFICATIONS			
Height at camera (A)	8.6 mm		
Blade tip to handle (B)	55.7 mm		
Width at camera (C)	11.2 mm		
Blade length in front of camera (D)	28.0 mm		
Max blade width in front of camera (E)	16.0 mm		

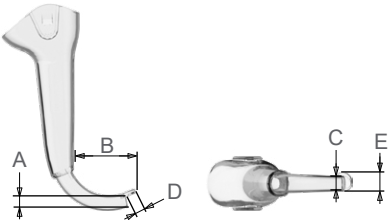
Table 43. GVL Stat 2.5 (Sterile 0574-0110, Non-Sterile 0574-0239)

GENERAL SPECIFICATIONS			
Expected product life:	Refer to the “use by” date indicated by the  symbol on the package label.		
ENVIRONMENTAL CONDITIONS			
	Operating Conditions	Shipping Conditions	Storage Conditions
Temperature:	10–40°C (50–104°F)	0–45°C (32–113°F)	18–28°C (64–82°F)
Relative humidity:	10–95%	10–95%	40–60%
Atmospheric pressure:	700–1060 hPa	800–1060 hPa	1013 hPa
COMPONENT SPECIFICATIONS			
Height at camera (A)	9.1 mm		
Blade tip to handle (B)	63.4 mm		
Width at camera (C)	12.7 mm		
Blade length in front of camera (D)	37.0 mm		
Max blade width in front of camera (E)	19.7 mm		

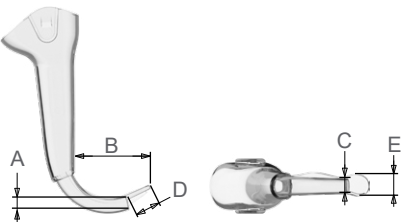
Table 44. GVL Stat 3 (Sterile 0574-0100, Non-Sterile 0574-0240)

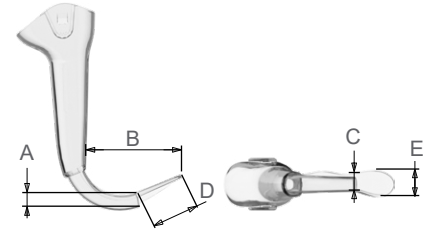

GENERAL SPECIFICATIONS			
Expected product life:	Refer to the “use by” date indicated by the  symbol on the package label.		
ENVIRONMENTAL CONDITIONS			
	Operating Conditions	Shipping Conditions	Storage Conditions
Temperature:	10–40°C (50–104°F)	-20–45°C (-4–113°F)	18–28°C (64–82°F)
Relative humidity:	10–95%	10–95%	40–60%
Atmospheric pressure:	700–1060 hPa	800–1060 hPa	1013 hPa
COMPONENT SPECIFICATIONS			
Height at camera (A)	14.3 mm		
Blade tip to handle (B)	77.8 mm		
Width at camera (C)	16.0 mm		
Blade length in front of camera (D)	37.0 mm		
Max blade width in front of camera (E)	19.7 mm		

Table 45. GVL Stat 4 (Sterile 0574-0101, Non-Sterile 0574-0241)

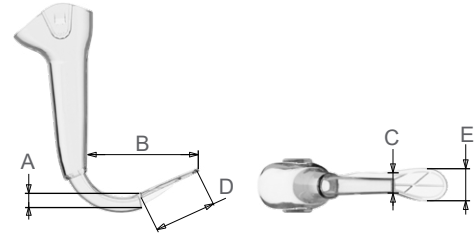
GENERAL SPECIFICATIONS			
Expected product life:	Refer to the “use by” date indicated by the  symbol on the package label.		
ENVIRONMENTAL CONDITIONS			
	Operating Conditions	Shipping Conditions	Storage Conditions
Temperature:	10–40°C (50–104°F)	-20–45°C (-4–113°F)	18–28°C (64–82°F)
Relative humidity:	10–95%	10–95%	40–60%
Atmospheric pressure:	700–1060 hPa	800–1060 hPa	1013 hPa
COMPONENT SPECIFICATIONS			
Height at camera (A)	14.3 mm		
Blade tip to handle (B)	92.4 mm		
Width at camera (C)	20.3 mm		
Blade length in front of camera (D)	52.0 mm		
Max blade width in front of camera (E)	27.5 mm		

Cable Specifications

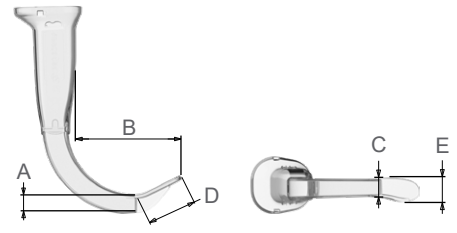
Table 46. Core Smart Cable (0600-0783)

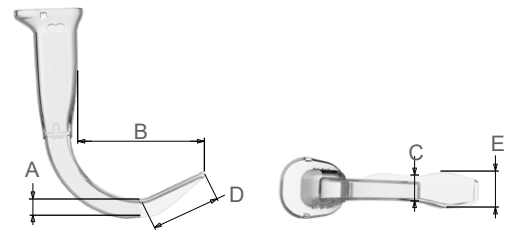
GENERAL SPECIFICATIONS	
Ingress protection:	IPX7
ENVIRONMENTAL CONDITIONS	
Qualified for use under the conditions of accompanying system components. For more information, see the other component specifications in this chapter, or your monitor's operations and maintenance manual.	
COMPONENT SPECIFICATIONS	
Length (A)	1425 ± 25 mm
Diameter (B)	6.8 mm



The diagram shows two parallel cables. A horizontal line labeled 'A' spans the length of the top cable. A vertical double-headed arrow labeled 'B' indicates the diameter of the top cable.

Table 47. Core Video Cable (0600-0771)

GENERAL SPECIFICATIONS	
Ingress protection:	IPX7
ENVIRONMENTAL CONDITIONS	
Qualified for use under the conditions of accompanying system components. For more information, see the other component specifications in this chapter, or your monitor's operations and maintenance manual.	
COMPONENT SPECIFICATIONS	
Length (A)	1524 ± 25 mm
Diameter (B)	6.8 mm



The diagram shows two parallel cables. A horizontal line labeled 'A' spans the length of the top cable. A vertical double-headed arrow labeled 'B' indicates the diameter of the top cable.

Table 48. Core QuickConnect Cable (0600-0767)

GENERAL SPECIFICATIONS	
Ingress protection:	IPX7
ENVIRONMENTAL CONDITIONS	
Qualified for use under the conditions of accompanying system components. For more information, see the other component specifications in this chapter, or your monitor's operations and maintenance manual.	
COMPONENT SPECIFICATIONS	
Length (A)	1524 ± 50 mm
Diameter (B)	6.8 mm



The diagram shows two parallel cables. A horizontal line labeled 'A' spans the length of the top cable. A vertical double-headed arrow labeled 'B' indicates the diameter of the top cable.

Table 49. Core 2m QuickConnect Cable (0600-0843)

GENERAL SPECIFICATIONS	
Ingress protection:	IPX7
ENVIRONMENTAL CONDITIONS	
Qualified for use under the conditions of accompanying system components. For more information, see the other component specifications in this chapter, or your monitor's operations and maintenance manual.	
COMPONENT SPECIFICATIONS	
Length (A)	1981 ± 50 mm
Diameter (B)	6.8 mm

The diagram shows two parallel cables. A horizontal line labeled 'A' spans the length of the top cable. A vertical double-headed arrow labeled 'B' indicates the diameter of the cable.

Table 50. Spectrum Smart Cable (0800-0543)

GENERAL SPECIFICATIONS	
Ingress protection:	IPX7
ENVIRONMENTAL CONDITIONS	
Qualified for use under the conditions of accompanying system components. For more information, see the other component specifications in this chapter, or your monitor's operations and maintenance manual.	
COMPONENT SPECIFICATIONS	
Length (A)	1417 ± 25 mm
Diameter (B)	6.8 mm

The diagram shows two parallel cables. A horizontal line labeled 'A' spans the length of the top cable. A vertical double-headed arrow labeled 'B' indicates the diameter of the cable.

Table 51. Titanium Video Cable (0600-0616)

GENERAL SPECIFICATIONS	
Ingress protection:	IPX8
ENVIRONMENTAL CONDITIONS	
Qualified for use under the conditions of accompanying system components. For more information, see the other component specifications in this chapter, or your monitor's operations and maintenance manual.	
COMPONENT SPECIFICATIONS	
Length (A)	2060 ± 25 mm
Diameter (B)	5.4 mm

The diagram shows two parallel cables. A horizontal line labeled 'A' spans the length of the top cable. A vertical double-headed arrow labeled 'B' indicates the diameter of the cable.

Electromagnetic Compatibility

The system is designed to be in compliance with IEC 60601-1-2, which contains electromagnetic compatibility (EMC) requirements for medical electrical equipment. The limits for emissions and immunity specified in this standard are designed to provide reasonable protection against harmful interference in a typical medical installation.

The system complies with the applicable essential performance requirements specified in IEC 60601-1, IEC 60601-1-12 (Go 2 EMS approved devices only), and IEC 60601-2-18. Results of immunity testing show that the essential performance of the system is not affected under the test conditions described in the following tables. For more information about the essential performance of the system, see [Essential Performance](#) on page 1.

Electromagnetic Emissions

Table 52. Guidance and Manufacturer's Declaration—Electromagnetic Emissions

The system is intended for use in the electromagnetic environment specified below. The customer or the user of the system should ensure that it is used in such an environment.

EMISSIONS TEST	COMPLIANCE	ELECTROMAGNETIC ENVIRONMENT – GUIDANCE
RF emissions CISPR 11	Group 1	The system uses RF energy only for its internal function. Therefore, its RF emissions are very low and are not likely to cause any interference in nearby electronic equipment.
RF emissions CISPR 11	Class A	The system is suitable for use in all establishments other than domestic and those directly connected to the public low-voltage power supply network that supplies buildings used for domestic purposes.
Harmonic emissions IEC 61000-3-2	Class A	
Voltage fluctuations/ flicker emissions IEC 61000-3-3	In compliance	

Electromagnetic Immunity

Table 53. Guidance and Manufacturer’s Declaration—Electromagnetic Immunity

The system is intended for use in the electromagnetic environment specified below. The customer or the user of the system should ensure that it is used in such an environment.

IMMUNITY TESTS	IEC 60601 TEST LEVEL	COMPLIANCE LEVEL	ELECTROMAGNETIC ENVIRONMENT – GUIDANCE
Electrostatic discharge (ESD) IEC 61000-4-2	± 8 kV contact ± 15 kV air	In compliance	Floors should be wood, concrete, or ceramic tile. If floors are covered with synthetic material, the relative humidity should be at least 30%.
Electrical fast transient/burst IEC 61000-4-4	± 2 kV for power supply lines 100 kHz repetition frequency	In compliance	Mains power quality should be that of a typical hospital environment.
Surge IEC 61000-4-5	± 1 kV line(s) to line(s) ± 2 kV line(s) to earth	In compliance	Mains power quality should be that of a typical hospital environment.
Voltage dips, short interruptions and voltage variations on power supply input lines IEC 61000-4-11	0% U _T ; 0.5 Cycle At 0°, 45°, 90°, 135°, 180°, 225°, 270°, and 315° 0% U _T ; 1 cycle and 70% U _T ; 25/30 cycles Single Phase: at 0°	In compliance	Mains power quality should be that of a typical hospital environment. If the user of the system requires continued operation during power mains interruptions, it is recommended that the system be powered from an uninterruptible power supply or a battery.
Rated power frequency magnetic fields IEC 61000-4-8	30 A/m Frequency 50/60 Hz	In compliance	Power frequency magnetic fields should be at levels characteristic of a typical location in a typical hospital environment.
Conducted RF IEC 61000-4-6	3 V _{rms} 150 kHz to 80 MHz 6 V _{rms} in ISM bands 150 kHz to 80 MHz 80% AM at 1 kHz	In compliance	Portable and mobile RF communications equipment should be used no closer to any part of the system, including cables, than the recommended separation distance calculated from the equation applicable to the frequency of the transmitter. Recommended separation distance d (m) $d=1.2 \sqrt{P}$

Table 53. Guidance and Manufacturer’s Declaration—Electromagnetic Immunity

The system is intended for use in the electromagnetic environment specified below. The customer or the user of the system should ensure that it is used in such an environment.

IMMUNITY TESTS	IEC 60601 TEST LEVEL	COMPLIANCE LEVEL	ELECTROMAGNETIC ENVIRONMENT – GUIDANCE
Radiated RF IEC 61000-4-3	3 V/m 80 MHz to 2.7 GHz 80% AM at 1 kHz	In compliance	Interference may occur in the vicinity of equipment marked with the following symbol: 

Note: U_T is the AC mains voltage prior to application of the test level.

These guidelines may not apply in all situations. Electromagnetic propagation is affected by absorption and reflection from structures, objects and people.

Accessory Conformance to Standards

To maintain electromagnetic interference (EMI) within certified limits, the system must be used with the cables, components, and accessories specified or supplied by Verathon. For additional information, see the [Components](#) and [Product Specifications](#) sections. The use of accessories or cables other than those specified or supplied may result in increased emissions or decreased immunity of the system.

Table 54. EMC Standards for Accessories

ACCESSORY	MAX LENGTH
Core QuickConnect Cable	1.57 m (5ft)
Core 2m QuickConnect Cable	2.03 m (6.7ft)
Core Smart Cable (Single-use system)	1.45 m (5ft)
Core Video Cable (Re-usable system)	1.57 m (5 ft)
Spectrum Smart Cable	1.6 m (5.2 ft)
Titanium Single-Use Smart Cable	1.6 m (5.2 ft)
Titanium Video Cable	2.2 m (7.2 ft)

Glossary

The following table provides definitions for specialized terms used in this manual or on the product itself. For a full list of caution, warning, and informational symbols used on this and other Verathon products, please refer to the *Verathon Symbol Glossary* at verathon.com/service-and-support/symbols.

TERM	DEFINITION
A	Ampere
AC	Alternating current
AER	Automated endoscope reprocessor
C	Celsius
CFR	Code of Federal Regulations (U.S.)
CISPR	International Special Committee on Radio Interference
cm	Centimeter
CSA	Canadian Standards Association
DC	Direct current
DL	Direct laryngoscopy
ED	Emergency Department
EMI	Electromagnetic interference
EMS	Emergency Medical Services
ESD	Electrostatic discharge
Essential performance	The system performance necessary to achieve freedom from unacceptable risk
ETT	Endotracheal tube
F	Fahrenheit
g	Gram
GHz	Gigahertz
HDMI	High-definition multimedia interface
hPa	Hectopascal
Hz	Hertz
ICU	Intensive Care Unit
IEC	International Electrotechnical Commission
in	Inch
ISM	Industrial, scientific, and medical
ISO	International Standards Organization.
kHz	Kilohertz
kPa	Kilopascal
kV	Kilovolt
L	Liter
m	Meter

TERM	DEFINITION
mAh	Milliampere-hour
MDD	Medical Device Directive
MHz	Megahertz
mm	Millimeter
NICU	Neonatal Intensive Care Unit
OR	Operating Room
OSHA	Occupational Safety and Health Administration (federal agency in U.S.)
oz	Ounce
Reprocessing	Preparing a reusable component for its next use. Reprocessing includes cleaning, disinfection, and sterilization as appropriate.
RF	Radio frequency
RH	Relative humidity
SDS	Sodium dodecyl sulphate
V	Volt
Vrms	Voltage root mean squared
W	Watt
WEEE	Waste electrical and electronic equipment

verathon