



BFlex™ 2

Single-Use Bronchoscopes for GlideScope® Core™

Operations & Maintenance Manual

BFlex 2

Single-Use Bronchoscopes for GlideScope Core Operations & Maintenance Manual

Effective: 17 March 2025

Caution: Federal (United States) law restricts this
device to sale by or on the order of a physician.

Contact Information

To obtain additional information regarding your GlideScope system, please contact Verathon Customer Care or visit [verathon.com/service-and-support](https://www.verathon.com/service-and-support).

Verathon Inc.

20001 North Creek Parkway
Bothell, WA 98011 U.S.A.
Tel: +1 800 331 2313 (US and Canada only)
Tel: +1 425 867 1348
Fax: +1 425 883 2896
[verathon.com](https://www.verathon.com)



Verathon Medical (Canada) ULC

2227 Douglas Road
Burnaby, BC V5C 5A9
Canada
Tel: +1 604 439 3009
Fax: +1 604 439 3039



Verathon Medical (Europe) B.V.

Willem Fenengastraat 13
1096 BL Amsterdam
The Netherlands
Tel: +31 (0) 20 210 30 91
Fax : +31 (0) 20 210 30 92

Verathon Medical (Australia) Pty Limited

Unit 9, 39 Herbert Street
St Leonards NSW 2065
Australia
Within Australia: 1800 613 603 Tel / 1800 657 970 Fax
International: +61 2 9431 2000 Tel /
+61 2 9475 1201 Fax



MDSS CH GmbH

Laurenzenvorstadt 61
5000 Aarau
Switzerland



Anandic Medical Systems AG

Stadtweg 24
8245 Feuerthalen
Switzerland



Copyright © 2025 by Verathon Inc. All rights reserved. No part of this manual may be copied or transmitted by any method without the express written consent of Verathon Inc.

GlideScope, BFlex, Verathon, and all associated symbols are trademarks of Verathon Inc. All other brand and product names are trademarks or registered trademarks of their respective owners.

Not all Verathon Inc. products shown or described in this manual are available for commercial sale in all countries.

Information in this manual may change at any time without notice. For the most up-to-date information, see the documentation available at [verathon.com/service-and-support](https://www.verathon.com/service-and-support).

Table of Contents

- IMPORTANT INFORMATION 1**
 - Product Description 1
 - Statement of Intended Use 1
 - Indications for Use..... 1
 - Intended Patient Population 1
 - Intended Use Environment and User Population 2
 - Contraindications..... 2
 - Essential Performance 2
 - Environments of Intended Use 2
 - Statement of Prescription..... 2
 - Notice to All Users 2
 - Warnings & Cautions..... 2

- INTRODUCTION..... 9**
 - Parts & Accessories 10
 - Bronchoscope Components 11

- SETTING UP..... 12**
 - Perform Initial Inspection* 12
 - Attach the Video Cable to the Monitor* 12
 - Attach the Bronchoscope to the Video Cable* 13
 - Perform a Functional Check*..... 14

- USING THE DEVICE 15**
 - Procedure 1. Prepare the GlideScope System*..... 16
 - Procedure 2. Position the Handle and Controls* 17
 - Procedure 3. Insert Through a Tube or Catheter (Optional)*..... 18
 - Procedure 4. Insert and Flex the Bronchoscope* 19
 - Procedure 5. Introduce Liquids or Accessories (Optional)* 20
 - Procedure 6. Remove the Bronchoscope*..... 21

REPROCESSING22

MAINTENANCE & SAFETY23

 Periodic Inspections23

 Device Repair23

 Device Disposal.....23

WARRANTY24

PRODUCT SPECIFICATIONS26

 Specifications, Standards, and Approvals26

 Component Specifications27

 Electromagnetic Compatibility.....32

GLOSSARY35

Important Information

Product Description

The BFlex 2 Single-Use bronchoscope system includes the following components:

- Single-use bronchoscope
- Reusable monitor
- Reusable cable

The BFlex 2 device is a single-use bronchoscope which, when connected to a video monitor through a reusable cable, is intended to provide real time viewing and recording for a wide range of airway procedures.

Note: This manual covers the single-use bronchoscope and the reusable cable. For information about using a video monitor, refer to that monitor's Operations & Maintenance Manual.

Statement of Intended Use

The GlideScope BFlex 2 Single-Use bronchoscope is intended to work with the video monitor, in conjunction with nonpowered endoscopic accessories and other ancillary equipment, for endoscopy within the airways and tracheobronchial tree.

Indications for Use

The GlideScope BFlex 2 Single-Use Bronchoscope is indicated for endoscopic procedures of the airways and tracheobronchial tree.

Intended Patient Population

The BFlex 2 Single-Use system is for use in a hospital environment. All four BFlex 2 bronchoscopes are single-use devices designed for use in adults. BFlex 2 Ultraslim 2.8 and Slim 3.8 bronchoscopes are also designed for pediatric use. The BFlex 2 Ultraslim 2.8 has been tested at 6 months to 6 years and the BFlex 2 Slim 3.8 has been tested at 6 years. All BFlex 2 Single-Use bronchoscopes have been verified and validated for the following endotracheal tube (ETT) and endoscope accessory (EA) sizes:

MODEL	MINIMUM ETT INSIDE DIAMETER	EA MINIMUM WORKING CHANNEL WIDTH
BFlex 2 Ultraslim 2.8	4.0 mm	—
BFlex 2 Slim 3.8	5.0 mm	1.2 mm
BFlex 2 Regular 5.0	6.0 mm	2.2 mm
BFlex 2 Large 5.8	7.0 mm	3.0 mm

Note: There is no guarantee that instruments selected solely using these instrument dimensions will be compatible in combination.

Intended Use Environment and User Population

The BFlex 2 Single-Use Bronchoscope is intended for in-hospital use by physicians trained in the use of endoscopic equipment.

Contraindications

The BFlex 2 Ultraslim 2.8 Single-Use Bronchoscope does not have a working channel and therefore cannot be used for therapeutic purposes.

Essential Performance

The essential performance of the BFlex 2 Single-Use bronchoscope is visualization of the airway and tracheobronchial tree as well as certain procedures such as suction and use of endoscopic accessories sized to work with the dimensions of the bronchoscope.

Environments of Intended Use

The BFlex 2 Single-Use bronchoscope system is intended to be used in professional healthcare environments such as hospitals.

Statement of Prescription

Caution: Federal (United States) law restricts this device to sale by or on the order of a physician.

Notice to All Users

Verathon recommends that all users do the following:

- Read the manual before using the equipment.
- Obtain instruction from a qualified individual.
- Practice using the bronchoscope on a mannequin before clinical use.
- Acquire clinical training experience on patients without airway abnormalities.

Warnings & Cautions

Warnings indicate that injury, death, or other serious adverse reactions may result from use or misuse of the device. *Cautions* indicate that use or misuse of the device may cause a problem, such as a malfunction, failure, or damage to the product.

Warnings: Use



WARNING

Before every use, ensure that the instrument is operating correctly and has no sign of damage. Do not use this product if the device appears damaged. Refer servicing to qualified personnel.

Always ensure that alternative airway management methods and equipment are readily available.

Report any suspected defects to Verathon Customer Care. For contact information, visit verathon.com/service-and-support.



WARNING

No modification of this equipment is allowed.



WARNING

Do not use the power adapter in the presence of flammable anesthetics.



WARNING

Verathon has conducted no analysis to establish the compatibility of the system with environments where magnetic resonance imaging (MRI) equipment is installed. Because of this, the owner of the system must exclude it from any magnetic resonance (MR) environment.



WARNING

The video signals produced and used by this system are intended for device positioning only. Do not use the system as the sole diagnostic method of any pathology.



WARNING

Do not use this system during defibrillation.



WARNING

This instrument and related devices may contain batteries or other environmentally hazardous materials. When the instrument or accessories have reached the end of their useful service life, see the section Device Disposal. Dispose of used, single-use components as infectious waste.



WARNING

Two areas of the bronchoscope tip that contact the patient can exceed 41°C (106°F) as part of normal operation:

The first area is the light-emitting area surrounding the camera in the tip. When used as indicated, continuous contact with this area is unlikely because, if tissue were to contact this area, a usable view would be lost. Devices would then need to be adjusted to regain the working distance needed for a usable view.

The second area is the area of the tip that surrounds the camera, but is out of its field of view. Continuous contact with this area is unlikely because the product is typically not held stationary for an extended period of time, and because there is normally a small clearance between the area and the adjacent tissue.

To prevent thermal damage, such as a burn to the mucosal tissue, avoid prolonged, continuous contact with these areas of the bronchoscope tip.



WARNING

Do not use this system to deliver highly flammable anaesthetic gases to the patient. Such use may result in patient injury.



WARNING

When using suction, limit the vacuum level to 85 kPa (638 mmHg) or less. Higher vacuum levels may make it difficult to cut off suction if required.



WARNING

Do not use active endoscopic components such as laser probes or electrosurgical devices with this system. Such use may result in injury to the patient or damage to the system.



WARNING

Do not introduce accessories that exceed the maximum accessory width shown in the Product Specifications section or on the package label of the bronchoscope.



WARNING

Do not advance the bronchoscope while endoscopic accessories extend out of the opening in the distal tip. The resulting accessory movements may result in patient injury.



WARNING

Use caution when withdrawing endoscopic accessories from the patient.



WARNING

Before withdrawing the bronchoscope, place the distal tip into a straight, neutral position. While withdrawing, do not touch the control lever. Any bend in the distal tip may result in patient injury.



WARNING

If a malfunction should occur during use, do not continue the procedure. Place the distal tip into a straight, neutral position, and then slowly withdraw the bronchoscope without touching the control lever.



WARNING

Always watch the video display carefully while advancing or withdrawing the bronchoscope, flexing the distal tip, or applying suction. Failure to do so may result in injury to the patient.



WARNING

Before discarding a bronchoscope, ensure that no parts of the camera, distal tip, or insertion tube are missing.

Warnings: Reprocessing



WARNING

Do not reuse, reprocess, or resterilize single-use components. Reuse, reprocessing, or resterilization may create a risk of contamination of the device.

Warnings: Electrical



WARNING

To maintain electrical safety, use only the provided power supply. Connect the power cord and power adapter to a properly grounded plug, and ensure that the disconnect is easily accessible. Use only the accessories and peripherals recommended by Verathon.



WARNING

Electric shock hazard. Do not attempt to open the system components. This may cause serious injury to the operator or damage to the instrument and voids the warranty. Contact Verathon Customer Care for all servicing needs.



WARNING

Power Adapter Only: Electric shock hazard. Do not immerse the power adapter in water. When cleaning the power adapter, use a cloth dampened with isopropyl alcohol on the outside of the enclosure.



WARNING

Use of accessories and cables other than those specified or provided by Verathon may cause this system to experience electromagnetic malfunctions, including increased emissions or decreased immunity. This may cause improper operation, procedure delays, or both.



WARNING

Portable radio frequency communications equipment (including peripherals such as antenna cables and external antennas) may not be used within 30 cm (12 inches) of any part of the BFlex 2 Single-Use Bronchoscope system, including cables that Verathon specifies or provides for use with the system. If this distance is not maintained, performance of the system may be degraded and image display may be compromised.

Cautions: Use



CAUTION

Do not use a knife or other sharp instrument to open the packaging containing the bronchoscope, and do not use the bronchoscope if its packaging is damaged.



CAUTION

Before using an endoscopic accessory, ensure it is compatible with the working channel of the bronchoscope.



CAUTION

Do not use the system if it is not functioning properly or if it is damaged in any way.



CAUTION

Do not store BFlex 2 pouches in direct sunlight.



CAUTION

European Union only: If any serious incident occurs during use of this product, you must immediately notify Verathon (or its authorized representative), the Competent Authority of the Member State where the incident occurred, or both.



CAUTION

The BFlex 2 3.8 Single-Use Bronchoscope should not be used with 35Fr Shiley Endobronchial Tubes. Damage or tear to the BFlex 2 tip sheath may occur.



CAUTION

Do not use a BFlex holder as a handle when moving the Workstation. Using a BFlex holder as a handle may damage the holder.



CAUTION

Do not use excessive force when inserting, positioning, or removing the single-use bronchoscope or accessories. Using excessive force against resistance could result in product damage, including damage to or detachment of the distal tip.

Cautions: Reprocessing



CAUTION

QuickConnect Cable Only: For information on the handling and disposing of recommended reprocessing solutions, please refer to the solution manufacturer's instructions.



CAUTION

Risk of permanent equipment damage. This product is sensitive to heat, which causes damage to the electronics. Do not expose the system to temperatures above 45°C (113°F), and do not use autoclaves or pasteurizers. Use of such methods to clean or disinfect the system causes permanent device damage and voids the warranty. For a list of approved cleaning procedures and products, see the GlideScope Products Reprocessing Manual (part number 0900-5032).

Cautions: Electrical



CAUTION

Medical electrical equipment requires special precautions regarding electromagnetic compatibility (EMC) and must be installed and operated according to the instructions in this manual. For more information, see the Electromagnetic Compatibility section.

Avoid using the GlideScope system adjacent to or stacked with other equipment. If adjacent or stacked use is necessary, observe the system to verify normal operation in the configuration in which it will be used.

This device can radiate radio frequency energy and is highly unlikely to cause harmful interference with other devices in the vicinity. There is no guarantee that interference will not occur in a particular installation. Evidence of interference may include degradation of performance in this device or other devices when operated simultaneously. If this occurs, try to correct the interference and restore optimal image quality by using the following measures:

- Turn devices on and off in the vicinity to determine the source of interference
- Reorient or relocate this device or other devices
- Increase the separation between devices
- Power off and on the monitor if the image quality is not optimal after removal of the interference
- Connect the device to an outlet on a circuit different than the other device(s)
- Eliminate or reduce EMI with technical solutions (such as shielding)
- Purchase medical devices that comply with IEC 60601-1-2 EMC standards

Be aware that portable and mobile radio frequency communications equipment (cellular phones, etc.) may affect medical electrical equipment; take appropriate precautions during operation.

Introduction

This manual discusses the following components of the BFlex 2 Single-Use Bronchoscope system:

- BFlex 2 bronchoscope (single-use)
- GlideScope Core QuickConnect Cable (reusable)





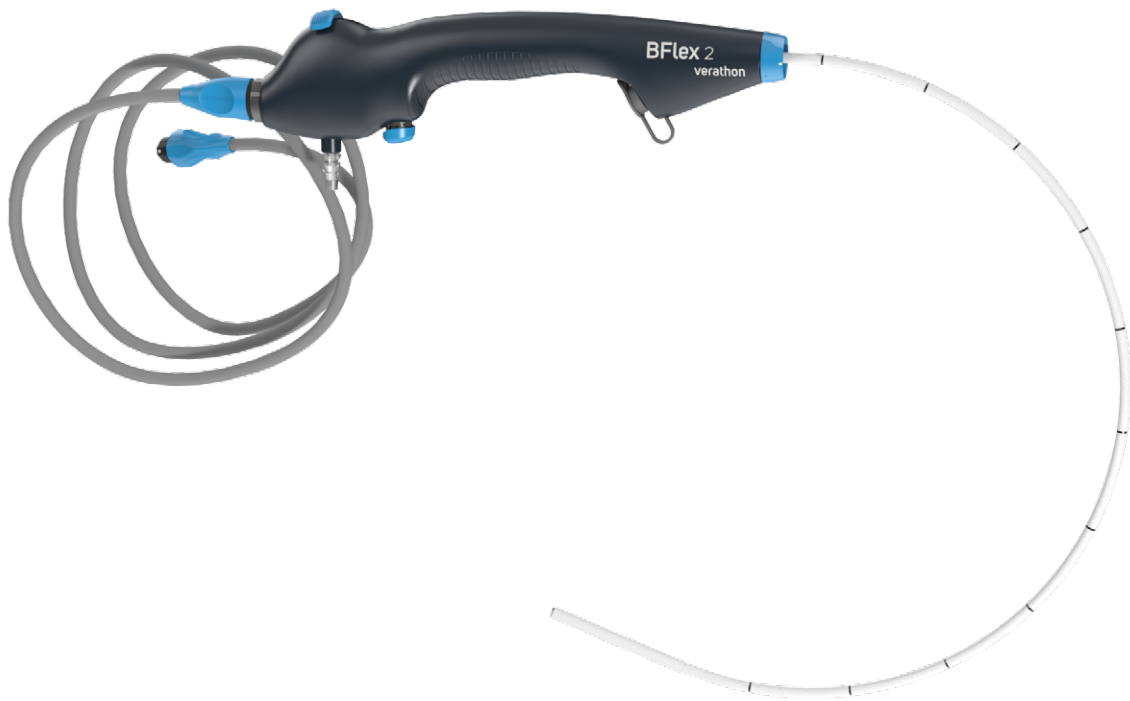

Note: This manual covers the single-use bronchoscope and the reusable cables. For information about using a video monitor, refer to that monitor's Operations & Maintenance Manual.

Figure 1. BFlex 2 Single-Use Bronchoscope and Cable

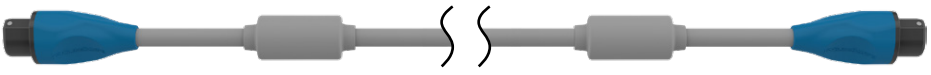

Parts & Accessories

Table 1. System Components

BRONCHOSCOPES	
BFlex 2	
	BFlex 2 Ultraslim 2.8 Single-Use bronchoscope
	BFlex 2 Slim 3.8 Single-Use bronchoscope
	BFlex 2 Regular 5.0 Single-Use bronchoscope
	BFlex 2 Large 5.8 Single-Use bronchoscope
Accessories	
	GlideScope Core QuickConnect Cable
	Introducer 

Bronchoscope Components

The BFlex 2 bronchoscope is a single-use device that can be inserted either directly or through an endotracheal (ET) tube. The main components of the bronchoscope are shown in the following figure.

Figure 2. Bronchoscope Components

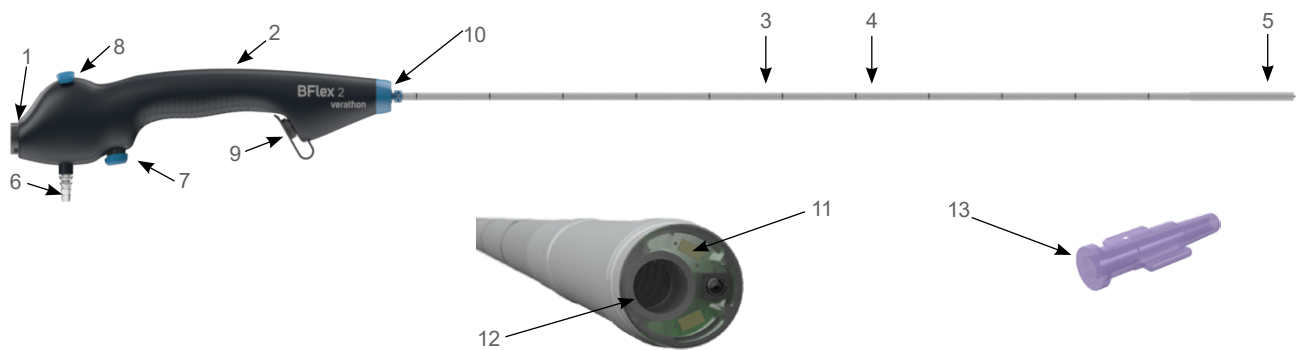

Table 2. Bronchoscope Component Descriptions

FIGURE KEY	COMPONENT	NOTES
1	Cable connector	Includes magnetic quick release.
2	Handle	—
3	Insertion tube	—
4	Positioning marks	Includes marks at 5 cm (50 mm) intervals to assist in scope placement within the airway.
5	Articulating distal tip	—
6*	Suction port	Accommodates tubing with an inside diameter between 6.0 and 7.0 mm, inclusively.
7*	Suction button	—
8	Control lever	Positions articulating distal tip.
9*	Accessory port and accessory port cap	Enables introduction of accessories or liquids.
10	Tube retainer	Enables mounting of endotracheal (ET) tubes with standard ISO connectors (and endobronchial double lumen [DL] tubes for BFlex 2 Slim 3.8 and Ultraslim 2.8).
11	Camera and light	High-resolution, full-color camera with integrated LED light source and anti-fog protection.
12*	Working channel	—
13*	Introducer	Connects Luer syringes securely to the accessory port.

* Does not apply to BFlex 2 Ultraslim 2.8.

Setting Up

Before you can use the system for the first time, you must inspect the components, set up the system, and perform a functional test as recommended by Verathon. Complete the following tasks:

1. **Perform Initial Inspection**—Inspect the system for any obvious physical damage that may have occurred during shipment.
2. **Attach the Video Cable to the Monitor**—Connect the QuickConnect cable to the monitor.
3. **Attach the Bronchoscope to the Video Cable**—Connect the bronchoscope to the cable.
4. **Perform a Functional Check**—Before you use the device for the first time, perform a functional check to ensure that the system is working properly.

Perform Initial Inspection

When you receive the system, Verathon recommends that an operator familiar with the instrument perform a full visual inspection of the system for any obvious physical damage that may have occurred during shipment.

1. Verify that you have received the appropriate components for your system by referring to the packing list included with the system.
2. Inspect the components for damage.
3. If any of the components are missing or damaged, notify the carrier and Verathon Customer Care or your local representative. For contact information, visit verathon.com/service-and-support.

Attach the Video Cable to the Monitor

This procedure provides basic instruction on connecting video cables to a monitor. For information on a specific monitor, please refer to its Operations & Maintenance Manual, or contact Verathon Customer Care.

1. Align the dot on cable connector to the dot on one of the monitor's video connectors, and then fully insert the cable. The connector attaches to the monitor.

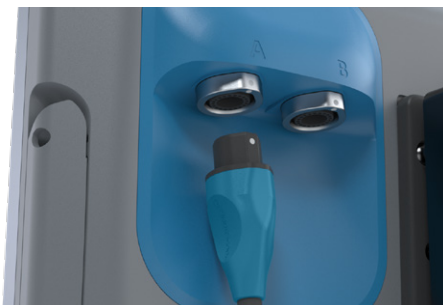

2. To disconnect the video cable, hold the cable connector in one hand and support the monitor with the other, and then pull. The cable disconnects from the monitor.

Attach the Bronchoscope to the Video Cable

IMPORTANT

When using a Core 2m QuickConnect Cable, ensure the Core 15 monitor software is updated to the following versions or later:

- Version 1.8—Core 15 FHD (0570-0437)
- Version 1.10—Core 15 (0570-0404)

The GlideScope QuickConnect Cable attaches the bronchoscope to the monitor, supplying power to the bronchoscope and transmitting video data from the camera to the monitor.

It is recommended that you leave the sterile, single-use bronchoscope in the packaging while connecting it, and that you do not remove the bronchoscope until you are ready to insert it. This helps ensure that the bronchoscope remains as clean as possible.

1. If necessary, connect the cable to the monitor according to the procedure [Attach the Video Cable to the Monitor](#) on [page 12](#).
2. Remove the bronchoscope and the introducer from their packets.
3. Detach the protective cover from the cable connector on the bronchoscope. Discard the cover after you remove it.



4. If you are using a BFlex holder, place the BFlex 2 with the protective sleeve in the holder. Otherwise, carefully slide the protective sleeve off the insertion tube of the bronchoscope.



5. Inspect the bronchoscope to ensure that it is functional..

- Align the white dot on the opposite end of the QuickConnect Cable with the dot on the bronchoscope, and then insert the connector into the bronchoscope. Magnets in both components hold them in place during use.

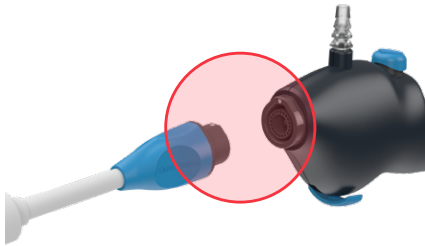

- To disconnect a bronchoscope from the QuickConnect Cable, hold the cable connector in one hand and the handle of the bronchoscope in the other, and then pull. The bronchoscope disconnects from the cable.

Perform a Functional Check

Before you use the device for the first time, perform the following functional check to ensure that the system is working properly. Please contact your Verathon Customer Care representative if your system does not function as described below.

- Fully charge the monitor battery (this takes approximately 6 hours).
- Attach a QuickConnect Cable and a bronchoscope to the monitor, according to the instructions in [Attach the Video Cable to the Monitor](#) on page 12 and [Attach the Bronchoscope to the Video Cable](#) on page 13.
- Turn the monitor on.
- Look at the monitor screen, and verify that the image displayed is being received from the bronchoscope.

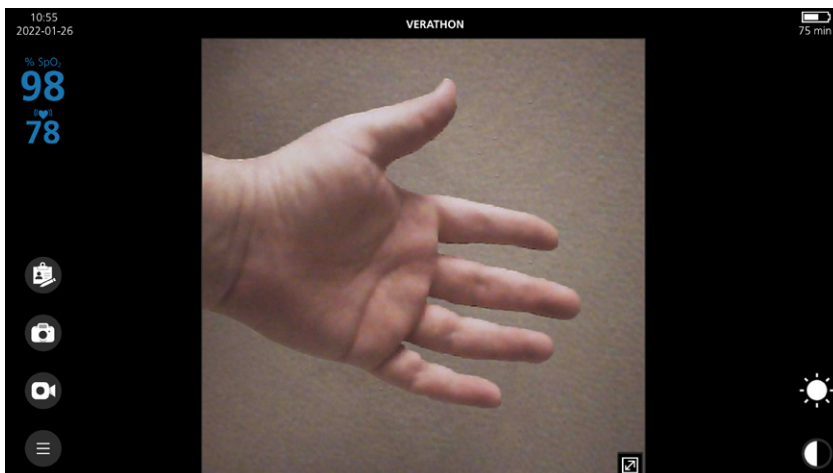

Using the Device

Before use, set up the device according to the instructions in the previous chapter, and verify the setup by completing the procedure [Perform a Functional Check](#) on page 14.



Please read the [Warnings & Cautions](#) section before performing the following tasks.

BFlex 2 Single-Use bronchoscopes are equipped with an anti-fog feature that reduces camera fogging during use. To optimize the feature fully, you must allow the bronchoscope to warm up for 30–120 seconds prior to use, depending on the ambient temperature and humidity of the clinical environment. Full warmup is not necessary to use the device; if desired, you may begin the insertion procedure immediately.

Using the BFlex 2 components consists of the following:

- [Prepare the GlideScope System](#)
- [Position the Handle and Controls](#)
- [Insert Through a Tube or Catheter \(Optional\)](#)
- [Insert and Flex the Bronchoscope](#)
- [Introduce Liquids or Accessories \(Optional\)](#)
- [Remove the Bronchoscope](#)

Note: Follow accepted practices in order to protect the bronchoscope from contamination prior to insertion.

Procedure 1. Prepare the GlideScope System

In this procedure, you turn the system on and verify that it is functioning properly.

1. Ensure that each GlideScope component has been properly cleaned.
2. Attach the QuickConnect cable and the bronchoscope to the monitor, according to the instructions in the monitor's Operations & Maintenance Manual.
3. If you need to deliver suction through the working channel of the bronchoscope, connect a suction line to the suction port.*

Note: The inside diameter of the suction tubing should be between 6.0 and 7.0 mm, inclusively.

4. Turn on the monitor.

Note: If the monitor locks up, becomes unresponsive for any reason, or does not show an image from the bronchoscope, consult the monitor's Operations & Maintenance Manual for resetting instructions.

5. Ensure that the battery is sufficiently charged. If necessary, connect the monitor directly to power.
6. On the monitor screen, verify that the image displayed is from the bronchoscope camera.
7. If needed, allow the GlideScope anti-fog feature to warm up for 30–120 seconds.

Note: The time required for the anti-fog feature to be fully optimized varies according to the ambient temperature and humidity where the equipment is being stored or used. If the bronchoscope is stored in cold conditions, additional warming time may be required for optimal performance of the anti-fog feature.

* Does not apply to BFlex 2 Ultraslim 2.8.

Procedure 2. Position the Handle and Controls

With your supporting hand positioned as described in this procedure, you can regulate suction with your index finger and position the distal tip of the bronchoscope with your thumb. You can then use your other hand to introduce accessories or liquids through the working channel, to grasp and turn the insertion tube, or to provide additional support as appropriate. If you need to do several of these things at once, you may need a second person to assist.

1. Empty the hand you will use to support and operate the bronchoscope.
2. Using that hand, grasp the handle in the center.
3. Place the positioning lever under your thumb.
4. Place the suction button under your index finger. Press the button as needed to apply suction.*

Note: To ensure full suction strength, remove any object such as a syringe or an endoscopic accessory from the working channel while applying suction.

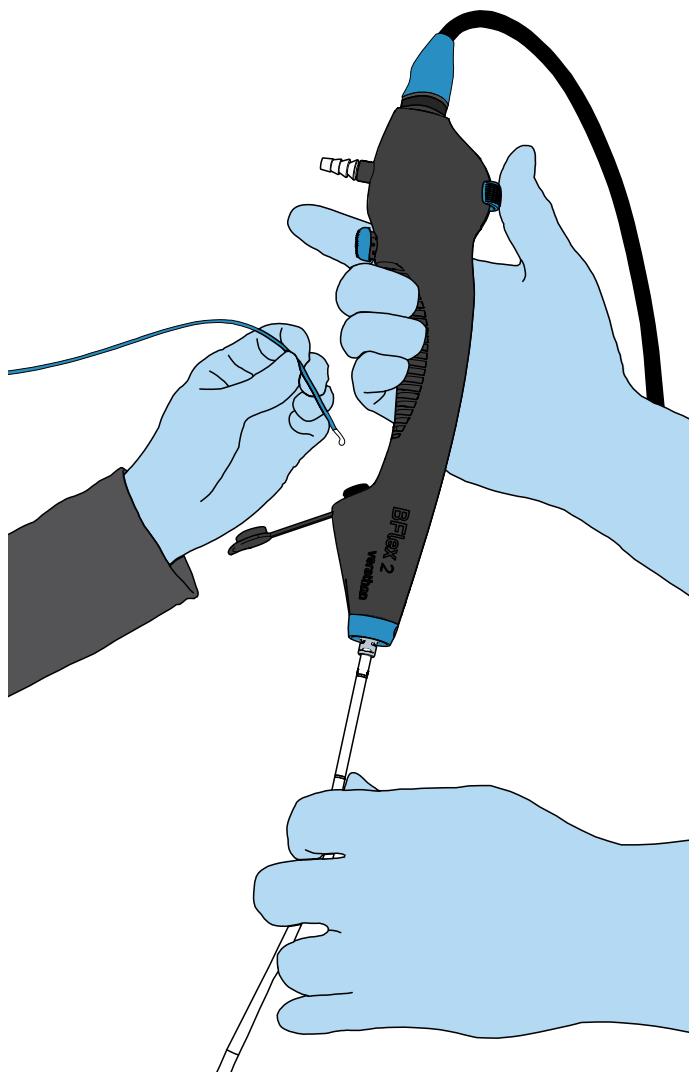

* Does not apply to BFlex 2 Ultraslim 2.8.

Procedure 3. Insert Through a Tube or Catheter (Optional)

IMPORTANT

Verathon has tested compatibility with water based, silicone based, and petroleum based lubricants.

The bronchoscope can be inserted through a tube or catheter with a compatible inside diameter, as shown in the following table.

Table 3. BFlex 2 Bronchoscope—Endotracheal Tube Compatibility

TUBES AND CATHETERS	SPECIFICATION	ULTRASLIM 2.8	SLIM 3.8	REGULAR 5.0	LARGE 5.8
Endotracheal tube	Minimum Inside Diameter	4.0 mm	5.0 mm	6.0 mm	7.0 mm
Percutaneous Dilatational Tracheostomy (PDT) tube	Minimum Inside Diameter	4.0 mm	5.0 mm	6.0 mm	7.0 mm
Double-Lumen tube	Minimum Size	32 Fr	35 Fr	Not supported	
Airway catheter	Minimum Size	19 Fr	19 Fr		
	Minimum Inside Diameter	4.7 mm	4.7 mm		
	Maximum length	560 mm	560 mm		
Bronchial blocker	Follow the bronchial blocker manufacturer's guidance for scope size compatibility.				

Note: There is no guarantee that instruments selected solely using these instrument dimensions will be compatible in combination. Importantly, The BFlex 2 Slim 3.8 Single-Use Bronchoscope should not be used with 35Fr Shiley Endobronchial Tubes. Damage or tear to BFlex 2 tip sheath may occur.

1. Remove your thumb from the positioning lever of the bronchoscope and ensure that the distal tip is completely straight and in a neutral position.
2. Lubricate the scope, tube, or catheter, and then slowly insert the distal tip of the bronchoscope into the internal channel of the tube or catheter. If you encounter resistance while inserting the bronchoscope, pull the scope back slightly, ensure your thumb is not on the positioning lever, and then continue inserting the bronchoscope.
If there is ongoing resistance, consider the following:
 - Apply additional lubrication to the scope, tube, or catheter.
 - Use a smaller diameter bronchoscope or a larger diameter tube or catheter.
3. As you slide the bronchoscope through the tube or catheter, keep your thumb off of the positioning lever until the monitor image and the markings on the bronchoscope indicate that the distal tip has emerged completely from the distal end of the tube or catheter.
4. After the distal tip has emerged from the tube or catheter, return your thumb to the positioning lever. Follow the positioning instructions in the following section, [Insert and Flex the Bronchoscope](#), to maneuver the tip to its working location.

- If you are using an endotracheal tube or double lumen tube, slide the tube's connector into the tube retainer of the bronchoscope, and then press it securely into place.



Procedure 4. Insert and Flex the Bronchoscope

The bronchoscope can be inserted using any standard oral or nasal insertion technique, with or without the use of a separate ET tube. During use, its distal tip can flex through the ranges shown in the following table.

Table 4. BFlex 2 Bronchoscope—Distal Tip Articulation

SIZE	RANGE OF MOVEMENT OF DISTAL TIP*
BFlex 2 Ultraslim 2.8	185° flex, 195° retroflex
BFlex 2 Slim 3.8	180° flex, 185° retroflex
BFlex 2 Regular 5.0	215° flex, 225° retroflex
BFlex 2 Large 5.8	190° flex, 205° retroflex

* Values shown are averages following the sterilization stage of manufacturing.

As you perform the insertion, use the following steps to direct the distal tip of the bronchoscope.

Note: If necessary, the bronchoscope can be wiped gently with sterile gauze.

- Using your thumb, move the positioning lever to flex the distal tip as needed. The tip flexes with the lever as shown in the figures to the right.
- As you carefully advance and flex the distal tip, rotate the handle around its long axis. By combining all three movements, you can direct the tip to any point in the direction of insertion.
- Observe the black markings on the insertion tube of the bronchoscope in order to determine depth. These markings are spaced at 5 cm intervals. The first mark appears at the inward edge of the tip itself, marking the tip as 10 cm long.



Flex

Retroflex

Procedure 5. Introduce Liquids or Accessories (Optional)



Please read the [Warnings & Cautions](#) section before performing the following task.

IMPORTANT

The BFlex 2 Ultraslim 2.8 does not have suction capability.

In addition to supplying suction, the working channel on the bronchoscope also provides a delivery channel for the following items:

- Liquids such as sterile saline solution
- Endoscopic tools that do not require their own source of electrical power (non-powered tools) such as forceps, cutters, baskets, or brushes

The following table shows minimum inside diameter of the working channel for each size of bronchoscope. For compatibility, please refer to tool or accessory manufacturer's documentation.

Table 5. BFlex 2 Bronchoscope—Minimum inside diameter of working channel

SIZE	MINIMUM INSIDE DIAMETER OF WORKING CHANNEL
BFlex 2 Ultraslim 2.8	Not applicable. No working channel.
BFlex 2 Slim 3.8	1.2 mm
BFlex 2 Regular 5.0	2.2 mm
BFlex 2 Large 5.8	3.0 mm

Use the following steps to introduce liquids or accessories through the working channel.

Option 1. Administering Liquids

1. Aspirate the solution into a syringe, if you have not already done so.
2. If you are using a slip-tip syringe to administer the liquid, fully insert the tip of the syringe into the accessory port. If you are using a luer lock syringe, use the included introducer to connect the syringe to the port.



3. Dispense the liquid into the working channel.

Note: If suction is connected to the bronchoscope, do not apply suction while you are introducing the liquid. This causes the suction to withdraw the liquid from the bronchoscope. Conversely, to ensure full suction strength, retract the syringe or introducer while applying suction.

Option 2. Introducing Non-Powered Endoscopic Accessories

1. Move the positioning lever in order to return the distal tip as close to a straight position as possible.
2. If appropriate, position the accessory so that its distal end is collapsed as far as possible.
3. Insert the distal end of the accessory into the working channel.



4. Slide the accessory through the working channel until its end emerges from the distal tip of the bronchoscope, as shown on the monitor screen.
5. Position the distal tip of the bronchoscope and the accessory as needed to perform the procedure.

Note: To ensure full suction strength, retract the accessory from the working channel before applying suction.

Procedure 6. Remove the Bronchoscope

If you intend to use the bronchoscope with the same patient more than once, prepare a sterile resting area for it. If you are using a BFlex 2 with a BFlex holder, the holder can be used as an intra-operative storage location. Keep the bronchoscope in this area when it is not in use.

1. When possible, retract any accessories into the working channel in order to avoid interference with the distal tip during removal.
2. Return the positioning lever as close to center as possible, and then remove your thumb from the positioning lever.
3. Carefully withdraw the bronchoscope without touching the control lever.

Note: If you encounter resistance during withdrawal, reinsert the bronchoscope slightly, and then gently rotate it, straighten the tube, or instill saline into the tube, and then attempt removal again.

4. After you have withdrawn the bronchoscope completely, examine it thoroughly. Verify that it is not damaged and none of its components are missing.
5. If necessary, detach the cable from the bronchoscope by holding the cable connector in one hand and the bronchoscope handle in the other, and then pulling them straight apart.
6. When the procedure is complete, dispose of the bronchoscope according to your local protocols for bio-hazard waste.

Reprocessing

Some of the components in this manual may require cleaning, low-level disinfection, high-level disinfection, or sterilization between uses or under specific circumstances. For information about the cleaning, disinfection, and sterilization requirements for these components, refer to the GlideScope and GlideRite Products Reprocessing Manual, which is available at [verathon.com/service-and-support/glidescope-reprocessing-products](https://www.verathon.com/service-and-support/glidescope-reprocessing-products).

Maintenance & Safety

Periodic Inspections

No periodic inspections, maintenance, or calibrations are required by Verathon.

Report any suspected defects to Verathon Customer Care or your local representative. For contact information, visit verathon.com/service-and-support.

Device Repair

The cables are not user-serviceable. Verathon does not make available any type of circuit diagrams, component parts lists, descriptions, or other information that would be required for repairing the device and related accessories. All service must be performed by a qualified technician.

If you have any questions, contact your local Verathon representative or Verathon Customer Care.



Please read the [Warnings & Cautions](#) section.

Device Disposal

The system and related accessories may contain batteries and other environmentally hazardous materials. When the instrument has reached the end of its useful service life, it must be disposed of in accordance with WEEE requirements. Coordinate disposal through your Verathon Service Center, or alternatively, follow your local protocols for hazardous waste disposal.

Warranty

ORIGINAL FIRST YEAR TOTAL CUSTOMER CARE WARRANTY

Verathon warrants the system against defects in material and workmanship. The limited warranty applies for one (1) year from the date of shipment from Verathon and applies only to the original purchaser of the system. The terms of this warranty are subject to the *Terms and Conditions of Sale* or any other contractual document between the parties.

Verathon's policy is to honor product warranties and to perform services only on products purchased from an authorized Verathon dealer. If you purchase a Verathon product or system components from an unauthorized dealer or if the original factory serial number has been removed, defaced or altered, your Verathon warranty will be void. Purchasing Verathon products from unauthorized entities could result in receipt of product that is counterfeit, stolen, used, defective, or not intended for use in your region.

If a customer's system requires service or repair, Verathon will, at its discretion, either repair or replace the customer's unit and provide a loaner unit. The customer agrees to send the defective unit to Verathon (cleaned and disinfected as appropriate) upon receipt of the loaner unit, and the customer agrees to return the loaner unit within two (2) business days of receipt of the repaired unit. All exchanged parts become property of Verathon.

Each product manufactured by Verathon is warranted to be free from defects in material and workmanship under normal use and services. Verathon's warranty does not cover defects or problems caused by the buyer's acts (or failure to act), the acts of others, or events beyond Verathon's reasonable control. The buyer shall be solely responsible, for any problem, failure, malfunction, defect, claim, damage, liability, or safety issue arising out of the following:

- Accident, theft, misuse, abuse, extraordinary wear and tear, or neglect.
- Misapplication, improper use, or other failure to follow Verathon's product instructions and safety precautions. The system shall be used in accordance with the instructions contained in this manual. This warranty does not apply if there is evidence of the equipment being exposed to temperatures in excess of 60°C (140°F).
- Use of the system in conjunction with hardware, software, components, services, accessories, attachments, interfaces, or consumables, other than those supplied or specified by Verathon.
- Products that have been repaired or maintained by anyone other than a Verathon authorized service provider. Modification, disassembly, rewiring, re-engineering, recalibration, and/or reprogramming of products other than as specifically authorized by Verathon in writing is prohibited and will void all warranties.

This warranty provides coverage if the instrument is rendered inoperable as a result of an accidental drop or mishandling after payment by the buyer of the current deductible as determined by Verathon. The deductible charge will be applied on each warranty request and may be applied an unlimited number of times per instrument.

WHAT IS COVERED?

Warranty coverage applies to the following system components:

- GlideScope Core QuickConnect Cable

Additional reusable components purchased either singularly or as a part of a system are warranted separately. Consumable items are not covered under this warranty.

PREMIUM CUSTOMER CARE WARRANTY

You may purchase a Premium Total Customer Care warranty that extends the limited warranty. For more information, contact Verathon Customer Care or your local representative.

DISCLAIMER OF ADDITIONAL WARRANTIES

There are no understandings, agreements, representations of warranties expressed or implied (including warranties of merchantability or fitness for a particular purpose) other than those set forth in this chapter and the *Terms and Conditions of Sale*. The contents of this manual do not constitute a warranty.

Some states disallow certain limitations on applied warranties. The purchaser should consult state law if there is a question regarding this disclaimer. The information, descriptions, recommendations, and safety notations in this manual are based upon Verathon experience and judgment. The contents of this manual should not be considered to be all-inclusive or to cover all contingencies.

Product Specifications

Specifications, Standards, and Approvals

Table 6. Specifications

GENERAL SPECIFICATIONS		
Ingress protection against water:	Single-use bronchoscope	IPX0
	QuickConnect Cable (all)	IPX7
Expected product life:	Single-use bronchoscope (all)	Refer to the “use by” date indicated by the  symbol on the package label.
OPERATING, SHIPPING, & STORAGE SPECIFICATIONS		
Operating Conditions		
Temperature:	Single-Use Bronchoscopes	10–40°C (50–104°F)
	QuickConnect Cables	
Relative humidity:	Single-Use Bronchoscopes	10–95%
	QuickConnect Cables	
Atmospheric pressure:	Single-Use Bronchoscopes	700–1060 hPa
	QuickConnect Cables	
Shipping Conditions		
Temperature:	Single-Use Bronchoscopes	-20–45°C (-4–113°F)
	QuickConnect Cables	
Relative humidity:	Single-Use Bronchoscopes	10–95%
	QuickConnect Cables	
Atmospheric pressure:	Single-Use Bronchoscopes	440–1060 hPa
	QuickConnect Cables	
Storage Conditions		
Temperature:	Single-Use Bronchoscopes	18–28°C (64–82°F)
	QuickConnect Cables	-20–45°C (-4–113°F)
Relative humidity:	Single-Use Bronchoscopes	40–60%
	QuickConnect Cables	10–95%
Atmospheric pressure:	Single-Use Bronchoscopes	1013 hPa
	QuickConnect Cables	440–1060 hPa



Please read the [Warnings & Cautions](#) section.

Component Specifications

Table 7. *GlideScope Core QuickConnect Cable (0600-0767)*

SPECIFICATION	VALUE
Length (A)	1524 ± 50 mm
Diameter (B)	6.8 mm

The diagram shows a long, thin cable with blue connectors at both ends. A dimension line labeled 'A' spans the entire length of the cable. A dimension line labeled 'B' indicates the diameter of the cable in the middle section.

Table 8. *BFlex Holder (0810-0293)*

SPECIFICATION	VALUE
Width (A)	220 mm (8.7 in)
Length (B)	281 mm (11.1 in)
Height (C)	182 mm (7.2 in)
Weight	249 g

The diagram shows a U-shaped metal holder. Dimension 'A' is the horizontal width from the base of the left arm to the vertical part of the right arm. Dimension 'B' is the diagonal length of the left arm. Dimension 'C' is the vertical height from the base of the right arm to the top of the hook.

Table 9. BFlex 2 Ultraslim 2.8 (0570-0434)

SPECIFICATION	VALUE
Length of flexible insertion tube from distal tip (A)	610 mm
Outside diameter of flexible insertion tube (B)	2.8 mm
Maximum outside diameter of flexible insertion tube and distal tip (C)	3.3 mm
Minimum inside diameter of endotracheal tube	4.0 mm
Depth of field (D)	5–50 mm
Direction of view, relative to center line of distal tip	0°
Field of view, horizontal/vertical (E)	85°
Field of view, diagonal (F)	120°

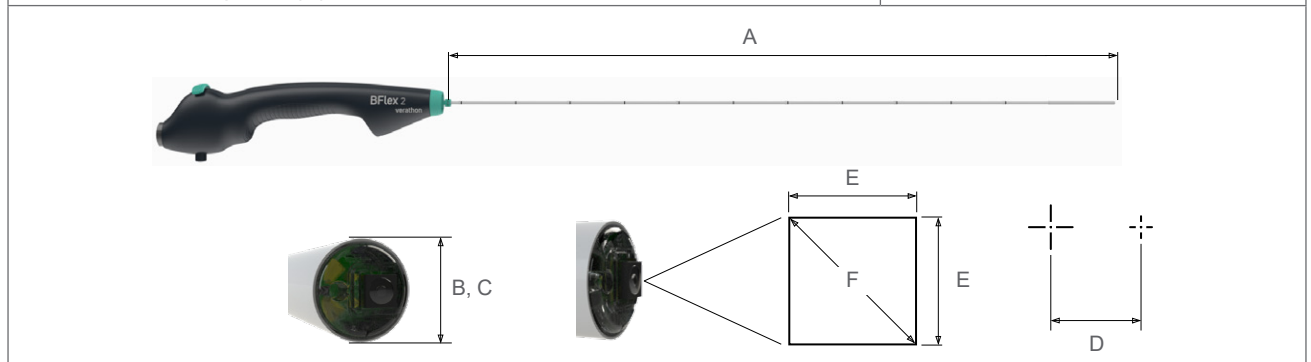
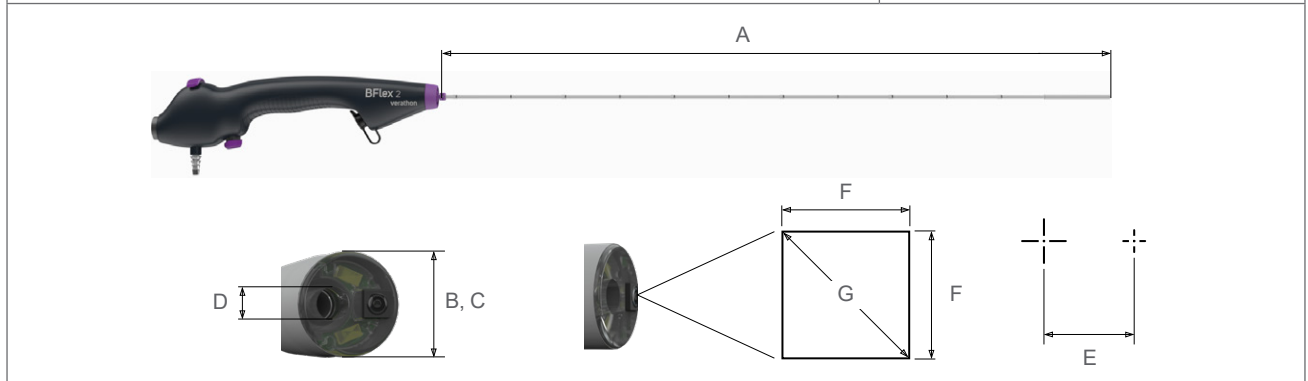

Table 10. BFlex 2 Slim 3.8 (0570-0432)

SPECIFICATION	VALUE
Length of flexible insertion tube from distal tip (A)	610 mm
Outside diameter of flexible insertion tube (B)	3.8 mm
Maximum outside diameter of flexible insertion tube and distal tip (C)	4.4 mm
Minimum inside diameter of endotracheal tube	5.0 mm
Average Inside diameter of working channel (D)	1.2 mm
Minimum inside diameter of working channel (D)	1.2 mm*
Maximum accessory width	1.0 mm
Length of working channel	696 mm†
Volume of working channel	0.98 cc (0.98 mL)
Depth of field (E)	5–50 mm
Direction of view, relative to center line of distal tip	0°
Field of view, horizontal/vertical (F)	85°
Field of view, diagonal (G)	120°



* There is no guarantee that accessories selected solely using this minimum instrument channel width will be compatible in combination.

† There is no guarantee that accessories selected solely using maximum insertion portion width and working length will be compatible in combination.

Table 11. BFlex 2 Regular 5.0 (0570-0423)

SPECIFICATION	VALUE
Length of flexible insertion tube from distal tip (A)	610 mm
Outside diameter of flexible insertion tube (B)	5.0 mm
Maximum outside diameter of flexible insertion tube and distal tip (C)	5.5 mm
Minimum inside diameter of endotracheal tube	6.0 mm
Average inside diameter of working channel (D)	2.2 mm
Minimum inside diameter of working channel (D)	2.2 mm*
Maximum accessory width	2.0 mm
Length of working channel	696 mm†
Volume of working channel	2.77 cc (2.77 mL)
Depth of field (E)	5–50 mm
Direction of view, relative to center line of distal tip	0°
Field of view, horizontal/vertical (F)	85°
Field of view, diagonal (G)	120°

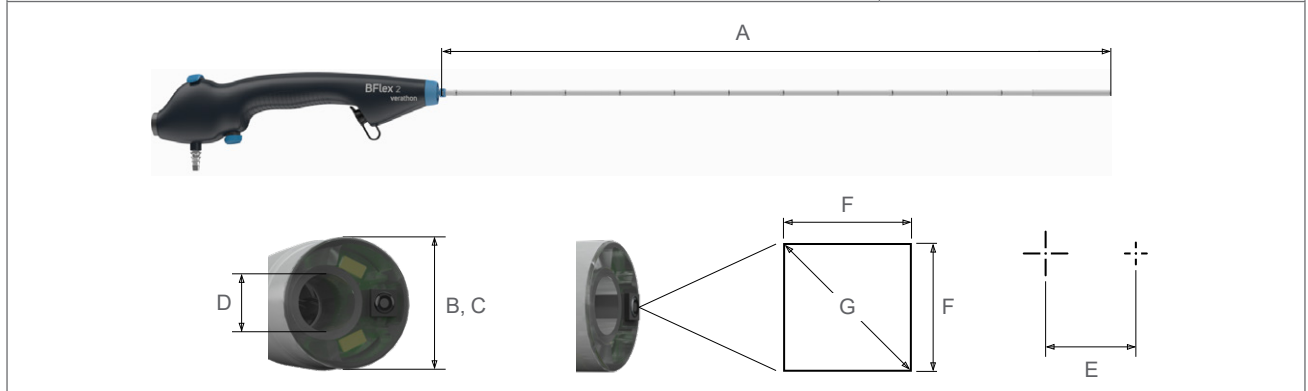

* There is no guarantee that accessories selected solely using this minimum instrument channel width will be compatible in combination.
 † There is no guarantee that accessories selected solely using maximum insertion portion width and working length will be compatible in combination.

Table 12. BFlex 2 Large 5.8 (0570-0424)

SPECIFICATION	VALUE
Length of flexible insertion tube from distal tip (A)	610 mm
Outside diameter of flexible insertion tube (B)	5.8 mm
Maximum outside diameter of flexible insertion tube and distal tip (C)	6.35 mm
Minimum inside diameter of endotracheal tube	7.0 mm
Average inside diameter of working channel (D)	3.0 mm
Minimum inside diameter of working channel (D)	3.0 mm*
Maximum accessory width	2.6 mm
Length of working channel	696 mm†
Volume of working channel	5.2 cc (5.2 mL)
Depth of field (E)	5–50 mm
Direction of view, relative to center line of distal tip	0°
Field of view, horizontal/vertical (F)	85°
Field of view, diagonal (G)	120°

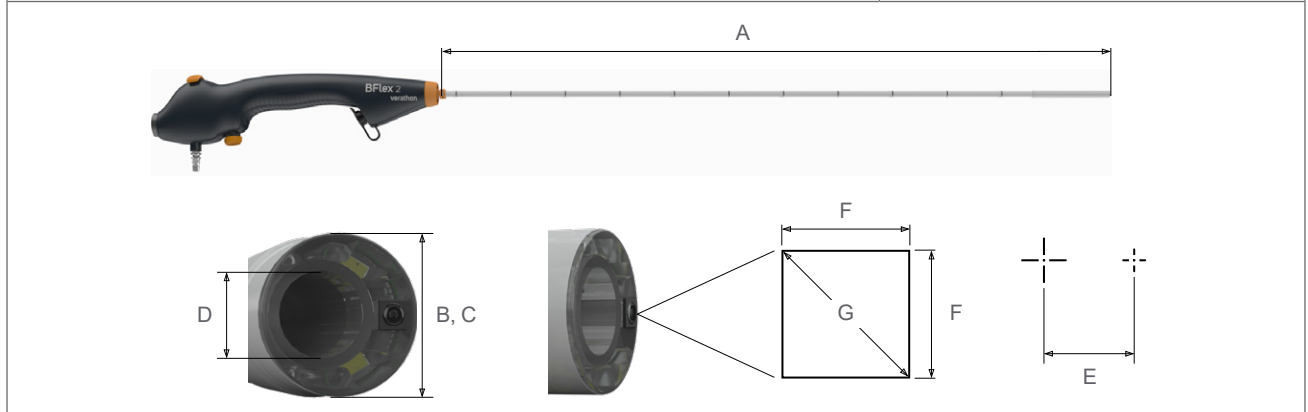

* There is no guarantee that accessories selected solely using this minimum instrument channel width will be compatible in combination.

† There is no guarantee that accessories selected solely using maximum insertion portion width and working length will be compatible in combination.

Electromagnetic Compatibility

The BFlex 2 system is designed to be in compliance with IEC 60601-1-2, which contains electromagnetic compatibility (EMC) requirements for medical electrical equipment. The limits for emissions and immunity specified in this standard are designed to provide reasonable protection against harmful interference in a typical medical installation.

The system complies with the applicable essential performance requirements specified in IEC 60601-1 and IEC 60601-2-18. Results of immunity testing show that the essential performance of the system is not affected under the test conditions described in the following tables. For more information about the essential performance of the BFlex 2 system, see [Essential Performance](#) on page 2.

Electromagnetic emissions

Table 13. Guidance and Manufacturer's Declaration—Electromagnetic Emissions

The system is intended for use in the electromagnetic environment specified below. The customer or the user of the system should ensure that it is used in such an environment.

EMISSIONS TEST	COMPLIANCE	ELECTROMAGNETIC ENVIRONMENT – GUIDANCE
RF emissions CISPR 11	Group 1	The system uses RF energy only for its internal function. Therefore, its RF emissions are very low and are not likely to cause any interference in nearby electronic equipment.
RF emissions CISPR 11	Class A	The system is suitable for use in all establishments other than domestic and those directly connected to the public low-voltage power supply network that supplies buildings used for domestic purposes.
Harmonic emissions IEC 61000-3-2	Class A	
Voltage fluctuations/ flicker emissions IEC 61000-3-3	In compliance	

Electromagnetic immunity

Table 14. Guidance and Manufacturer's Declaration—Electromagnetic Immunity

The system is intended for use in the electromagnetic environment specified below. The customer or the user of the system should ensure that it is used in such an environment.

IMMUNITY TESTS	IEC 60601 TEST LEVEL	COMPLIANCE LEVEL	ELECTROMAGNETIC ENVIRONMENT – GUIDANCE
Electrostatic discharge (ESD) IEC 61000-4-2	± 8 kV contact ± 15 kV air	In compliance	Floors should be wood, concrete, or ceramic tile. If floors are covered with synthetic material, the relative humidity should be at least 30%.
Electrical fast transient/burst IEC 61000-4-4	± 2 kV for power supply lines 100 kHz repetition frequency	In compliance	Mains power quality should be that of a typical hospital environment.
Surge IEC 61000-4-5	± 1 kV line(s) to line(s) ± 2 kV line(s) to earth	In compliance	Mains power quality should be that of a typical hospital environment.
Voltage dips, short interruptions and voltage variations on power supply input lines IEC 61000-4-11	0% U_T ; 0.5 Cycle At 0°, 45°, 90°, 135°, 180°, 225°, 270°, and 315° 0% U_T ; 1 cycle and 70% U_T ; 25/30 cycles Single Phase: at 0°	In compliance	Mains power quality should be that of a typical hospital environment. If the user of the system requires continued operation during power mains interruptions, it is recommended that the system be powered from an uninterruptible power supply or a battery.
Rated power frequency magnetic fields IEC 61000-4-8	30 A/m Frequency 50/60 Hz	In compliance	Power frequency magnetic fields should be at levels characteristic of a typical location in a typical hospital environment.
Conducted RF IEC 61000-4-6	3 Vrms 150 kHz to 80 MHz 6Vrms in ISM bands 150 kHz to 80 MHz 80% AM at 1 kHz	In compliance	Portable and mobile RF communications equipment should be used no closer to any part of the system, including cables, than the recommended separation distance calculated from the equation applicable to the frequency of the transmitter. Recommended separation distance d (m) $d=1.2 \sqrt{P}$

Table 14. Guidance and Manufacturer’s Declaration—Electromagnetic Immunity

The system is intended for use in the electromagnetic environment specified below. The customer or the user of the system should ensure that it is used in such an environment.

IMMUNITY TESTS	IEC 60601 TEST LEVEL	COMPLIANCE LEVEL	ELECTROMAGNETIC ENVIRONMENT – GUIDANCE
Radiated RF IEC 61000-4-3	3 V/m 80 MHz to 2.7 GHz 80% AM at 1 kHz	In compliance	Interference may occur in the vicinity of equipment marked with the following symbol: 

Note: U_T is the AC mains voltage prior to application of the test level.

These guidelines may not apply in all situations. Electromagnetic propagation is affected by absorption and reflection from structures, objects and people.

Accessory Conformance to Standards

To maintain electromagnetic interference (EMI) within certified limits, the system must be used with the cables, components, and accessories specified or supplied by Verathon. For additional information, see the [Parts & Accessories](#) section on page 10 and [Component Specifications](#) section on page 27. The use of accessories or cables other than those specified or supplied may result in increased emissions or decreased immunity of the system.

Table 15. EMC Standards for Accessories

ACCESSORY	MAX LENGTH
GlideScope Core QuickConnect Cable	1.57 m (5.1 ft)

Glossary

The following table provides definitions for specialized terms used in this manual or on the product itself. For a full list of caution, warning, and informational symbols used on this and other Verathon products, please refer to the Verathon Symbol Directory at verathon.com/service-and-support/symbols.

TERM	DEFINITION
A	Ampere
AC	Alternating current
AER	Automated endoscope reprocessor
C	Celsius
CFR	Code of Federal Regulations (U.S.)
CISPR	International Special Committee on Radio Interference
cm	Centimeter
CSA	Canadian Standards Association
DL	Direct laryngoscopy
DLT	Double-Lumen tube
EMI	Electromagnetic interference
ESD	Electrostatic discharge
Essential performance	The system performance necessary to achieve freedom from unacceptable risk
ET Tube	Endotracheal tube
F	Fahrenheit
g	Gram
GHz	Gigahertz
HDMI	High-definition multimedia interface
hPa	Hectopascal
Hz	Hertz
IEC	International Electrotechnical Commission
in	Inch
ISM	Industrial, scientific, and medical
ISO	International Standards Organization.
ISO connector	An endotracheal tube connector designed according to ISO standards.
kHz	Kilohertz
kPa	Kilopascal
kV	Kilovolt
L	Liter
m	Meter
mAh	Milliampere-hour
MDD	Medical Device Directive

TERM	DEFINITION
MHz	Megahertz
mm	Millimeter
mmHg	Millimeters of mercury
non-powered accessory	Endoscopic tool that does not require its own source of electrical power
OSHA	Occupational Safety and Health Administration (federal agency in U.S.)
powered accessory	Endoscopic tool that requires its own source of electrical power
RF	Radio frequency
RH	Relative humidity
SDS	Sodium dodecyl sulphate
V	Volt
Vrms	Voltage root mean squared
W	Watt
WEEE	Waste electrical and electronic equipment

verathon